

Wilbur and Orville Wright

★ ★ ★ ★ ★ ★ ★ ★ ★ ★ ★ ★ ★ ★ ★ ★
★ ACTIVITY BOOKLET ★

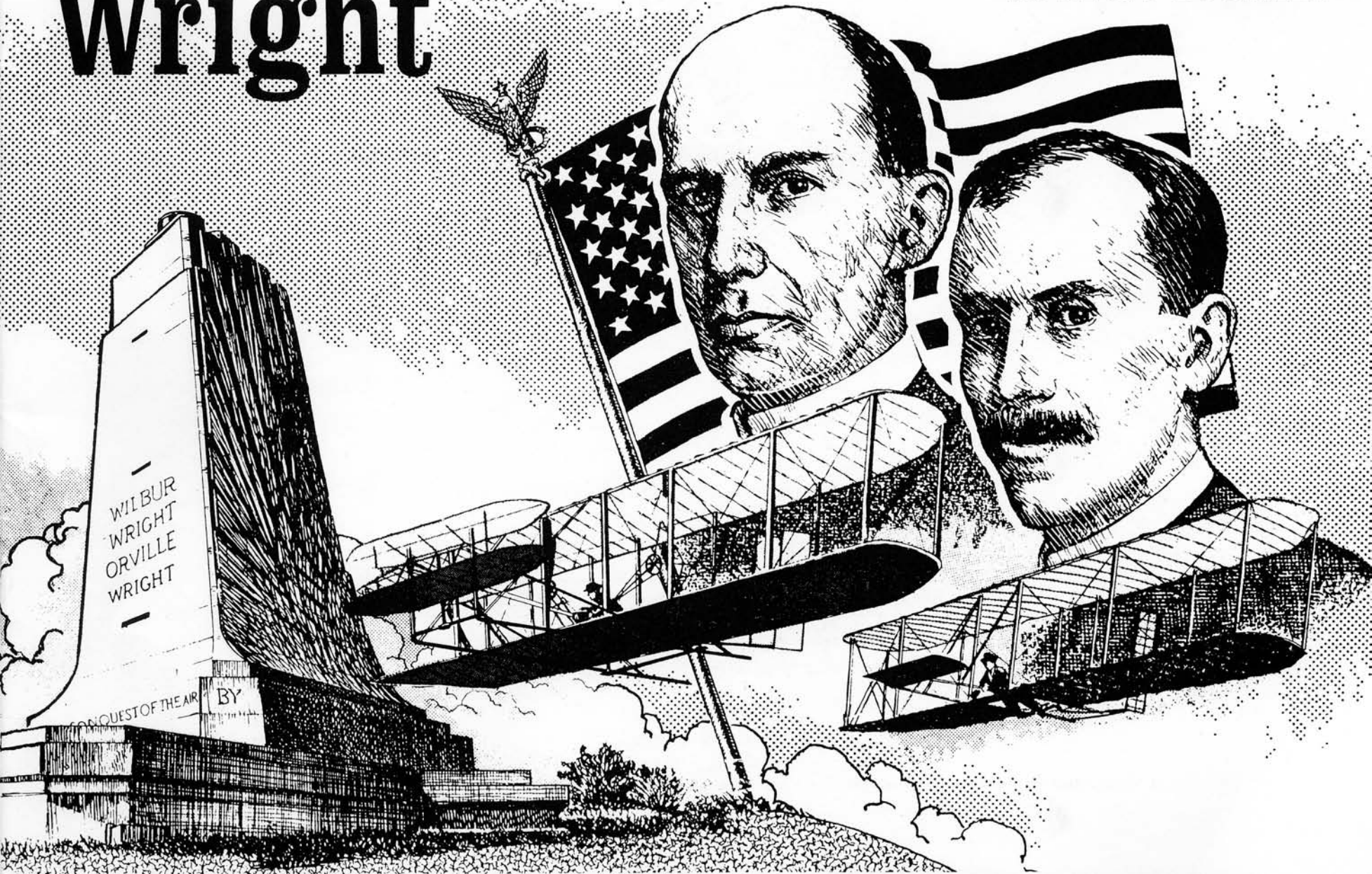



published by

NATIONAL HEADQUARTERS
CIVIL AIR PATROL
MAXWELL AFB, ALABAMA

AEROSPACE EDUCATION & TRAINING DIRECTORATE

A single copy of this publication may be ordered on school letterhead from:

NAT'L HQ CAP/ETA
Maxwell AFB AL 36112-6332
Telephone: (334) 953-5092

ORVILLE and WILBUR WRIGHT'S EARLY LIFE



THEIR FATHER'S
NAME WAS
MILTON WRIGHT.
HE WAS A MINISTER.

WILBUR WAS BORN
IN 1867.

THEIR MOTHER'S
NAME WAS
SUSAN CATHERINE
KOERNER WRIGHT.

ORVILLE WAS BORN IN
1871.

THEY FIRST BECAME INTERESTED
IN FLYING AFTER THEIR FATHER
GAVE THEM A TOY HELICOPTER.

AS YOUNG BOYS, THE WRIGHT
BROTHERS WATCHED BIRDS
AND BUILT AND FLEW KITES.

O
H
I
O



SEEK A WORD

Find the words in the puzzle that were important to the Wright brothers.



OHIO

DAYTON

KITE

LANGLEY

CHANUTE

FLYER

FRANCE

ARMY

BICYCLES

GLIDER

NEWSPAPER

PATENT

THE WRIGHT BROTHERS GROW UP

ORVILLE AND WILBUR WRIGHT BOTH FINISHED HIGH SCHOOL. NEITHER OF THEM WENT TO COLLEGE.

ORVILLE BUILT HIS OWN PRINTING PRESS WHILE HE WAS IN HIGH SCHOOL. WILBUR JOINED ORVILLE AND PRINTED A NEWSPAPER.

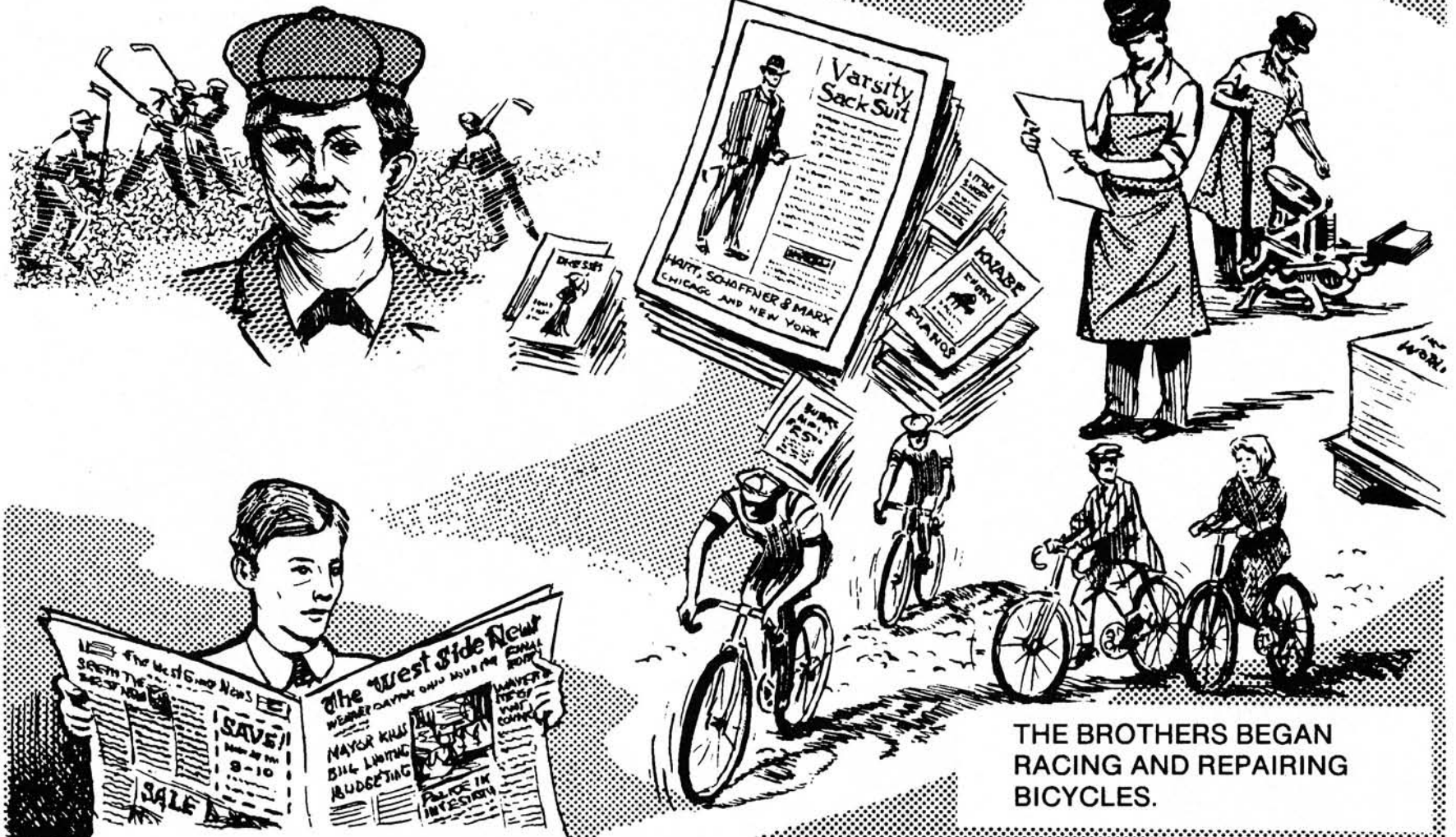

THE BROTHERS BEGAN RACING AND REPAIRING BICYCLES.

MATH TREASURE HUNT

Follow the directions to find the answer to the Treasure Question—How long did the Wright *Flyer* stay in the air on its first flight?

WRITE THE NUMERALS..... DO YOUR WORK HERE!

(1) The year of the first flight _____

ADD

(2) The number of letters of the town where that flight took place _____

SUBTRACT

(3) The year Wilbur was born _____

DIVIDE BY

(4) Five _____

MULTIPLY BY

(5) The number of words in the state where the first flight took place _____

ADD

(6) The day of the month of the first flight _____

MULTIPLY BY

(7) The number of letters in the first name of the oldest brother _____

SUBTRACT

(8) The number that stands for bicentennial _____

ADD

(9) The number of wings on the *Flyer* _____

ANSWER _____ seconds

1892

THE WRIGHT BROTHERS OPENED A BICYCLE SHOP.
THEY BEGAN TO BUILD AND REPAIR BICYCLES.

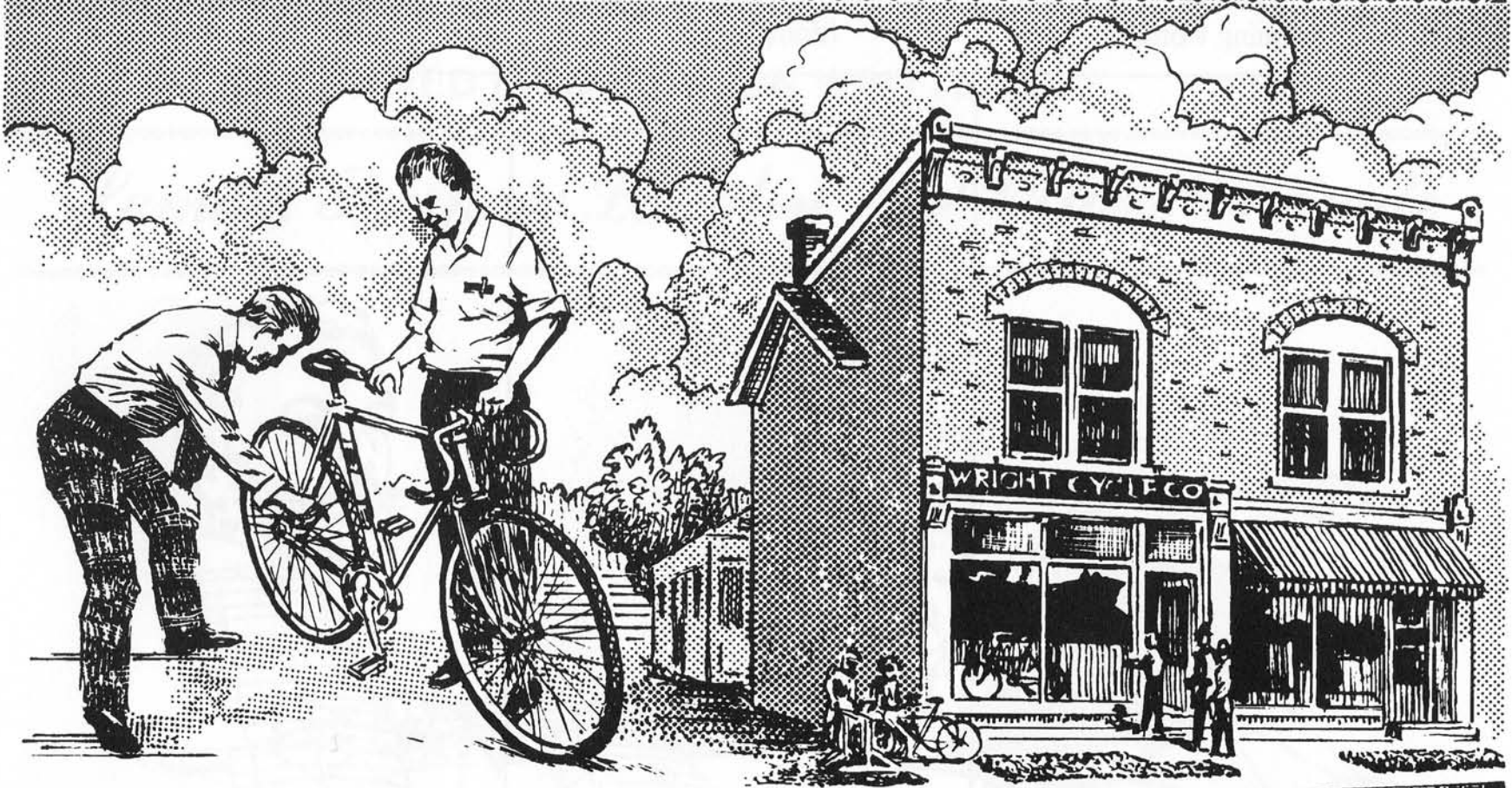

LATER ON, THE BICYCLE SHOP WAS USED TO WORK ON THEIR GLIDERS
AND AIRPLANES.

How many words can you make from WILBUR and ORVILLE WRIGHT?

Nouns (naming words)	Verbs (doing words)	Adjectives & Adverbs (describing words)

1899

THE WRIGHT BROTHERS DECIDED TO
STUDY FLYING.

THEY RECEIVED INFORMATION WRITTEN BY...

Samuel Pierpont Langley and Octave Chanute

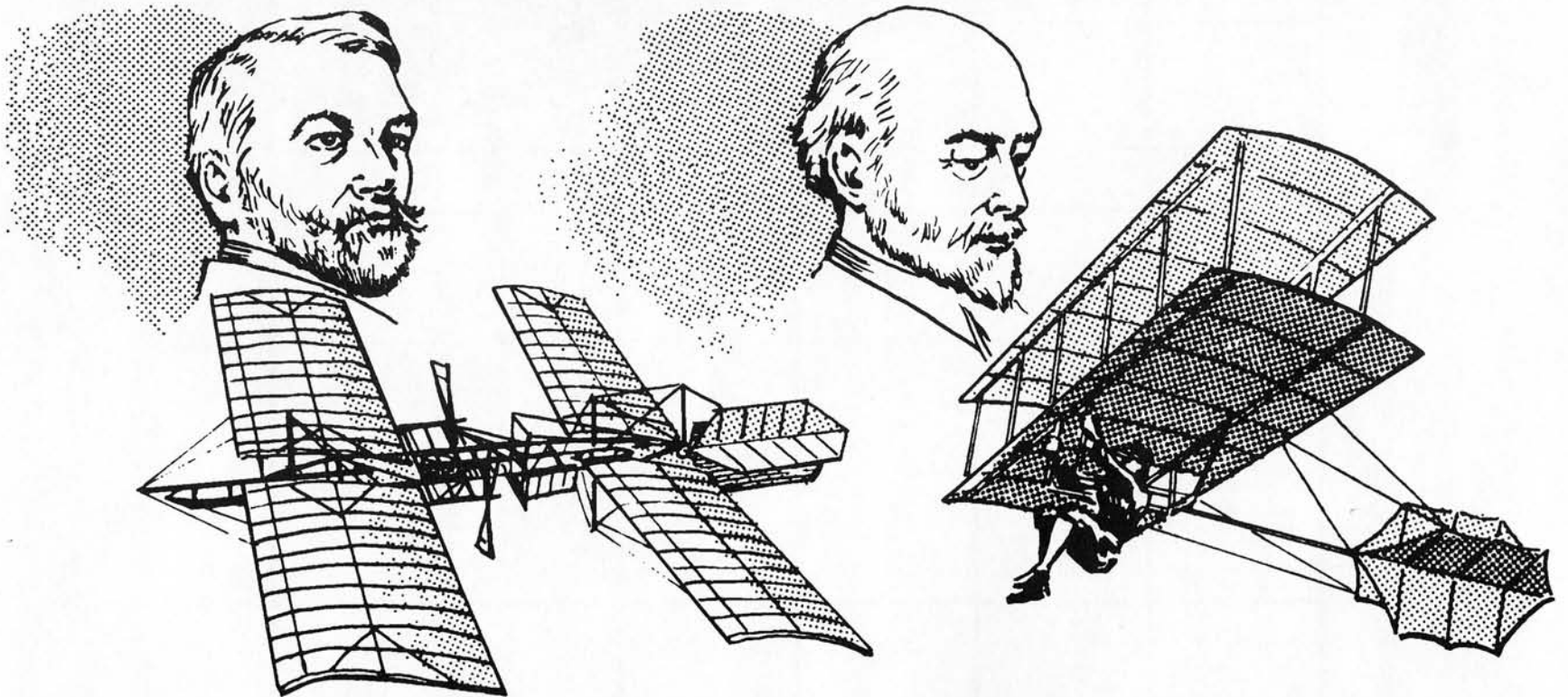

AFTER READING ALL THEY COULD FIND ABOUT FLIGHT,
THE WRIGHT BROTHERS DECIDED TO BUILD A GLIDER.

COPY THE WRIGHT GLIDER

Use the blank grid to draw your own Wright glider.

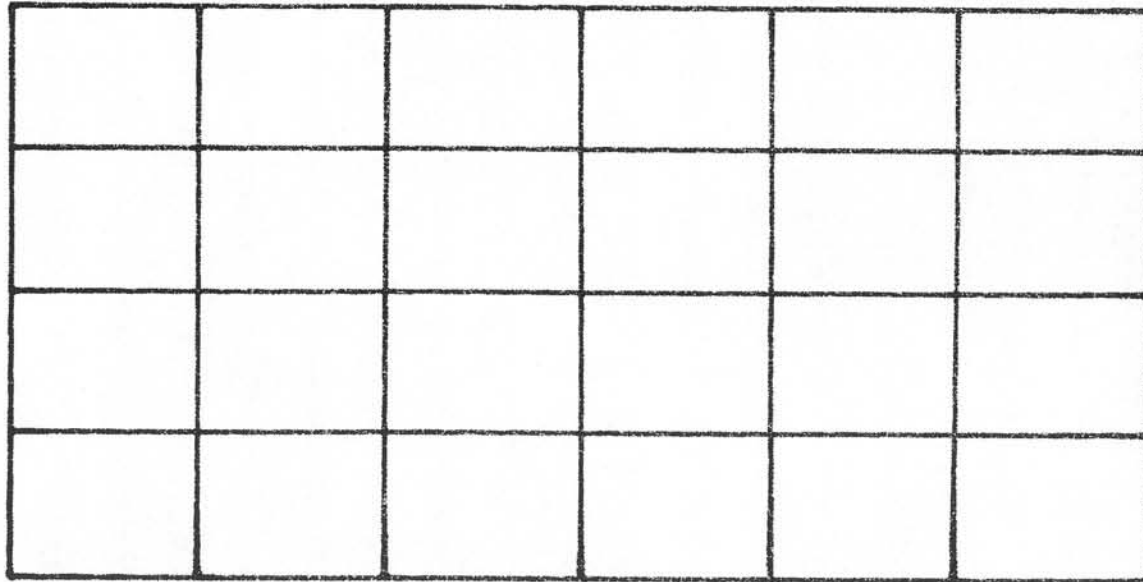
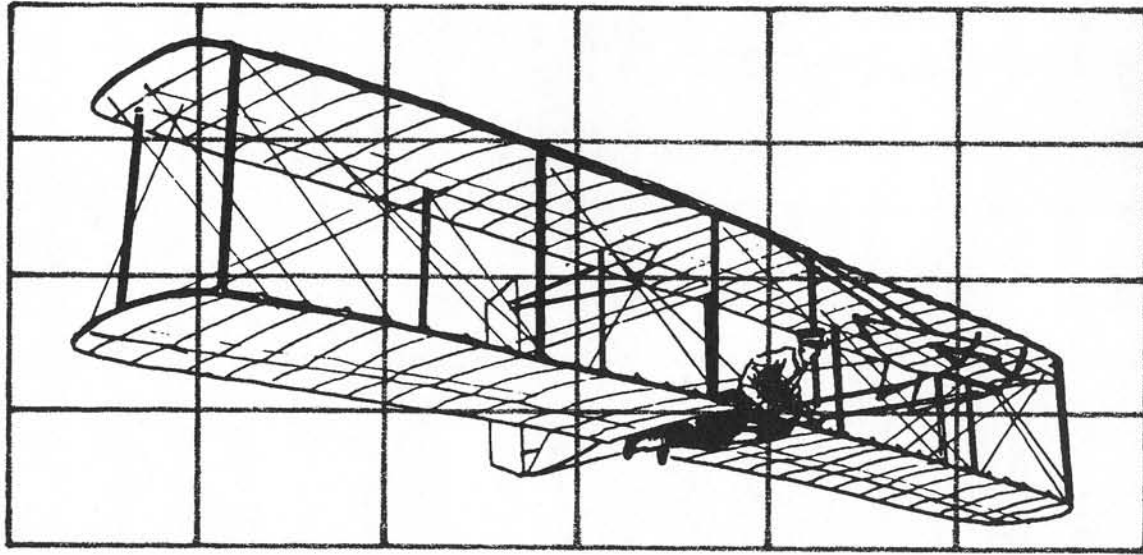

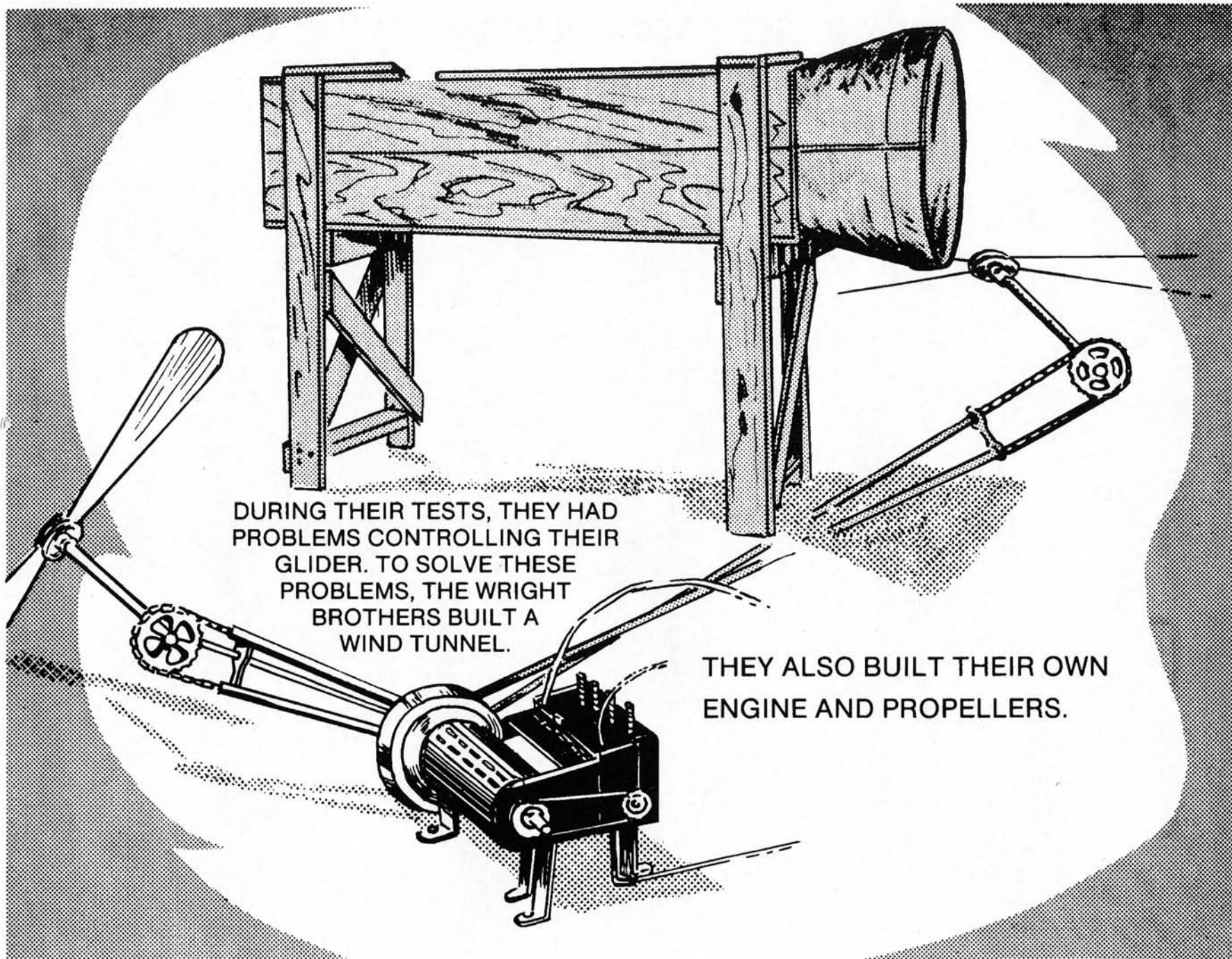

DURING THEIR TESTS, THEY HAD PROBLEMS CONTROLLING THEIR GLIDER. TO SOLVE THESE PROBLEMS, THE WRIGHT BROTHERS BUILT A WIND TUNNEL.

THEY ALSO BUILT THEIR OWN ENGINE AND PROPELLERS.

HELP THE WRIGHT BROTHERS FIND THEIR WAY TO KITTY HAWK

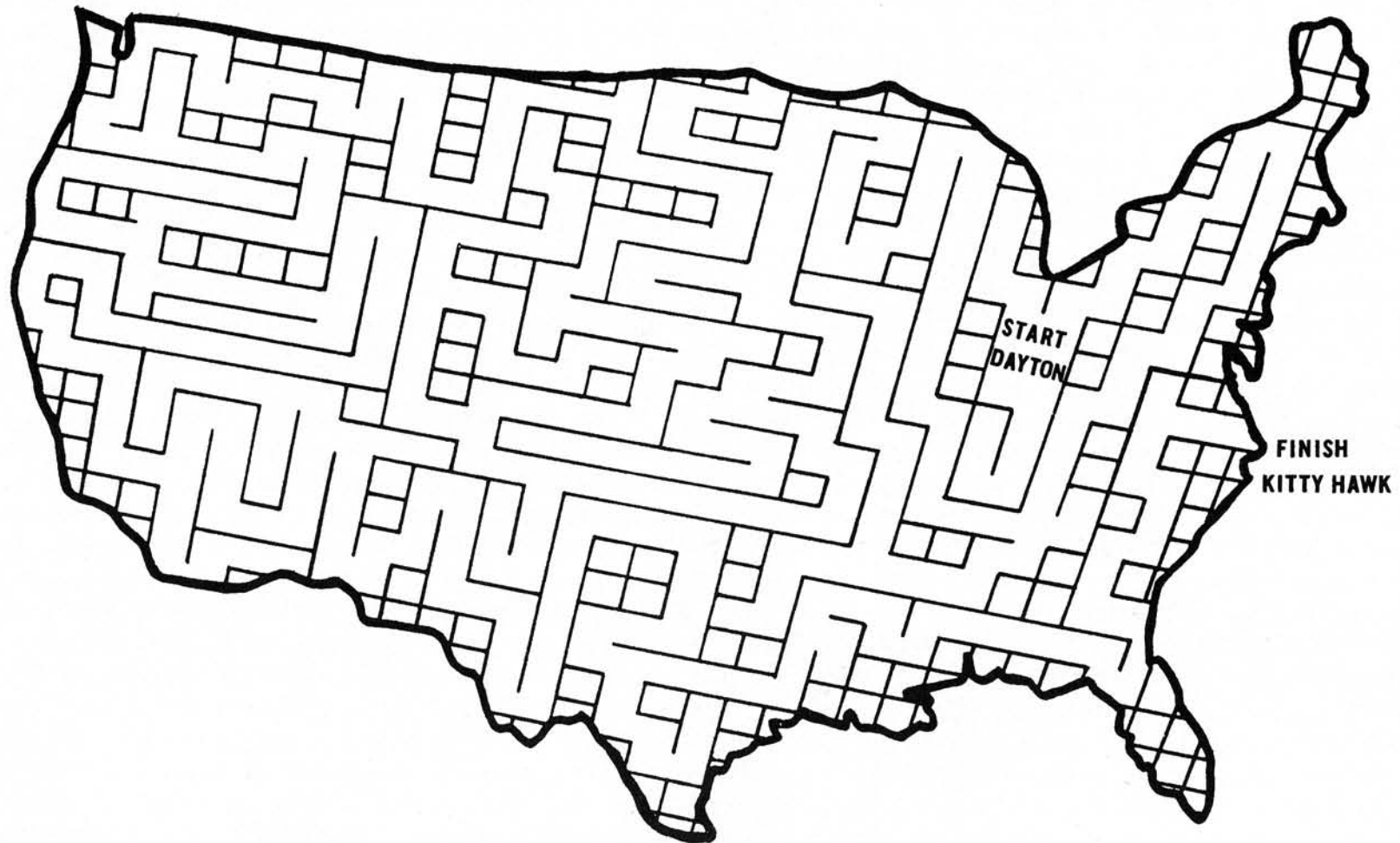

THEY NEEDED A PLACE WHERE THE WIND WAS STRONG AND STEADY TO TEST THEIR GLIDER. THE WEATHER BUREAU SUGGESTED THE SAND DUNES AROUND KITTY HAWK, NORTH CAROLINA.

1901



1902

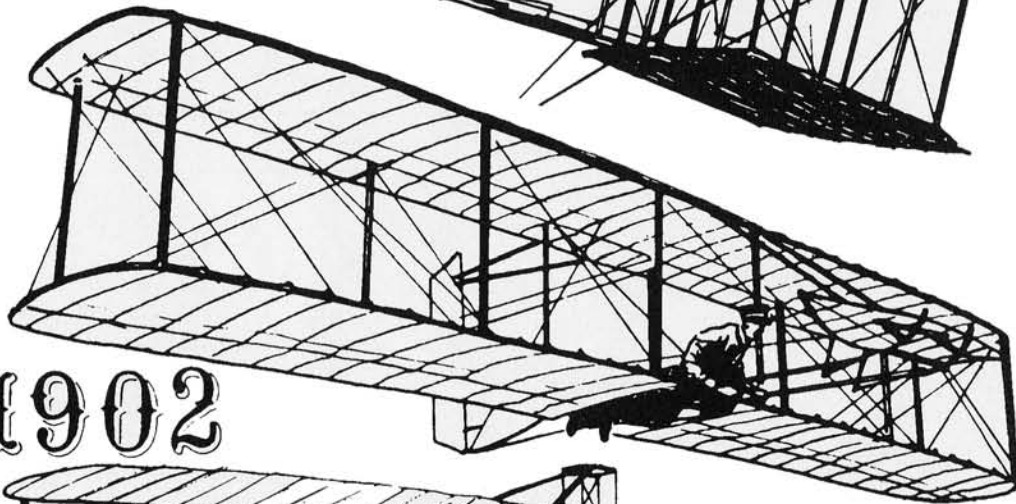

1903

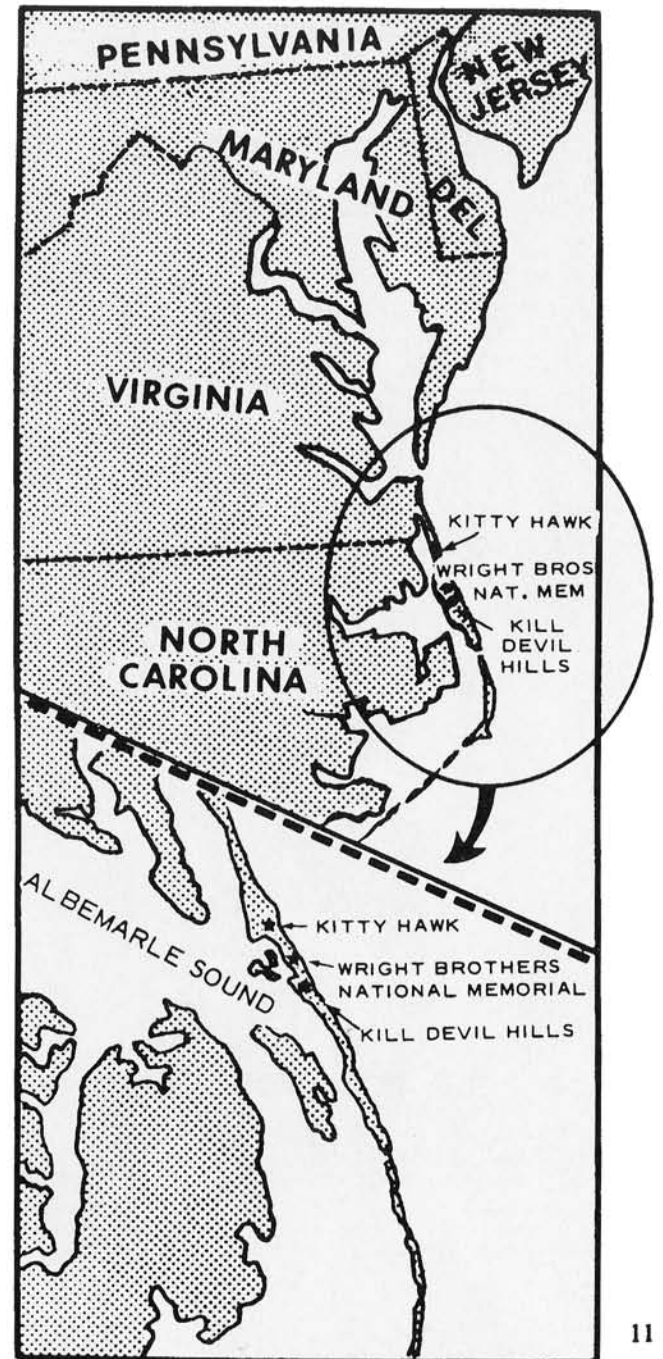
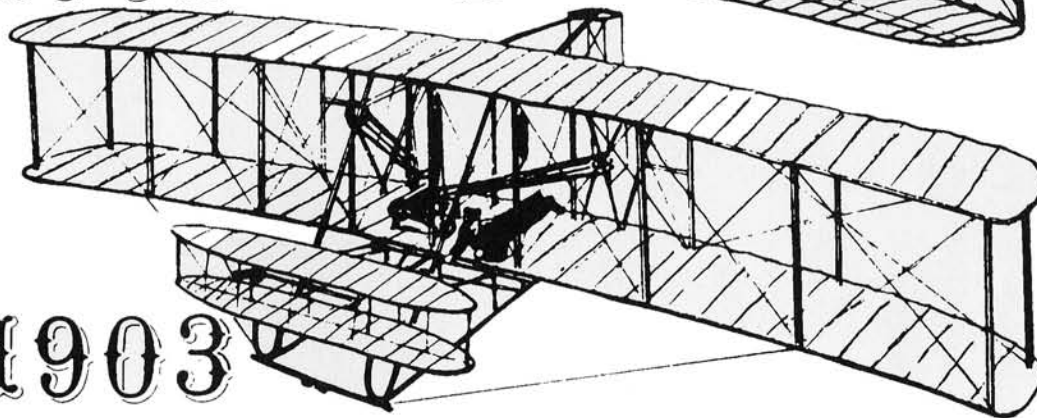

MAKE A WORD

Add and subtract letters to discover important things and people in the Wright brothers' work in aviation.

1. window - ow tundra - dra + nellie - lie = _____

2. October - ober + a + vent - nt Chanel - el + u + ten - n = _____

3. biology - ology + cycling - ing + e cream - eam + maze - m = _____

4. grass - r - s + oh - h + line english - lish + marine - mar = _____

5. pow wow - wow + ere + deed - eed fly - y + mighty - m - y = _____

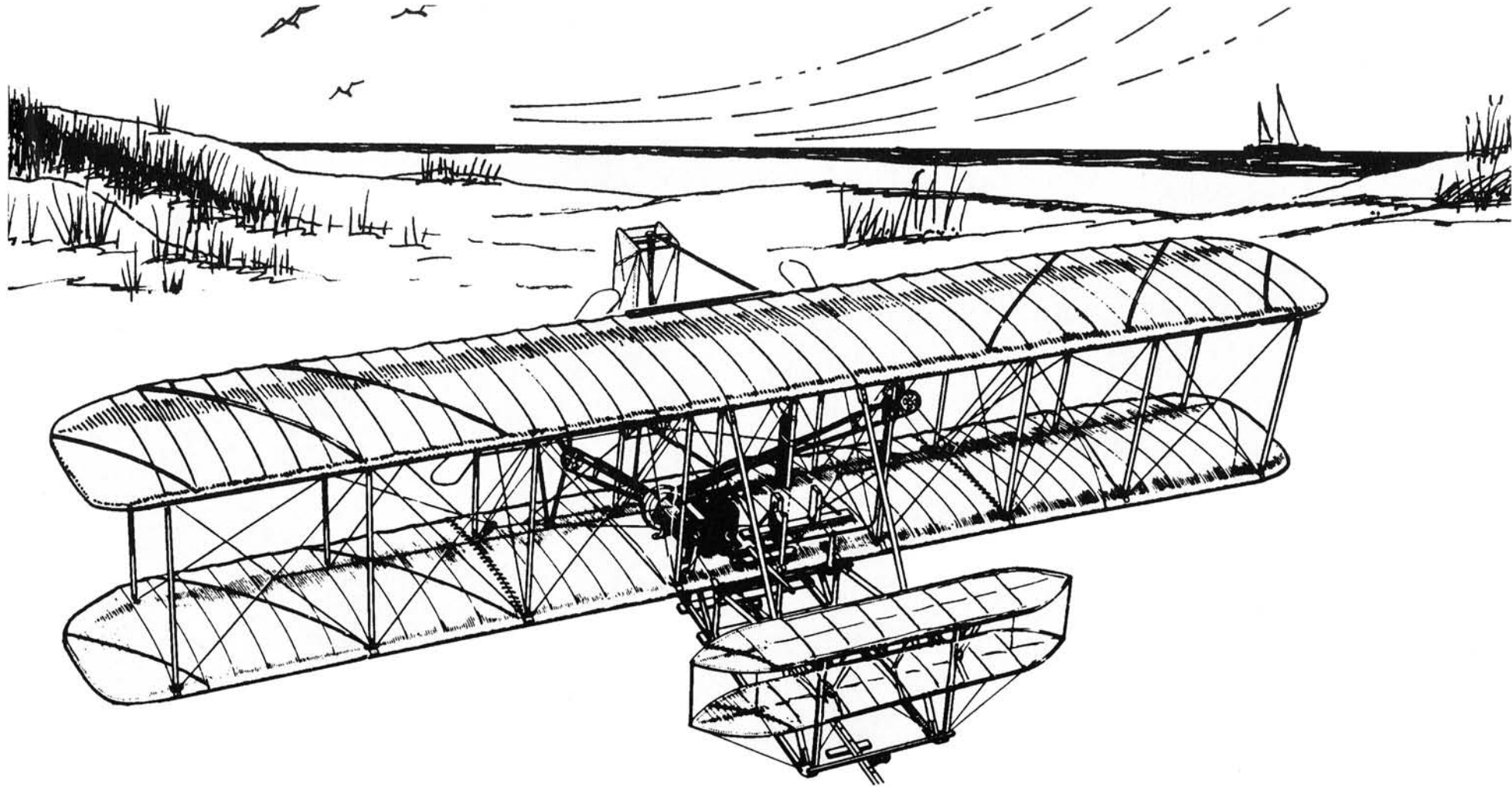

IN THE WINTER OF 1903, THE WRIGHT BROTHERS RETURNED TO NORTH CAROLINA WITH THEIR AIRPLANE WHICH THEY NAMED THE *FLYER*.

The 1903 Wright *Flyer*

ON DECEMBER 17, 1903, THE *FLYER* FLEW SUCCESSFULLY.

THIS WAS THE FIRST CONTROLLED POWERED FLIGHT OF A HEAVIER-THAN-AIR AIRPLANE IN HISTORY.

THE WRIGHT *FLYER* CROSSWORD PUZZLE

ACROSS

1. The last name of Wilbur.
3. Another word for breezy.
5. A famous museum in Washington, D.C.
6. The brother of Wilbur.
7. Another word for creation or discovery.
9. _____ Carolina.
10. The month in which the first controlled powered flight of a heavier-than-air airplane took place.
12. Go fly a _____
13. Paris, _____
14. The season the first controlled powered flight of a heavier-than-air airplane took place.

DOWN

2. One, _____, three, etc.
4. Opposite of no.
6. Dayton, _____
7. Opposite of out.
8. Another name for a hotel, motel, or lodge.

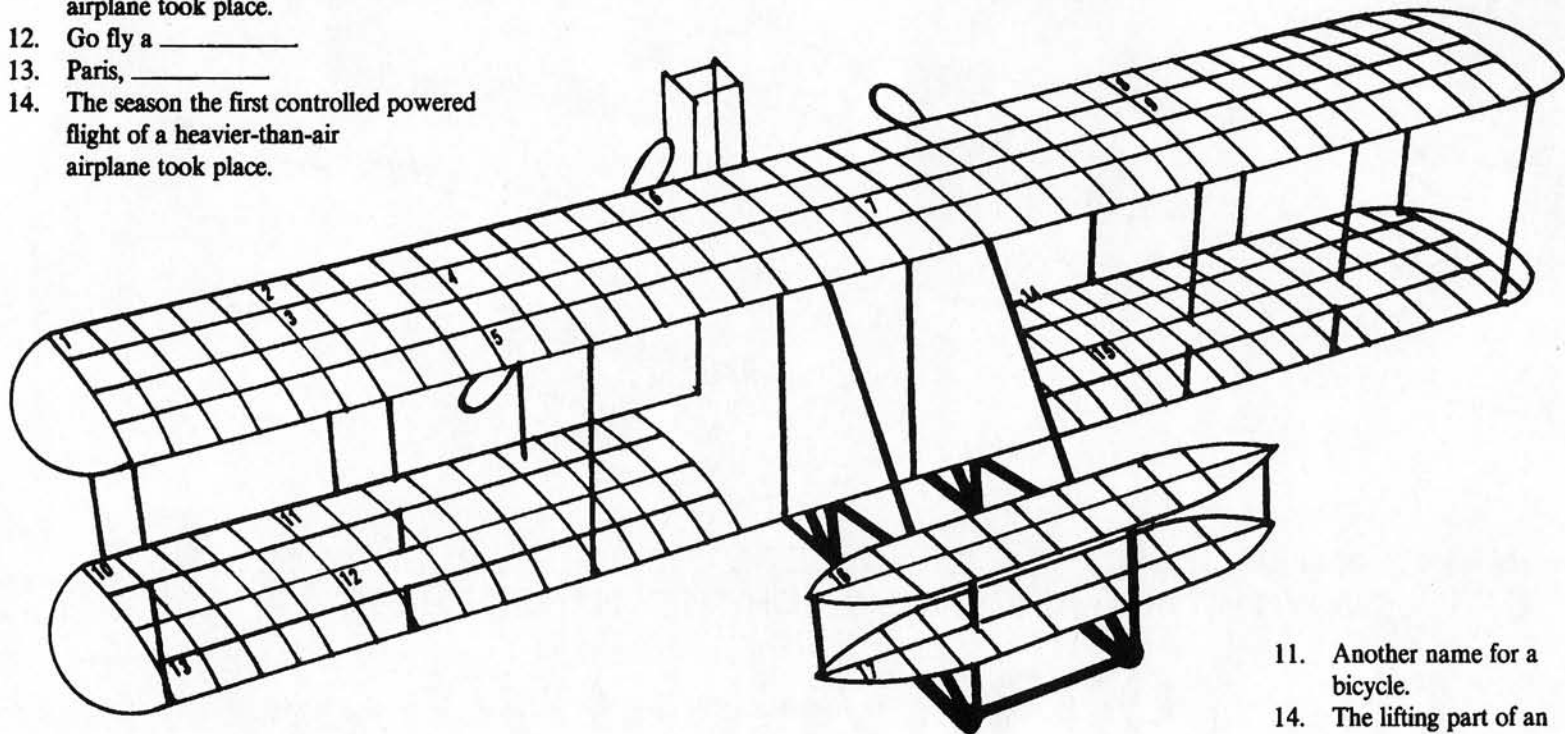

15. The state where Kitty Hawk is located.
16. Samuel Pierpont _____
17. Octave _____

11. Another name for a bicycle.
14. The lifting part of an airplane.

In 1908, the Wrights signed a contract to conduct flight tests for the U.S. Army. The tests were successful and the Army bought one of their airplanes.

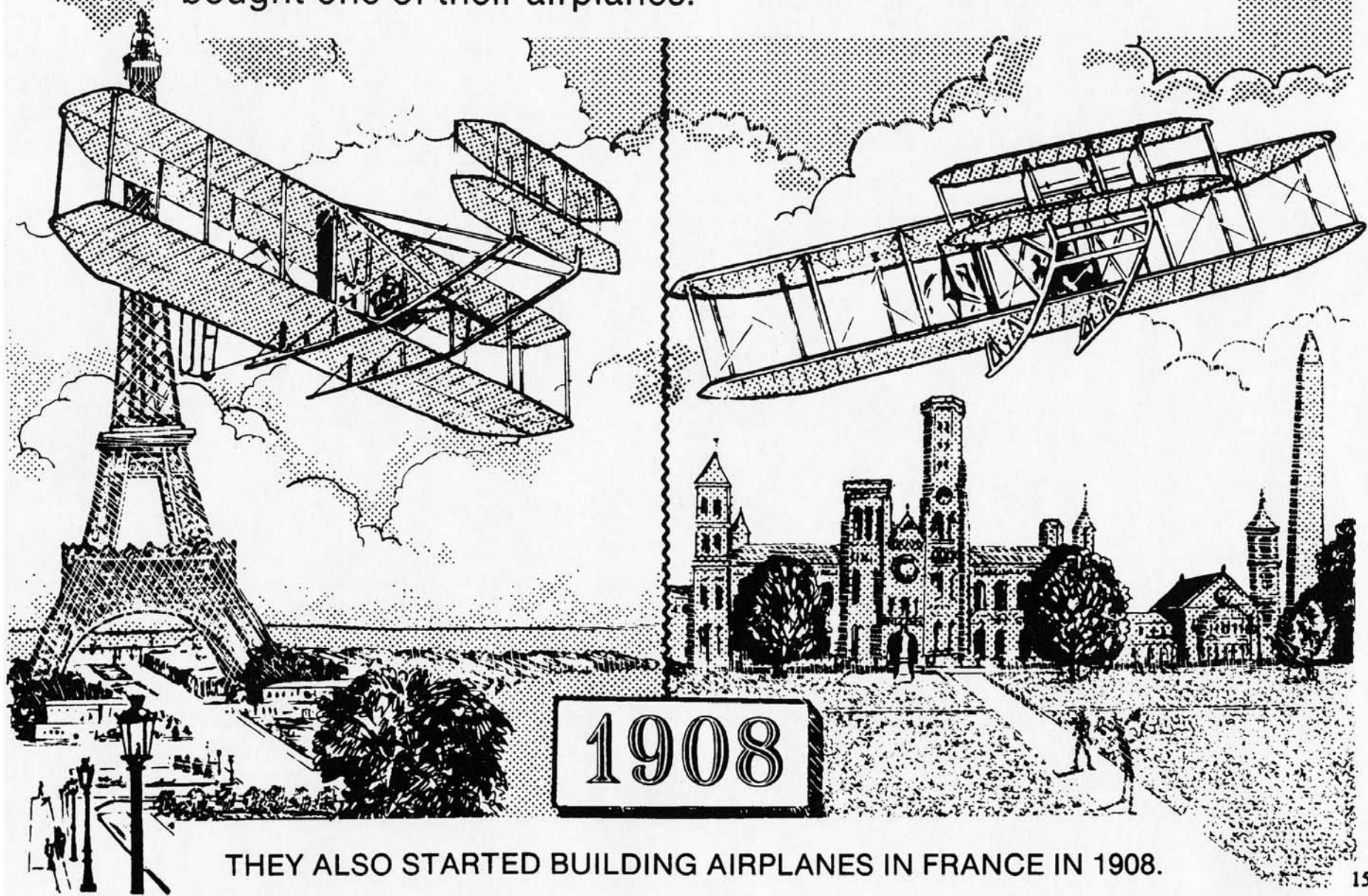

THEY ALSO STARTED BUILDING AIRPLANES IN FRANCE IN 1908.

NUMBER CHALLENGE

Using important dates in the Wright brothers' lives, reorganize each number to make the highest number you can.

1903

1917

1915

1909

1910

1908

1907

For added fun, add them all up. Now, what is the total number? _____

Can you write it in words? _____

THE WRIGHT BROTHERS
STARTED A NEW APPROACH
TO AVIATION.

WILBUR DIED IN MAY 1912.

ORVILLE WORKED IN HIS PRIVATE
LABORATORY UNTIL HE DIED IN
JANUARY 1948.

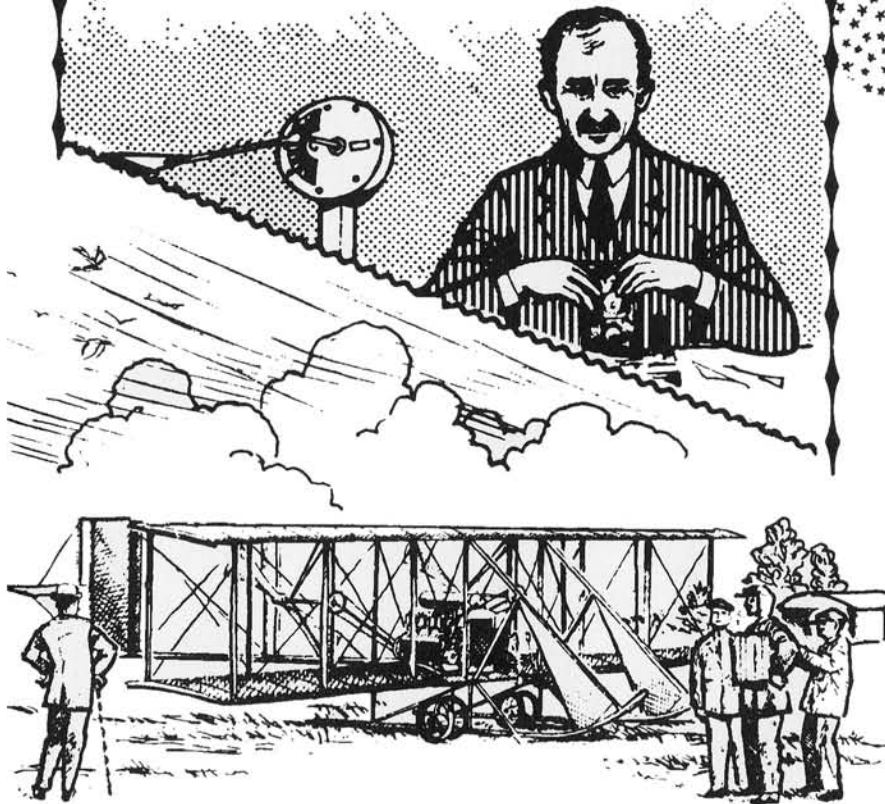

WRIGHTS' 1909 IMPROVED VERSION HAD A
30-HORSEPOWER ENGINE.



POSTER SHOWING THE
FIRST INTERNATIONAL AVIATION
MEET IN THE UNITED STATES.

WRIGHTS' MEMORIAL

Fill in the puzzle with the things shown in the picture.

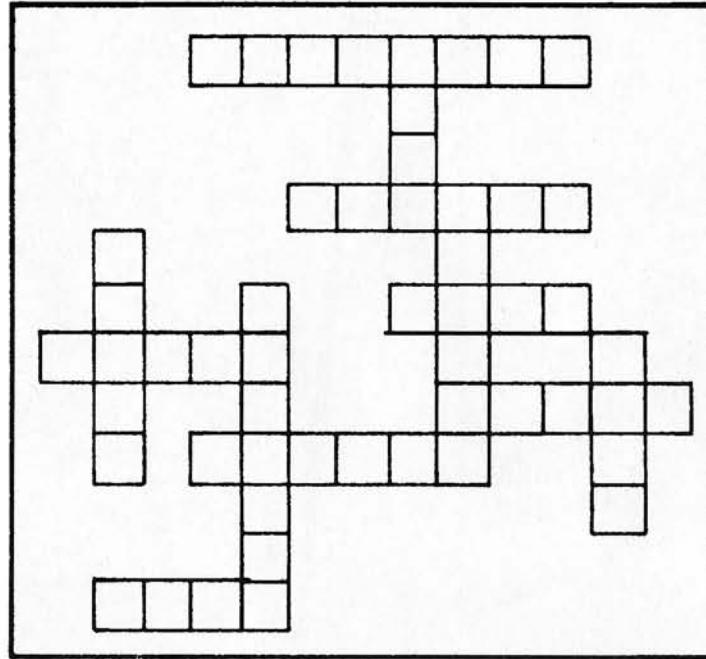

ORVILLE EAGLE KITE HANGAR CLOUD MONUMENT
WILBUR WING FLAG GLIDER MOTOR MOON

Wilbur and Orville Wright

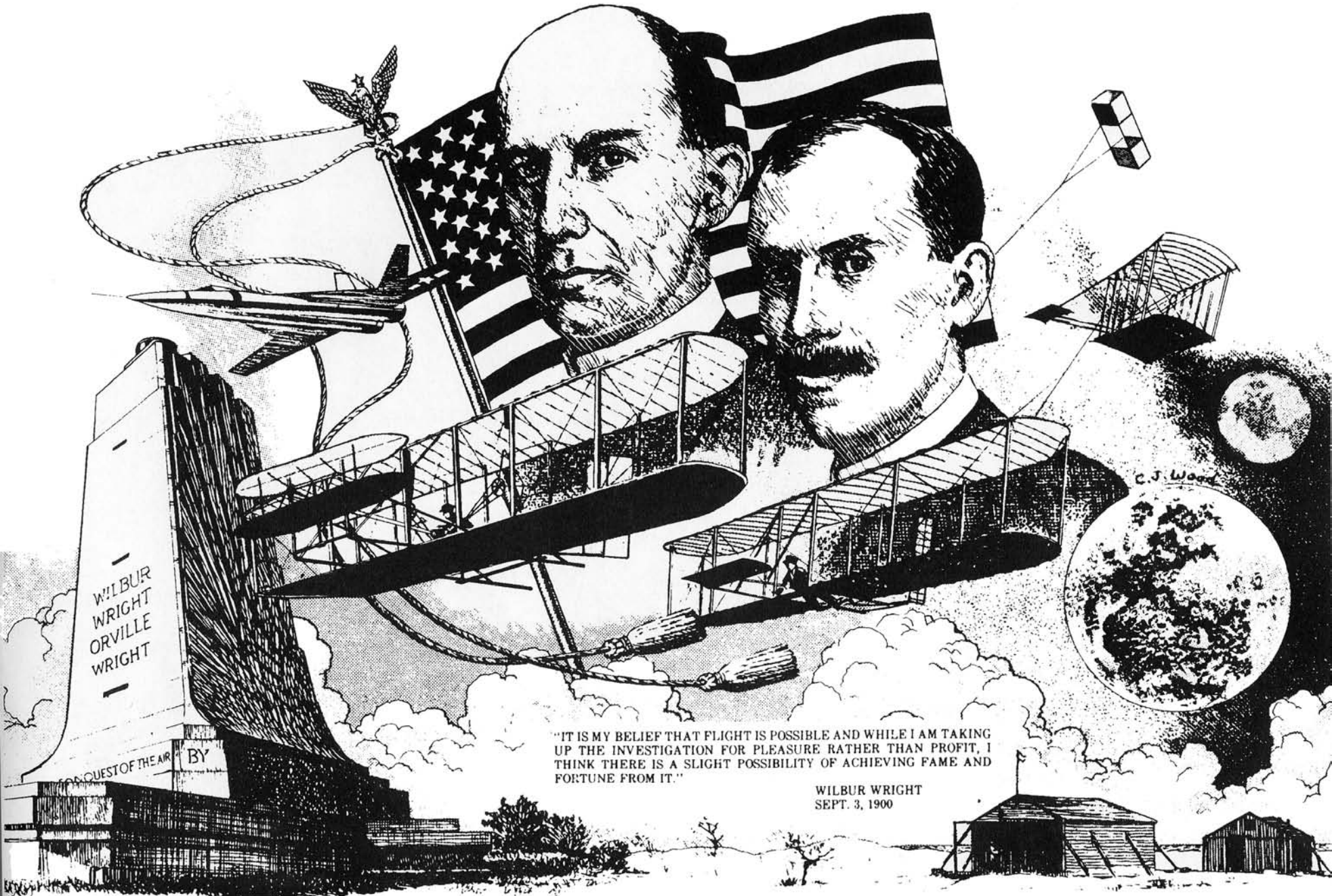

"IT IS MY BELIEF THAT FLIGHT IS POSSIBLE AND WHILE I AM TAKING UP THE INVESTIGATION FOR PLEASURE RATHER THAN PROFIT, I THINK THERE IS A SLIGHT POSSIBILITY OF ACHIEVING FAME AND FORTUNE FROM IT."

WILBUR WRIGHT
SEPT. 3, 1900

ANSWERS TO ACTIVITIES

Pg. 2 SEEK A WORD

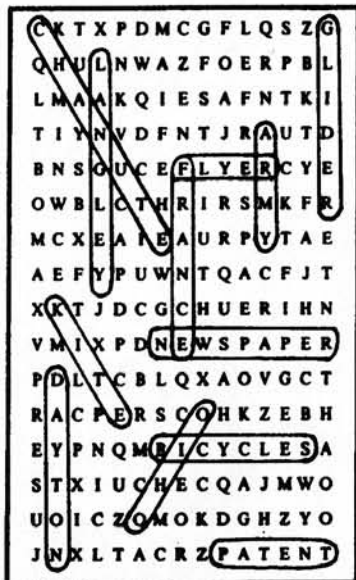

Pg. 4 MATH TREASURE HUNT

$1903 + 9$ (Kitty Hawk) = $1912 - 1867 = 45 \div 5 = 9 \times 2$ (North Carolina)
 $= 18 + 17 = 35 \times 6$ (Wilbur) = $210 - 200 = 10 + 2 = 12$

Answer — 12 Seconds

Pg. 12 MAKE A WORD

- 1) wind tunnel
- 2) Octave Chanute
- 3) bicycle craze
- 4) gasoline engine
- 5) powered flight

Pg. 10 HELP THE WRIGHT BROTHERS FIND THEIR WAY TO KITTY HAWK

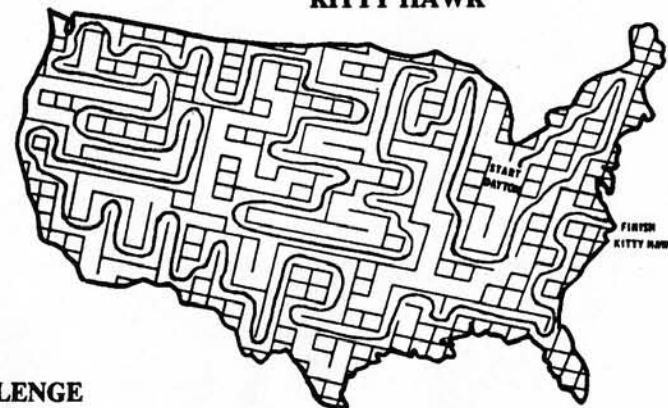

Pg. 16 NUMBER CHALLENGE

9310, 9711, 9511, 9910, 9110, 9810, 9710
 Total = 67,072 — sixty-seven thousand and seventy-two

Pg. 14 THE WRIGHT FLYER CROSSWORD PUZZLE

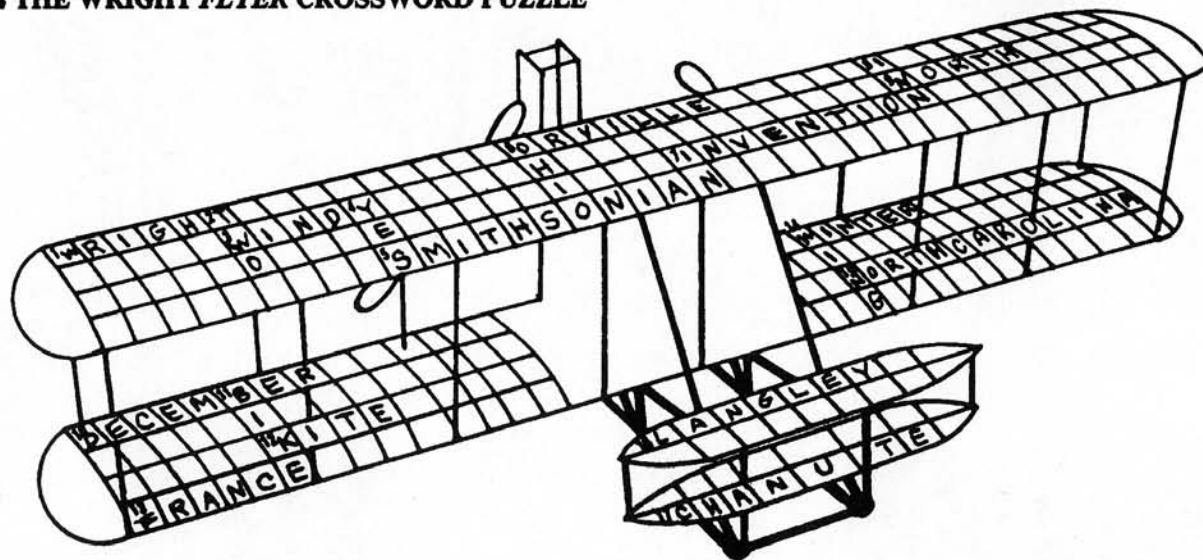

Pg. 18 WRIGHTS' MEMORIAL

