



CLEARED FOR TAKEOFF

Would you like to be a pilot?

Every year, thousands of people from all walks of life learn to fly planes. You can too! In the United States, more than 650,000 pilots fly every year, recording more than 24 million flying hours a year.

Many pilots fly for the sheer joy of flight. Others fly because it is a fast, convenient form of transportation.

Most pilots hold a private pilot's certificate, which is a student pilot's first goal. Afterwards, they can train to earn an instrument rating or to become a commercial pilot, flight instructor, or airline transport pilot.

What are the requirements to become a pilot?

First, you must be at least 16 years old to be a student pilot and at least 17 years old to receive an airplane or rotorcraft pilot's certificate. Glider and balloon pilots must be at least 14 years old to be a student pilot and 16 years old to earn a pilot's certificate.

Second, to fly an airplane or rotorcraft, you must pass a physical exam from a medical examiner designated by the Federal Aviation Administration.

Third, you must be able to speak, read, and understand the English language.

How can you become a pilot?

To become a pilot, you first start out as a student pilot and complete two types of instruction: **ground school training and flight training.**

What is ground school?

In ground school, you learn the principles of flight, aircraft instruments, systems and performance, meteorology and weather patterns, navigation, radio communications, flight planning and regulations.

What is flight training?

Flight training begins with lessons in a training aircraft with a flight instructor. When the instructor believes you are ready, you will fly your first solo flight, putting into practice all the knowledge you've gained in ground school.

Where can you take lessons?

Flight schools are located at most general aviation airports. Many offer a short introductory flight lesson to prospective students. Check your local telephone directory for "aircraft schools" or get an updated list of Minnesota flight schools from the Mn/DOT Office of Aeronautics' Web site: <http://www.mndot.gov>, then click on "Aviation."

Many colleges and universities offer aviation programs in which students can learn to fly as part of their degree programs. Visit <http://www.avcollege.info> to receive more information on aviation programs in Minnesota colleges and universities.



What are flying lessons like?

When you begin your lessons, you will fly with an instructor in a single-engine, two-seat or four-seat training aircraft.

Right from the beginning, you will do most of the actual flying. From takeoff and climbout to turning the aircraft, your instructor will allow you to operate the controls. At first you will fly a straight and level course, keeping the wings level and pointing the plane's nose at a spot on the horizon.

As your lessons continue, you will guide the airplane in gentle turns, moving gradually to steeper ones.

After a few lessons, you will perform takeoffs and landings while you practice other maneuvers. Eventually, you will be ready to fly the airplane on your unforgettable first solo flight.

How does an airplane fly?

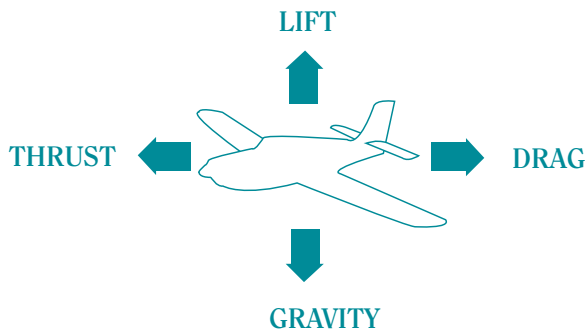

Four basic aerodynamic forces act upon an airplane during flight: **LIFT**, **GRAVITY**, **THRUST**, and **DRAG** (see diagram above).

LIFT is generated by the wings, which function as airfoils. An airfoil is any surface (such as a wing) that interacts with a moving stream of air to provide aerodynamic force.

The wings on an airplane have more camber (curvature) on the upper portion than on the lower portion. Camber causes air to flow more quickly over the top of the wing than underneath it.

One of the primary laws of lift is Bernoulli's Principle (shown below), which states that as the velocity of a fluid (in this case, air) increases, its pressure decreases.

As the wing separates the airflow, it creates an area of decreased pressure above the wing as compared to the air pressure below the wing. The pressure differential is the primary source of lift.

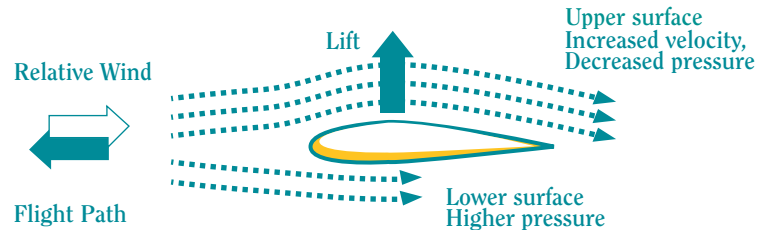

GRAVITY or **WEIGHT** is the opposing force of lift and is caused by the earth's gravitational pull on the aircraft and its contents. When enough lift is generated to overcome gravity, the aircraft becomes airborne.

THRUST is the force that propels the aircraft forward. As the amount of thrust increases, speed and lift are generated.

DRAG does the opposite thrust. The aircraft deflects air flowing around it. As thrust increases, drag increases, eventually limiting the airspeed of the plane. When thrust is greater than drag, the plane accelerates. When drag is greater than thrust, the plane slows down.

1. Spinner
2. Propeller
3. Engine Cowling
4. Windshield
5. Wing Strut
6. Wing
7. Right Aileron
8. Right Flap
9. Fuselage
10. Vertical Stabilizer
11. Rudder
12. Elevator
13. Horizontal Stabilizer
14. Left Flap
15. Left Aileron
16. Main Landing Gear
17. Door
18. Seat
19. Nose Gear
20. Landing Lights

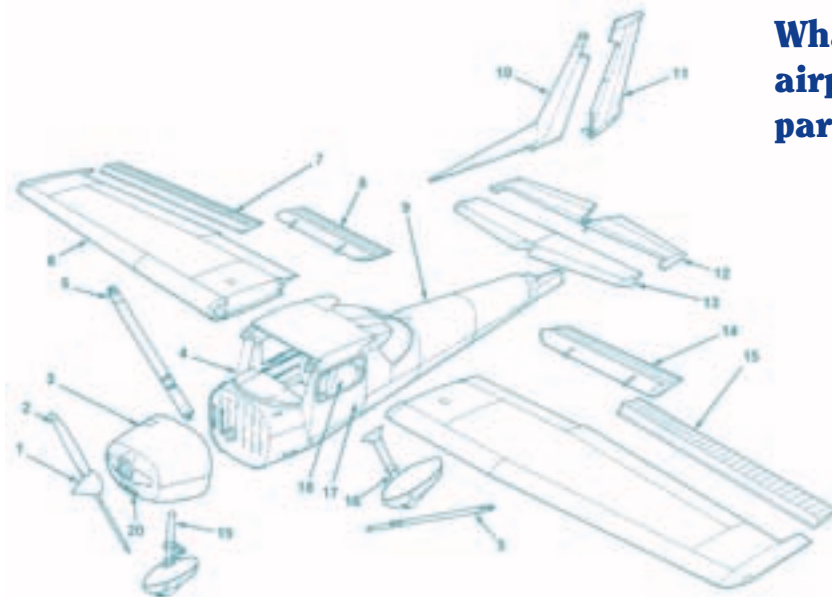

What are an airplane's major parts called?

Courtesy Cessna Aircraft Company

How does an aircraft maneuver?

Aircraft maneuver around these three axes (main lines of motion) to change a plane's direction:

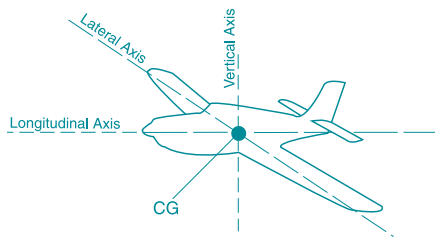

- **Lateral**
(sideways)
- **Longitudinal**
(lengthwise)
- **Vertical**
(up and down)

Pilots move the plane around each axis by adjusting the flight controls on the plane. These flight controls are:

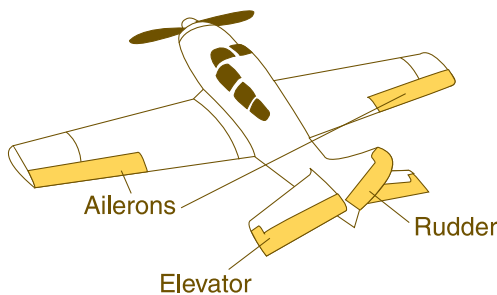

- **Ailerons**
- **Elevator**
- **Rudder**

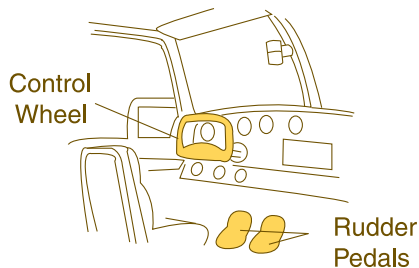

Inside the aircraft, the pilot uses the rudder pedals and control wheel (called a "yoke") to move the flight controls.

LATERAL AXIS

Plane Movement: Pitches (up and down)

Controlled by: Elevator

Connected to: Control wheel (yoke)

Pilot: Pulls back on the control wheel to climb and pushes forward to descend.

Example 1: Pull the control wheel to lift the elevator. This pushes the tail down and the nose up. The plane climbs.

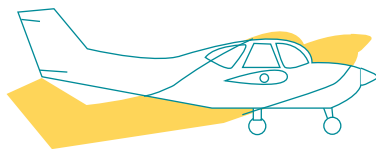

Example 2: Push the control wheel forward. The elevator goes down, the tail rises up and the nose points down. The plane descends.



LONGITUDINAL AXIS

Plane Movement: Roll (banks to either side)

Controlled by: Ailerons

Connected to: Control wheel (yoke)

Pilot: Turns the control wheel left to turn the plane left or right to turn the plane right.

Effect: One aileron goes up, lowering that wing. The other aileron goes down, lifting that wing. The plane rolls to the side that dips.

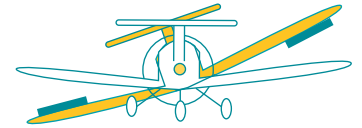

Example: Turn the yoke left. This raises the left aileron and lowers the right aileron.

The right wing lifts as the left wing dips at the same time.

The plane rolls left.

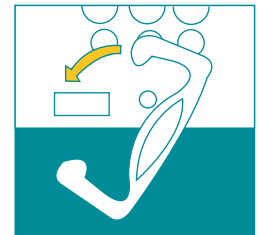

VERTICAL AXIS

Plane Movement: Yaw (turn left or right)

Controlled by: Rudder

Connected to: Rudder pedals

Pilot: Presses the left or right rudder pedal.

Effect: The rudder swings to one side. The plane's nose turns to the same side while the tail swings to the opposite side.

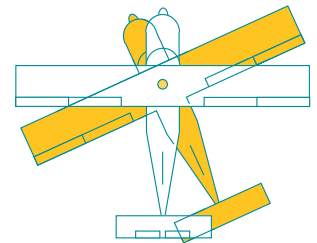

Example 1: Press the left rudder pedal. The nose moves to the left. The tail swings to the right.

Example 2: Press the right rudder to move the nose to the right. The tail swings to the left.

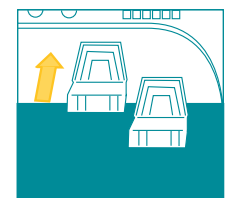

Note: Use the rudder and the ailerons together for a coordinated, smooth turn.

It looks exciting?

Yes, flying is exciting. When you begin flying lessons, you enter a whole new world. It's exhilarating, challenging, satisfying, and rewarding in ways that can enrich your life.

Experience it for yourself! What are you waiting for?

Start your flying lessons today. You're cleared for takeoff!

What instruments does the pilot use to fly the plane?

1. Airspeed Indicator

This instrument shows how fast the aircraft moves through the air; it is similar to a car speedometer.

2. Attitude Indicator

This instrument displays a tiny airplane and a horizon. It shows the position of the plane in the air relative to the horizon.

3. Altimeter

This instrument shows the aircraft's altitude in feet above sea level.

4. Turn Coordinator

This instrument features a miniature airplane inside the dial and gauges the plane's rate of turn and direction.

5. Heading Indicator

This instrument is a directional gyroscope (DG); it acts as a compass to show where the plane is headed.

6. Vertical Speed Indicator

This instrument measures air pressure during the aircraft's climb and descent.

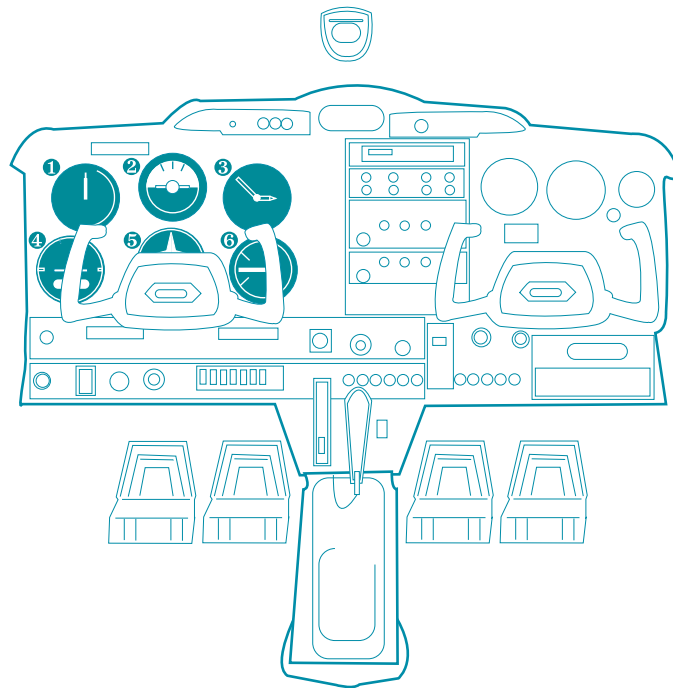

For more information about becoming a pilot, visit these helpful web sites:

Mn/DOT Aviation Education
www.dot.state.mn.us/aero/aved

Minnesota State Aviation History Museum
www.dot.state.mn.us/aero/aved/museum

Minnesota College and University Aviation Programs
www.avcollege.info

Federal Aviation Administration
www.faa.gov/education

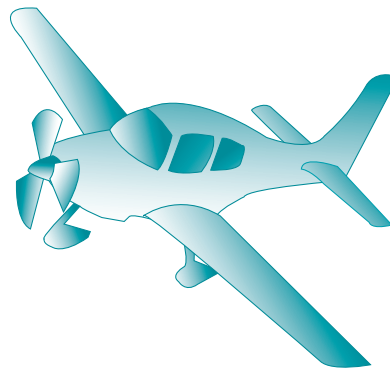

Minnesota Department of Transportation

Office of Aeronautics, Aviation Education Section
222 East Plato Boulevard, St. Paul, MN 55107-1618

www.mndot.gov | 651-234-7200 | 1-800-657-3922