

SURVEYING AND MAPPING MANUAL

TABLE OF CONTENTS

CHAPTER 1 – GENERAL

1-1	INTRODUCTION.....	1
	1-1.01 PURPOSE.....	1
	1-1.02 SCOPE.....	1
1-2	SURVEYING AND MAPPING SECTION - OFFICE OF LAND MANAGEMENT.....	1
	1-2.01 SURVEYING AND MAPPING SECTION FUNCTIONS.....	1
	1-2.02 SURVEYING AND MAPPING SECTION ACTIVITIES	1
	1-2.0201 Geodetic Unit	1
	1-2.0202 Legal Descriptions and Commissioner's Orders Unit	1
	1-2.0203 Platting Unit.....	2
	1-2.0204 Land Information System and Right of Way Mapping Unit.....	2
	1-2.0205 Survey Research and Support Unit.....	2
	1-2.0206 Photogrammetric Unit.....	2
	1-2.03 REQUESTS FOR SERVICES FROM THE SURVEYING AND MAPPING SECTION.....	3
1-3	DISTRICT SURVEYING AND MAPPING	1
	1-3.01 DISTRICT SURVEYING AND MAPPING FUNCTIONS.....	1
	1-3.02 DISTRICT SURVEYS AND MAPPING ACTIVITIES	1
	1-3.03 WORK AUTHORITIES.....	2
1-4	SURVEYS GROUP ORGANIZATION.....	1
	1-4.01 SURVEYS GROUP ADVISORY COMMITTEE.....	1
	1-4.02 SURVEYS GROUP COMMITTEE STRUCTURE	1
	1-4.0201 Equipment Committee	1
	1-4.0202 Automation Committee	1
	1-4.0203 Personnel and Training Committee.....	1

CHAPTER 2 - GEODETIC SURVEYS

2-1	INTRODUCTION.....	1
	2-1.01 PURPOSE.....	1
	2-1.02 CLASSIFICATION, STANDARDS, AND SPECIFICATIONS	1
	2-1.0201 Primary Control (First and Second Order).....	2
	2-1.0202 Secondary Control (Third Order).....	3
	2-1.0203 Supplemental Control.....	3
	2-1.03 GEODETIC CONTROL OPERATIONS IN MINNESOTA	3
	2-1.0301 National Geodetic Survey (NGS).....	3
	2-1.0302 Mn/DOT Geodetic Unit.....	4
	2-1.0303 U.S. Geological Survey (USGS).....	4
	2-1.04 INTERNAL RELATIONSHIPS.....	4
	2-1.0401 Mn/DOT District Surveys	4
	2-1.05 EXTERNAL RELATIONSHIPS.....	5
	2-1.0501 National Geodetic Survey (NGS).....	5
	2-1.0502 U.S. Geological Survey (USGS).....	5
	2-1.0503 County Highway Engineers and County Land Surveyors.....	5
	2-1.0504 Private Consultants	6
2-2	GEODETIC PRODUCTS AND SERVICES.....	1
	2-2.01 NATIONAL GEODETIC SURVEY (NGS)	1
	2-2.0101 NGS Filing System.....	1
	2-2.0102 NGS Information Center.....	2
	2-2.0103 NGS Triangulation Diagrams	3
	2-2.0104 Control Leveling Index (CLI) Maps	3
	2-2.0105 NGS/USGS Geodetic Control Diagrams.....	3

2-2.02	U.S. GEOLOGICAL SURVEY (USGS).....	3
2-2.0201	USGS Filing System	4
2-2.0202	USGS Quadrangle Maps	4
2-2.0203	USGS Digital Orthophotos.....	5
2-2.0204	USGS Horizontal Data Quads.....	6
2-2.0205	USGS Vertical Data Quads.....	6
2-2.03	MINNESOTA DEPARTMENT OF TRANSPORTATION (Mn/DOT).....	6
2-2.0301	Mn/DOT Geodetic Control Mark Index Maps.....	7
2-2.0302	Mn/DOT District Control Mark Index Maps.....	7
2-2.0303	Mn/DOT Geodetic Database	7
2-2.0304	Mn/DOT Horizontal Control Report	8
2-2.0305	Mn/DOT Vertical Control Report.....	8
2-2.0306	Mn/DOT Mark Maintenance Report	8
2-3	GEODETIC MONUMENTATION AND MARK PRESERVATION	1
2-3.01	HISTORY OF GEODETIC CONTROL MARKS	1
2-3.02	THREE DIMENSIONAL MONUMENTS	1
2-3.03	HARN MONUMENTATION	3
2-3.04	VERTICAL CONTROL MARKS - BENCH MARKS	5
2-3.0401	General Instructions for Setting Vertical Control Marks.....	5
2-3.0402	Setting Precast Marks and Poured Concrete	7
2-3.0403	Setting Marks in Structures	7
2-3.0404	Setting Rod and Disk Marks.....	8
2-3.0405	Recovery of Vertical Control Marks.....	8
2-3.0406	Resetting Vertical Control Marks.....	8
2-3.0407	Report on Relocation of Bench Mark (NOAA 76-60).....	9
2-3.05	HORIZONTAL CONTROL MONUMENTS	9
2-3.0501	General Instructions for Setting Horizontal Control Marks.....	9
2-3.0502	Setting Poured Concrete Marks	11
2-3.0503	Setting Marks in Structures	12
2-3.0504	Recovery of Horizontal Control Marks	13
2-3.0505	Resetting Marks - Raising or Lowering a Station In Place	13
2-3.0506	Relocating Marks - Moving a Station.....	16
2-3.0507	Project Report	16
2-3.06	DESCRIPTIONS OF GEODETIC CONTROL MARKS	16
2-3.0601	Description of Geodetic Control Marks	17
2-3.07	RECOVERY OF 3D CONTROL MARKS	20
2-3.08	PRESERVING GEODETIC CONTROL MARKS	21
2-3.0801	Witnessing Marks	21
2-3.0802	Notification of Proposed Construction Plans and Pending Mark Destruction ..	21
2-3.09	FUTURE OF GEODETIC MONUMENTATION	21
2-3.0901	Continuously Operating Reference Stations (CORS).....	21
2-3.0902	Traditional Geodetic Marks	22
2-4	HORIZONTAL CONTROL.....	1
2-4.01	GEODETIC DATUMS.....	1
2-4.02	COORDINATE SYSTEMS`	3
2-4.0201	Geodetic Position (Latitude, Longitude)	4
2-4.0202	Universal Transverse Mercator Projection (UTM).....	5
2-4.0203	Minnesota State Plane Coordinate System.....	5
2-4.0204	Project Coordinate System.....	6
2-4.0205	County Coordinate System	6
2-4.03	Mn/DOT PRIMARY HORIZONTAL CONTROL SURVEYS.....	7
	(NGS PUBLISHED FIRST ORDER).....	7
2-4.0301	Field Specifications and Records	8
2-4.0302	Office Data Processing.....	10
2-4.04	Mn/DOT SECONDARY HORIZONTAL CONTROL SURVEYS (THIRD ORDER)	12
2-4.0401	Field Specifications and Records	12
2-4.0402	Mn/DOT Least-Squares Horizontal Adjustment.....	12

2-4.05 SUPPLEMENTAL HORIZONTAL CONTROL SURVEYS 13
 2-4.0501 *Field Specifications and Records* 13

2-5 VERTICAL CONTROL..... 1

2-5.01 ELEVATION DATUMS 1
 2-5.0101 *National Geodetic Vertical Datum of 1929 (NGVD 29)*..... 1
 2-5.0102 *North American Vertical Datum of 1988 (NAVD 88)*..... 1

2-5.02 NETWORK DESCRIPTIONS 2

2-5.03 MN/DOT PRIMARY VERTICAL CONTROL SURVEYS 2
 (NGS PUBLISHED) 2
 2-5.0301 *Field Specifications and Records* 3
 2-5.0302 *Collimation Constant, “C”* 7
 2-5.0303 *Office Data Processing*..... 9

2-5.04 MN/DOT SECONDARY VERTICAL CONTROL SURVEYS 10
 2-5.0401 *Field Specifications and Records* 10
 2-5.0402 *Reciprocal Leveling*..... 13

2-5.05 SUPPLEMENTAL VERTICAL CONTROL SURVEYS 13
 2-5.0501 *Field Specifications and Records* 14

2-5.06 FUTURE OF VERTICAL CONTROL 15

2-6 THE GLOBAL POSITIONING SYSTEM..... 1

2-6.01 INTRODUCTION 1

CHAPTER 3- LAND SURVEYS

3-1 INTRODUCTION..... 1

3-2 ORGANIZATION 1

3-3 PUBLIC LAND SURVEYS/PRIVATE BOUNDARY CORNERS..... 1

3-1 INTRODUCTION..... 1

3-2 ORGANIZATION..... 1

3-3 PUBLIC LAND SURVEY/PRIVATE BOUNDARY CORNERS..... 1

3-3.01 RECORD RESEARCH 1
 3-3.0101 *U.S. Government Survey Records*..... 1
 3-3.0102 *State Survey Records* 2
 3-3.0103 *County Survey Records*..... 3
 3-3.0104 *Township and City Records*..... 3
 3-3.0105 *Private Records and Local Knowledge* 4

3-3.02 FIELD RESEARCH 4
 3-3.0201 *Verification of Record Evidence*..... 4
 3-3.0202 *Reconnaissance of Occupation Lines and Roads* 5
 3-3.0203 *Interviews – Property Owners & Local Residents*..... 5
 3-3.0204 *Search for Unrecorded Monuments* 6

3-3.03 MONUMENT PERPETUATION 7

3-3.04 ANALYSIS..... 7
 3-3.0401 *Methods For Determining Position of Government Corners* 7

3-3.05 PUBLIC LAND CORNER MONUMENTATION 8
 3-3.0501 *Government Monuments*..... 8
 3-3.0502 *Private Land Surveyor Monuments* 8
 3-3.0503 *Reference Ties and Witness Posts* 8

3-4 CERTIFICATE OF LOCATION OF GOVERNMENT CORNERS..... 1

3-4.01 INSTRUCTIONS FOR PREPARATION OF CERTIFICATE OF LOCATION OF GOVERNMENT CORNERS 1

3-4.02 FILING OF CERTIFICATE OF LOCATION OF GOVERNMENT CORNER..... 2

3-4.03 MN/DOT CORNER CERTIFICATE POLICY 3

3-5 R/W BASE MAP 1

3-5.01 SPECIFICATIONS 1

3-5.02 PREPARATION..... 1
 3-5.0201 *Map Content*..... 1
 3-5.0202 *Text Annotation* 2

3-6 RIGHT OF WAY STAFF AUTHORIZATION MAP 3

3-7 RIGHT OF WAY PLATS 1

 3-7.01 ACQUISITION PLATS..... 1

 3-7.0101 Computation of Boundary Corners 1

 3-7.0102 Plat Development 3

 3-7.0103 Plat Monumentation 4

 3-7.0104 Final Preparation of Plats..... 4

 3-7.0105 Certification and Signatures..... 4

 3-7.0106 Reproduction and Distribution..... 5

 3-7.0107 Plat Revisions..... 5

 3-7.02 PROPERTY SURVEY MAP 6

 3-7.03 MONUMENTATION PLAT..... 6

3-8 R/W ACQUISITION BY METES AND BOUNDS DESCRIPTIONS..... 1

3-9 FINAL R/W MAP 1

3-10 SPECIAL SURVEYS 1

 3-10.01 SITE SURVEYS 1

 3-10.02 REGISTERED LAND SURVEYS..... 1

 3-10.03 RECONVEYANCE SURVEYS 1

 3-10.0301 Survey of Critical Topography 1

 3-10.0302 Establish Land Ties 1

 3-10.0303 Establish Line Data For Description 1

3-11 TURNBACKS..... 1

 3-11.01 SURVEY OF CRITICAL TOPOGRAPHY 1

 3-11.02 ESTABLISH LAND TIES 1

 3-11.03 ESTABLISH LINE DATA FOR DESCRIPTION 1

 3-11.04 TURNBACK AUTHORIZATION MAP 1

3-12 MISCELLANEOUS MARKING OF RIGHT OF WAY BOUNDARIES..... 1

 3-12.01 R/W STAKING FOR VIEWING OR APPRAISING 1

 3-12.02 R/W STAKING AT THE REQUEST OF ADJOINING PROPERTY OWNERS 1

 3-12.03 R/W STAKING FOR PRIVATE LAND SURVEYORS 1

CHAPTER 4 - PHOTOGRAMMETRY

4-1 INTRODUCTION..... 1

 4-1.01 PURPOSE..... 1

 4-1.02 ORGANIZATION OF SERVICES 2

 4-1.0201 Planning Group..... 2

 4-1.03 DEFINITIONS..... 3

4-2 PRODUCTS AND SERVICES..... 1

 4-2.01 INTRODUCTION 1

 4-2.02 AERIAL PHOTOGRAPHY 1

 4-2.0201 Vertical Aerial Photography 1

 4-2.0202 Oblique Aerial Photography 1

 4-2.03 PHOTOGRAPHIC REPRODUCTION 2

 4-2.0301 Mn/DOT Photo Lab..... 2

 4-2.0302 Contractor Photo Lab..... 2

 4-2.0303 Contact Prints..... 2

 4-2.0304 Diapositives..... 2

 4-2.0305 Photographic Indexes..... 2

 4-2.0306 Photo Enlargements 2

 4-2.0307 Digital Images 3

 4-2.04 AERIAL MOSAIC 3

 4-2.0401 Uncontrolled Mosaic 3

 4-2.0402 Semi-Controlled Mosaic..... 3

 4-2.0403 Ortho Mosaic..... 3

4-3	AERIAL PHOTOGRAPHY ACQUISITION.....	1
4-3.01	INTRODUCTION	1
4-3.02	AERIAL PHOTOGRAPHY USES	1
4-3.03	AERIAL PHOTOGRAPHY REQUESTS	1
4-3.04	AREAS TO BE PHOTOGRAPHED	2
4-3.05	TIME OF PHOTOGRAPHY	2
	4-3.0501 Spring Flying	2
	4-3.0502 Fall Flying	2
4-3.06	COORDINATION OF PHOTOGRAPHY WITH GROUND TARGETING	3
4-3.07	PRIORITIES FOR PHOTOGRAPHING PROJECT AREAS.....	3
4-3.08	ACCURACY	3
	4-3.0801 Non-Mapping Photography.....	3
	4-3.0802 Mapping Photography.....	3
	4-3.0803 Photography Specifications.....	3
4-4	PHOTOGRAMMETRIC MAPPING PROJECT PLANNING.....	1
4-4.01	PRE-SURVEY PLANNING	1
	4-4.0101 Control Targets	1
	4-4.0102 Test Targets	3
	4-4.0103 Single Strip - Any Length Horizontal Control Only (Figure 4-4.0103).....	4
	4-4.0105 Single Strip - Any Length Horizontal And Vertical Control (Figure 4-4.0105) ...	4
	4-4.0106 Bowing Deformation: Suppressed With Vertical Control (Figure 4-4.0106).....	5
	4-4.0107 Torsional Deformation: Suppressed With Vertical Control (Figure 4-4.0107) ..	5
	4-4.0108 Successive Single Strips Connected (Figure 4-4.0108).....	5
	4-4.0109 Successive Strips - Offset Overlap (Figure 4-4.0109)	6
	4-4.0110 Block Photography, Horizontal Control Only (Figure 4-4.0110).....	6
	4-4.0111 Block Photography, Horizontal And Vertical Control (Figure 4-4.0111).....	6
	4-4.0112 Target Material and Placement.....	7
	4-4.0113 Aerial Target Size	7
	4-4.0014 Target Site	8
	4-4.0115 Target Pickup	8
	4-4.0116 Extra Targets	9
4-4.02	NON-TARGET CONTROL	9
	4-4.0201 Non-Target Control: Horizontal Only.....	10
	4-4.0202 Non-Target Control: Horizontal and Vertical.....	11
	4-4.0203 Possible Problematic Control	12
4-4.03	PROJECT PLANNING - POST FLIGHT SETUP	12
	4-4.0301 Photograph Marking	13
	4-4.0302 Control Point Diagram.....	14
	4-4.0303 Control Point and Passpoint Numbering	14
	4-4.0304 Control Point Symbols.....	14
	4-4.0305 Control Point Tabulation Sheets	15
	4-4.0306 Control Point Survey Data	15
4-5	AEROTRIANGULATION.....	1
4-5.01	INTRODUCTION	1
4-5.02	MAPPING MODEL	2
4-5.03	AEROTRIANGULATION PROCEDURE	2
4-5.04	AEROTRIANGULATION ACCURACIES	4
4-5.05	AEROTRIANGULATION OUTPUT	4
4-5.06	AEROTRIANGULATION REPORT.....	4
4-5.07	PROJECT RECORD SHEET	5
4-6	DIGITAL MAP COMPILATION	1
4-6.01	INTRODUCTION	1
4-6.02	STEREOPLOTTERS/DIGITAL WORKSTATIONS	1
4-6.03	MAPPING HARDWARE AND DATA COLLECTION SOFTWARE.....	1
4-6.04	MAPPING SCALES.....	1

4-6.05	TYPES OF MAPPING	1
	4-6.0501 <i>Planimetric</i>	1
	4-6.0502 <i>Digital Terrain Model (DTM)</i>	2
	4-6.0503 <i>Contours</i>	2
4-6.06	STANDARD AND REDUCED DETAIL	2
	4-6.0601 <i>Standard Planimetric Detail</i>	3
	4-6.0602 <i>Reduced Planimetric Detail</i>	3
4-6.07	FILE TYPES	3
4-6.08	DATUMS, COORDINATE SYSTEMS	3
4-6.09	MAPPING DESIGN FILE PARAMETERS	3
4-6.10	REQUIRED FILES	3
	4-6.1001 <i>Planimetric Projects</i>	4
	4-6.1002 <i>DTM Projects</i>	4
4-6.11	STEREOMODEL SETUP PROCEDURES	4
	4-6.1101 <i>Inner Orientation</i>	5
4-6.12	PLANIMETRIC STEREOMODEL SETUP	5
4-6.13	DTM STEREOMODEL SETUP	5
4-6.14	PLANIMETRIC FEATURE COMPILATION	6
4-6.15	DTM MAP COMPILATION	6
	4-6.1501 <i>Centerpoint Data</i>	6
	4-6.1502 <i>DTM Feature Compilation</i>	7
4-7	<i>DIGITAL MAP EDITING</i>	1
4-7.01	INTRODUCTION	1
4-7.02	FILE TYPES	1
4-7.03	FILE SIZES	1
4-7.04	FILE NAMING CONVENTION.....	1
4-7.05	PLANIMETRIC FEATURE EDITING.....	1
4-7.06	GRID TICKS	2
4-7.07	MAPPING INDEX	2
4-7.08	DTM EDITING PROCEDURES.....	3
4-8	<i>MAP ACCURACY</i>	1
4-8.01	INTRODUCTION	1
4-8.02	MAP ACCURACY STANDARDS.....	1
4-8.03	MAP TESTING PROCEDURES	1
4-8.04	ACCURACY TESTING ANALYSIS	2
4-8.05	MAP ACCURACY REPORT	2
4-9	<i>MAPPING DELIVERY AND ARCHIVING</i>	1
4-9.01	INTRODUCTION	1
4-9.02	MAPPING DELIVERY.....	1
	4-9.0201 <i>Planimetric Projects</i>	1
	4-9.0202 <i>DTM Projects</i>	1
	4-9.03 <i>FILE ARCHIVING</i>	1

CHAPTER 5 - LOCATION SURVEYS

5-1	<i>INTRODUCTION</i>	1
5-2	<i>CHAPTER ORGANIZATION</i>	1
5-3	<i>ALIGNMENT</i>	1
5-3.01	INTRODUCTION	1
5-3.02	RECORD RESEARCH	1
5-3.03	RECOVERY OF ALIGNMENT MONUMENTS.....	1
5-3.04	REESTABLISHING ALIGNMENTS	2
5-3.05	NEW ALIGNMENT.....	2
5-3.06	FINAL ALIGNMENT	2
5-3.07	REFERENCE TIES	3
5-3.08	ALIGNMENT IDENTIFICATION	3

5-4	TOPOGRAPHIC SURVEYS	1
5-4.01	HORIZONTAL (PLANIMETRIC) METHODS	2
	5-4.0101 Station-Offset.....	3
	5-4.0102 Annotation	3
	5-4.0103 Electronic Topography.....	3
5-4.02	VERTICAL (RELIEF, HYPSONETRIC) METHODS	3
	5-4.0201 Profile Method.....	4
	5-4.0202 Cross-Section Method	5
	5-4.0203 Digital Terrain Model Method	6
	5-4.0204 Contour Method	6
	5-4.0205 Relative Measurements.....	6
5-4.03	STADIA METHODS	6
	5-4.0301 Transit-Rod.....	7
	5-4.0302 Total Station	7
5-5	SPECIFIC TYPES OF SURVEYS	1
5-5.01	ACCIDENT - TRAFFIC.....	1
5-5.02	AIRPORTS	1
	5-5.0201 Airport Plans	1
	5-5.0202 Field Procedures	2
	5-5.0203 Vertical Control.....	2
	5-5.0204 Property Survey.....	2
	5-5.0205 Alignment	2
	5-5.0206 Profiles	3
	5-5.0207 Contour Map	3
	5-5.0208 Topography	3
	5-5.0209 Drainage.....	4
5-5.03	BRIDGES	5
	5-5.0301 Alignment	5
	5-5.0302 Vertical Control.....	5
	5-5.0303 Roadway Profiles	5
	5-5.0304 Roadway Cross-Sections	6
	5-5.0305 Intersection Angles.....	6
	5-5.0306 Description of Inplace Bridge	6
	5-5.0307 Topography	6
	5-5.0308 Building Elevations	7
	5-5.0309 Adjacent Bridges	7
	5-5.0310 General Data for Hydraulic Engineer.....	7
	5-5.0311 Normal High Water Elevation.....	7
	5-5.0312 Determination of Extreme (Highest) High Water.....	7
	5-5.0313 Water Surface and Stream Bed Profiles for Bridges and Culverts.....	7
	5-5.0314 Stream Cross-Sections for Bridges.....	8
	5-5.0315 Stream Cross-Sections for Culverts.....	8
	5-5.0316 Photographs	9
	5-5.0317 County and Judicial Ditches.....	9
	5-5.0318 Flood Insurance Studies	9
5-5.04	COMMUNICATION TOWERS	9
5-5.05	DRAINAGE.....	9
	5-5.0501 Rural Drainage.....	9
	5-5.0502 Urban Drainage	10
5-5.06	PRESERVATION OF HISTORICAL SITES	11
	5-5.0601 Definitions of Sites.....	11
	5-5.0602 Mn/DOT Procedure.....	11
	5-5.0603 Sources of Existing Information	11
	5-5.0604 Minnesota Historical Society Field Study	11
	5-5.0605 District Site Surveys	12

5-5.07	NOISE WALLS.....	12
	5-5.0701 Baseline.....	12
	5-5.0702 Cross-Sections.....	12
	5-5.0703 Topography.....	12
	5-5.0704 Base Map.....	12
5-5.08	OVERLAYS.....	12
	5-5.0801 Alignment.....	12
	5-5.0802 Perpetuation of Public Land Survey System Corners.....	13
	5-5.0803 Information for Designer.....	13
5-5.09	PIPELINES.....	13
	5-5.0901 Ownership.....	13
	5-5.0902 Product Being Transported.....	14
	5-5.0903 Pipeline Material.....	14
	5-5.0904 Pipeline Location.....	14
5-5.10	PITS 14	
	5-5.1001 New Pits.....	15
	5-5.1002 New Borings in Existing Pits.....	15
5-5.11	RAILROAD.....	16
	5-5.1101 Record Research.....	16
	5-5.1102 Field Procedure.....	16
	5-5.1103 Alignment.....	17
	5-5.1104 Vertical Control.....	17
	5-5.1105 Intersection Angles.....	17
	5-5.1106 Profiles and Cross-Sections.....	17
	5-5.1107 Topography.....	18
	5-5.1108 Drainage.....	18
	5-5.1109 Glossary of Railroad Terms.....	19
5-5.12	SIGNAL - TRAFFIC.....	20
	5-5.1201 Data Required.....	20
5-5.13	TUNNEL.....	20
5-5.14	TURN LANES.....	21
	5-5.1401 Vertical Control.....	21
	5-5.1402 Topography.....	21
	5-5.1403 Cross-Sections.....	21
	5-5.15 UTILITIES.....	22
	5-5.1501 Office Research.....	22
	5-5.1502 Municipally Owned Utilities.....	22
	5-5.1503 Privately Owned Utilities.....	23
	5-5.1504 Field Procedures.....	23
	5-5.1505 Alignment.....	23
	5-5.1506 Vertical Control.....	23
	5-5.1507 Elevations.....	24
	5-5.1508 Topography.....	24
	5-5.1509 Profiles and Cross-Sections.....	24
5-6	MAPPING.....	I
5-6.01	INTRODUCTION.....	1
5-6.02	BASE MAP.....	1
	5-6.0201 Definition.....	1
	5-6.0202 General.....	1
	5-6.0203 Map Elements.....	2
5-6.03	NATIONAL HIGHWAY MAPPING STANDARDS.....	2
5-6.04	GENERAL MAP PLANNING.....	3
	5-6.0401 Map Leaders.....	4
5-6.05	TYPES OF MAPS MADE.....	4
	5-6.0501 Planimetric Map.....	4
	5-6.0502 Topographic Map.....	5
	5-6.0503 Design Map.....	5
	5-6.0504 Utility Map.....	5

	5-6.0505	Alignment Map	6
	5-6.0506	Drainage.....	6
	5-6.0507	Staff Approved Layout.....	6
	5-6.0508	Record Boundaries.....	7
	5-6.0509	Plats.....	9
5-6.06		TYPES OF DOCUMENTS MADE.....	9
	5-6.0601	Certificate of Location of Government Corner.....	9
	5-6.0602	Certificate of Survey.....	10
	5-6.0603	Registered Land Survey.....	10
5-6.07		BRIDGE SURVEY SHEETS	10
5-6.08		GRAVEL PIT SHEETS.....	12
5-6.09		SITE MAP	13
5-6.10		SKETCHES AND EXHIBITS	13
5-6.11		AIRPORT MAPS	14
5-7		NOTE FORMS.....	1
	5-7.01	INTRODUCTION	1
	5-7.02	STANDARDS	1
	5-7.03	FORMAT.....	2
	5-7.0301	Title Page	2
	5-7.0302	Body of Notes.....	2

CHAPTER 6 - CONSTRUCTION SURVEYS

6-1		INTRODUCTION.....	1
6-2		PRE-CONSTRUCTION	1
	6-2.01	REVIEW PLANS	2
	6-2.0101	Horizontal Alignment	2
	6-2.0102	Vertical Alignment.....	2
	6-2.0103	Typical Sections.....	3
	6-2.0104	Planned Drainage	4
	6-2.0105	Right of Way Limits	4
	6-2.0106	Utilities.....	5
	6-2.0107	Pay Item Documentation	6
6-2.02		PREPARE STAKING BOOKS	6
	6-2.0201	Alignment Book	6
	6-2.0202	Grade Book.....	6
	6-2.0203	Slope Stake Book	6
	6-2.0204	Blue Top Book.....	7
6-2.03		FIELD WORK.....	8
	6-2.0301	Alignment	8
	6-2.0302	Supplementary Bench Marks.....	8
	6-2.0303	Land Corner Ties.....	8
	6-2.0304	Check Existing Structures.....	8
6-3		CONSTRUCTION	1
	6-3.01	COMMUNICATIONS	1
	6-3.0101	Pre-Construction Conference.....	1
	6-3.0103	Surveyor-Inspector Relationship	1
6-3.02		STAKING.....	1
	6-3.0201	Clearing and Grubbing	2
	6-3.0202	Muck Excavation	3
	6-3.0203	Slope Stakes and Key Stakes.....	3
	6-3.0204	Culverts	3
	6-3.0205	Grading Blue Tops	4
	6-3.0206	Borrow Pits.....	5
	6-3.0207	Storm Sewer.....	5
	6-3.0208	Curb and Gutter	5
	6-3.0209	Paving.....	5
	6-3.0210	Fencing.....	6

	6-3.0211	Signs	6
	6-3.0212	Bridges	6
	6-3.0213	Noise Walls.....	6
6-4	POST CONSTRUCTION		1
	6-4.01	FINAL MEASUREMENTS	1
	6-4.0101	General.....	1
	6-4.0102	Final Cross Sections.....	1
	6-4.0103	Muck Excavation	1
	6-4.0104	Structures	2
	6-4.0105	Final Plans	2
	6-4.02	MONUMENTATION.....	2
	6-4.0201	Final Alignment.....	2
	6-4.0202	Right of Way.....	2
	6-4.0203	Bench Marks.....	3
	6-4.0204	Horizontal Control Stations	3
6-5	NOTE FORMS.....		1
	6-5.01	STANDARDS	1
	6-5.02	FORMAT.....	2
	6-5.0201	Title Page	2
	6-5.0202	Other Pages.....	2
	6-5.03	EXAMPLES OF NOTE FORMS	2
	6-5.0301	Alignment Notes	3
	6-5.0302	Clearing and Grubbing	3
	6-5.0303	Muck Excavation	3
	6-5.0304	Slope Stakes and Key Stakes.....	3
	6-5.0306	Blue Tops.....	3
	6-5.0307	Borrow Pits.....	4
	6-5.0308	Storm Sewer.....	4
	6-5.0309	Curb and Gutter	4
	6-5.0310	Paving.....	4
	6-5.0311	Fencing.....	4
	6-5.0312	Signs	4
	6-5.0313	Bridge Notes.....	4
	6-5.0314	Bench Levels.....	4

CHAPTER 7 - PROCUREMENT, MANAGEMENT AND MAINTENANCE OF EQUIPMENT

7-1	BUDGET AND PURCHASE		1
	7-1.01	INTRODUCTION	1
	7-1.02	BUDGET REQUEST	1
	7-1.03	REQUISITION FOR PURCHASE (OMITTED)	1
	7-1.04	PURCHASE ORDER	1
7-2	SURVEYING AND MAPPING EQUIPMENT.....		1
	7-2.01	INTRODUCTION	1
	7-2.02	FIXED ASSET (CODED) EQUIPMENT	1
	7-2.03	NON-CODED EQUIPMENT (ITEMS VALUED AT LESS THAN \$2000)	1
		Field Equipment.....	1
	7-2.04	EQUIPMENT EVALUATION.....	1
	7-2.0401	Equipment Specifications	2
	7-2.0402	Evaluation Report Form.....	2
	7-2.0403	Product/Service Problem.....	2
7-3	EQUIPMENT MANAGEMENT.....		1
	7-3.01	DISTRIBUTION AND ASSIGNMENT OF SURVEY EQUIPMENT	1
	7-3.02	TRANSFER, TRADE-IN OBSOLETE, JUNKED OR SURPLUS FIXED ASSET EQUIPMENT	1
	7-3.03	STOLEN, LOST OR DAMAGED EQUIPMENT	1
	7-3.04	INVENTORY	2

7-4 **EQUIPMENT AND MAINTENANCE**..... 2
 7-4.01 FIELD CARE AND ADJUSTMENTS..... 2
 7-4.02 SERVICING AND REPAIRS 2

CHAPTER 8 - SAFETY AND TRAFFIC CONTROL

8-1 **INTRODUCTION**..... 1
 8-2 **PERSONNEL**..... 1
 8-3 **TRANSPORTATION**..... 1
 8-4 **EQUIPMENT** 1
 8-5 **TRAFFIC**..... 1
 8-6 **MISCELLANEOUS**..... 1

APPENDICIES

A – 1 **INTRODUCTION**..... 1
 A – 2 **MINIMUM REQUIREMENTS** 1
 A – 2.01 INTRODUCTION 1
 A – 2.02 MN/DOT REQUIREMENTS 1
 A – 2.0201 Prime Contractor Requirements..... 1
 A – 2.0202 Surveyor Requirements..... 1
 A – 3 **WORKING RELATIONSHIPS**..... 1
 A – 3.01 INTRODUCTION 1
 A – 3.02 BETWEEN THE PRIME CONTRACTOR – SURVEYOR – INSPECTOR/ENGINEER..... 1
 A – 3.0201 Keeping the Relationship Professional..... 1
 A – 3.0202 Communications 1
 A – 3.0203 Staking Requirements 2
 A – 3.03 RELATIONS BETWEEN THE PRIME CONTRACTOR AND SURVEYOR..... 3
 A – 3.0301 Issues in Common..... 3
 A – 3.0302 Prime Contractor 3
 A – 3.0303 Surveyor 3
 A – 3.04 RELATIONS BETWEEN PRIME CONTRACTOR AND INSPECTOR/ ENGINEER 4
 A – 3.0401 Prime Contractor 4
 A – 3.0402 Inspector/Engineer 4
 A – 3.05 RELATIONS BETWEEN INSPECTOR/ENGINEER AND SURVEYOR 5
 A – 3.0501 Inspector/Engineer 5
 A – 3.0502 Surveyor 5
 A – 4 **MN/DOT SURVEY SUPPORT** 1
 A – 4.01 INTRODUCTION 1
 A – 4.02 MANUALS..... 1
 A – 4.03 SPECIFICATIONS..... 1
 A – 4.04 CONSTRUCTION PLAN..... 1
 A – 4.0401 Title Sheet..... 2
 A – 4.0402 Estimated Quantities 2
 A – 4.0403 Standard Plates 2
 A – 4.0404 Earthwork Tabulations..... 3
 A – 4.0405 Pay Item Tabulations..... 3
 A – 4.0406 Inplace Utility Plan and Tabulations 3
 A – 4.0407 Typical Sections..... 4
 A – 4.0408 Standard Plans 4
 A – 4.0409 Staging Plan 5

A – 4.0410	Horizontal Alignment	5
A – 4.0411	Inplace Topography.....	5
A – 4.0412	Construction Plan.....	6
A – 4.0413	Roadway Profiles (Vertical Alignment).....	6
A – 4.0414	Superelevation.....	6
A – 4.0415	Structures and Walls.....	7
A – 4.0416	Drainage Plan	7
A – 4.0417	Drainage Profile.....	7
A – 4.0418	Drainage Tabulations.....	7
A – 4.0419	Special Ditches.....	8
A – 4.0420	Traffic Control.....	8
A – 4.0421	Lighting Plan.....	8
A – 4.0422	Traffic Signal and Sign Plans.....	8
A – 4.0425	Bridge Plan.....	10
A – 4.0426	Standard Staking Sheets	11
A – 4.05	CONTROL.....	11
A – 4.0501	Horizontal Control	11
A – 4.06	RIGHT-OF-WAY	12
A – 4.07	ELECTRONIC FILES AND SUPPLEMENTAL SOFTWARE	12
A – 4.0701	Plan Data Files	12
A – 4.0702	Mn/DOT Developed Survey Applications.....	13
A – 4.08	SUMMARY	13
A – 5	SCOPE-OF-WORK.....	1
A – 5.01	INTRODUCTION	1
A – 5.02	SPECIFIED TASKS.....	1
A – 5.03	IMPLIED TASKS.....	1
A – 5.04	COMMON SENSE AND STANDARDS OF PRACTICE.....	2
A – 5.05	SUMMARY	2
A – 6	END OF PROJECT SUBMITTALS.....	2
S -	(2011) CONSTRUCTION SURVEYING.....	1
S – 1	GENERAL SURVEY SPECIFICATIONS.....	1
S – 2	SURVEYING TO BE PERFORMED BY MN/DOT.....	1
S – 3	CONSTRUCTION SURVEYING BY THE CONTRACTOR.....	2
S – 4	METHOD OF MEASUREMENT.....	5
S – 5	BASIS OF PAYMENT.....	5
APPENDIX B – PERTINENT MN/DOT POLICIES.....	1	
B – 1	MN/DOT “CERTIFICATE OF LOCATION OF GOVERNMENT CORNER” POLICY.....	1
B – 2	OBLITERATED PROPERTY MONUMENTS.....	1
B - 3	DEPARTMENT POLICY REGARDING TRUNK HIGHWAY RIGHT-OF-WAY.....	1

FOREWORD

The sophisticated surveying technology developed for the space programs opened the way to research and development on new surveying theory and practice.

In 1971 the Minnesota Highway Department, now the Department of Transportation, engaged Professor Jesse E. Fant from the Department of Civil Engineering at the University of Minnesota, to assist the Department in the development of a “Modern Surveying System.”

It was a unique and ambitious undertaking involving a parallel training and education program for 42 employees. The main goals were to implement major changes in surveying methods and standards; to conduct research in the use of modern surveying equipment; to develop automation techniques for department surveys; and to conduct an extensive training and education program for Central Office and District personnel.

The program centered around four broad areas: control surveys, land surveys, plat preparation and research projects. The end result provided: A common language and method of operation established among all surveying and mapping offices in the Department, a core of trained employees in each Department office to carry out these new methods, surveys which are highly accurate and reliable, and coordination of survey data into the process of Highway Design, Right of Way and Construction.

This manual incorporates and sets forth accepted practices developed in the Surveying Program and the Interactive Graphics/Automated Drafting System. The manual will be kept current through a continuing program to keep Surveying and Mapping personnel up-to-date on the changes coming about because of research, new technology and the surveying organization of Mn/DOT, while continuing to emphasize sound survey practices.

With deep appreciation the Mn/DOT staff acknowledges Jesse E. Fant and Mn/DOT District and Central Office personnel who have contributed to the development of a Modern Surveying System and to the contents of this Surveying and Mapping Manual.

PREFACE

The Surveying and Mapping Manual contains material that is informational and instructional, and that sets forth uniform guidelines and accepted practices to be used by Mn/DOT personnel performing Surveying and Mapping work.

The manual is primarily designed for use at the Transportation Specialist level and above, and to provide uniformity of application statewide.

While the manual was written for use by Mn/DOT personnel, other agencies may utilize the manual as deemed appropriate: however, Mn/DOT accepts no responsibility, legal or other, for the adequacy of the methods and procedures contained in this manual, when used outside of Mn/DOT.

Revisions and supplements to this manual will be periodically posted to the Mn/DOT website. All holders of the manual should check the Mn/DOT website to be sure they have the current version.

Users of the manual are invited to submit ideas for suggestions for change or improvements or errors to be corrected in specific chapters or portions thereof to the Assistant Director, Surveying and Mapping Section, Office of Land Management, 395 John Ireland Boulevard, St. Paul, Minnesota 55155.

CHAPTER 1 - GENERAL

1-1 INTRODUCTION

1-1.01 PURPOSE

1-1.02 SCOPE

1-2 SURVEYING AND MAPPING SECTION - OFFICE OF LAND MANAGEMENT

1-2.01 SURVEYING AND MAPPING SECTION FUNCTIONS

1-2.02 SURVEYING AND MAPPING SECTION ACTIVITIES

1-2.0201 Geodetic Unit

1-2.0202 Legal Descriptions and Commissioner's Orders Unit

1-2.0203 Platting Unit

1-2.0204 Land Information System and Right of Way Mapping Unit

1-2.0205 Survey Research and Support Unit

1-2.0206 Photogrammetric Unit

1-2.03 REQUESTS FOR SERVICES FROM THE SURVEYING AND MAPPING SECTION

1-3 DISTRICT SURVEYING AND MAPPING

1-3.01 DISTRICT SURVEYING AND MAPPING FUNCTIONS

1-3.02 DISTRICT SURVEYING AND MAPPING ACTIVITIES

1-3.03 WORK AUTHORITIES

1-4 SURVEYS GROUP ORGANIZATION

1-4.01 SURVEYS GROUP ADVISORY COMMITTEE

1-4.02 SURVEYS GROUP COMMITTEE STRUCTURE

1-4.0201 Equipment Committee

1-4.0202 Automation Committee

1-4.0203 Personnel and Training Committee

CHAPTER 1 - GENERAL

1-1 INTRODUCTION

1-1.01 PURPOSE

The Minnesota Department of Transportation (Mn/DOT) Surveying and Mapping Manual provides an overview of the surveying and mapping functions in the department. This manual contains material that is of both an informational and instructional nature. Guidelines and procedures are spelled out in detail in the hope that greater uniformity and quality can be obtained in surveying and mapping related activities within Mn/DOT.

The manual clarifies policies and procedures technical and professional surveying and mapping personnel use in their day to day work. Using these procedures should result in uniform surveying and mapping practices.

The manual introduces procedures to work with survey equipment now being used throughout Mn/DOT.

1-1.02 SCOPE

The manual is written for use at the Senior Highway Technician level or above.

The manual contains definitions of common surveying and mapping terms used to communicate with colleagues and clients.

The manual also references other Mn/DOT manuals and other references as necessary for understanding a topic.

1-2 SURVEYING AND MAPPING SECTION - OFFICE OF LAND MANAGEMENT**1-2.01 SURVEYING AND MAPPING SECTION FUNCTIONS**

Develop and implement surveying and mapping policies, procedures and training.

Test and research new surveying and mapping methods and equipment for Mn/DOT. Budget, purchase and integrate these new methods and equipment.

Represent Mn/DOT with governmental agencies and professional and private organizations.

Work with the District Survey Offices to provide training to surveying and mapping personnel in applications of geodetic surveys, Public Land Survey System (PLSS) and property surveys, legal descriptions, right of way platting, right of way mapping, and Land Information Systems (LIS).

Coordinate Mn/DOT surveying and mapping activities with each District Survey Engineer/Surveyor.

Provide surveying and mapping products and services as necessary for planning, design, construction and maintenance of the transportation system.

1-2.02 SURVEYING AND MAPPING SECTION ACTIVITIES*1-2.0201 Geodetic Unit*

The Geodetic Unit performs the following services:

- a. Second order geodetic control surveys to establish horizontal and vertical control monuments on transportation system projects.
- b. Schedule work, process data and maintain records for a monumented network of second order horizontal and vertical control, and photo control.
- c. Maintain the Geodetic Database.
- d. Coordinate with the National Geodetic Survey (NGS) to maintain standards and keep Minnesota tied into the national control network.

1-2.0202 Legal Descriptions and Commissioner's Orders Unit

The Legal Descriptions and Commissioner's Orders Unit performs the following services:

- a. Prepare Commissioner's Orders.
- b. Maintain copies of the Commissioner's Orders.
- c. Conduct training on preparation and writing of legal descriptions.
- d. Provide quality assurance on plat descriptions prepared by the Districts.
- e. Prepare narrative descriptions for R/W acquisition and disposal.

1-2.0203 Platting Unit

The Platting Unit provides the following services:

- a. Conduct training on the preparation of R/W plats.
- b. Provide quality assurance on plats prepared by the Districts.
- c. Maintain the “Mn/DOT Official Copy” of each plat
- d. Maintain copies of the “Certificate of Location of Government Corner” for each plat.

1-2.0204 Land Information System and Right of Way Mapping Unit

The LIS and R/W Mapping Unit provides the following services:

- a. Develop and maintain current and historical maps of Mn/DOT R/W
- b. Assist internal and external customers with R/W Map needs
- c. Develop LIS/GIS applications and training for the Office of Land Management

1-2.0205 Survey Research and Support Unit

The Survey Research and Support Unit provides the following services:

- a. Research and test surveying methods and equipment.
- b. Conduct training on survey methods and equipment.
- c. Operate the Mn/DOT Virtual Reference Station (VRS)/Continuously Operating Reference Station (CORS) system.
- d. Develop survey specific applications to enhance the effectiveness of Mn/DOT's Computer Aided Engineering Systems.

1-2.0206 Photogrammetric Unit

The Photogrammetric Unit, while not a part of the Surveying and Mapping Section, none-the-less works closely with surveying and mapping personnel throughout the Department. The Photogrammetric Unit performs the following services:

- a. Prepare consultant contracts for aerial photography, overload photogrammetric mapping and photographic laboratory services.
- b. Review and recommend aerial photography and mapping requests.
- c. Provide photogrammetric (planimetric, topographic and cross section) mapping and digital ortho photographs and mosaics.
- d. Maintain the library of aerial photography, quadrangle maps and statewide high altitude film positives.
- e. Sell Mn/DOT aerial photographs.

1-2.03 REQUESTS FOR SERVICES FROM THE SURVEYING AND MAPPING SECTION

In order to avoid duplication of work and effort on a project, requests for surveying and mapping services should be channeled through the appropriate District Survey Office. The District Survey Engineer/Land Surveyor is responsible for their survey records and should be knowledgeable about past and present respective district surveying and mapping activities.

1-3 DISTRICT SURVEYING AND MAPPING

1-3.01 DISTRICT SURVEYING AND MAPPING FUNCTIONS

The district surveying and mapping functions to collect field data, map, stake and document construction projects. It also maintains records of survey data, provides land surveying and cooperates with other governmental agencies and private land surveyors and engineers in the exchange of survey information.

1-3.02 DISTRICT SURVEYS AND MAPPING ACTIVITIES

Request aerial photography and/or mapping from the Surveying and Mapping Section.

Establish third order horizontal and vertical control networks.

Cooperate with Geodetic Unit in establishing second order horizontal and vertical control.

Recover existing roadway alignment and compute new alignment where necessary.

Collect complete location survey data on proposed construction projects.

Collect complete bridge survey and hydraulics data for proposed bridge projects.

Make field photo control survey as requested by Surveying and Mapping Section.

Prepare maps of surveying information.

Locate or reestablish land corners and file certificates on them. Cooperate with public and private land surveyors in locating, reestablishing, perpetuating and recording land corners.

Prepare and record right of way acquisition and monumentation plats.

Monument new and existing right of way.

Stake construction projects and record required final measurements according to established policy standards of Mn/DOT.

Maintain records of district survey data and maps.

Assist in the development of the district construction program.

Review final plan sheets to ensure that final alignments and land corners are placed and recorded.

Provide staff training, including those in Mn/DOT's rotation program for Land Surveyor In Training (LSIT).

Provide miscellaneous site surveys.

Review proposed platting and permits for work or developments on or adjacent to trunk highways.

1-3.03 WORK AUTHORITIES

Mn/DOT is required by law to maintain adequate cost accounting records. The Work Authority is the document for doing so. No work should be performed on any project prior to initiation, approval and processing of the Work Authority (Form 2116).

At times it may be necessary to use district overhead activities prior to issuance of a Work Authority in order to start initial survey work and prepare for preliminary mapping.

1-4 SURVEYS GROUP ORGANIZATION

The Surveys Group consists of engineers and surveyors from the Office of Land Management, Mn/DOT's National Geodetic Survey (NGS) Advisor, District Surveyors/Survey Engineers or Land Management Directors and survey resource information people.

1-4.01 SURVEYS GROUP ADVISORY COMMITTEE

The Surveys Group Advisory Committee is made up of the District Surveyor from each District as well as the Metro Survey Manager and the Assistant Director, Surveying and Mapping Section, OLM. The role of this committee is to:

- a. recommend strategy for handling issues;
- b. review and finalize standing committee recommendations for approval by the full Surveys Group; and
- c. communicate information to the Pre-Construction and Construction Manager Groups and Engineering Services Staff.

1-4.02 SURVEYS GROUP COMMITTEE STRUCTURE

The standing committees identify, review and study issues. They recommend and act as resource groups that report to the Survey Advisory Committee and the full Surveys Group. The three standing committees and their function are as follows.

1-4.0201 Equipment Committee

Ensure that the quality of the survey equipment meets the needs of the department for precision, reliability and durability. Promote the timely acquisition and equitable distribution of needed equipment.

1-4.0202 Automation Committee

Recommend automation equipment and software acquisition to the Surveys Group. Provide direction to the Office of Land Management Information Technology Unit in developing and maintaining automated systems for the districts and central office survey functions.

1-4.0203 Personnel and Training Committee

Advise Mn/DOT on future needs for surveying professionals and technicians and assist in determining job requirements. Develop, conduct and monitor training sessions required in the surveys area.

CHAPTER 2 - GEODETIC SURVEYS

- 2-1 INTRODUCTION**
 - 2-1.01 PURPOSE**
 - 2-1.02 CLASSIFICATIONS, STANDARDS, AND SPECIFICATIONS**
 - 2-1.0201 Primary Control (First and Second Order)**
 - 2-1.0202 Secondary Control (Third Order)**
 - 2-1.0203 Supplemental Control**
 - 2-1.03 GEODETIC CONTROL OPERATIONS IN MINNESOTA**
 - 2-1.0301 National Geodetic Survey (NGS)**
 - 2-1.0302 Mn/DOT Geodetic Unit**
 - 2-1.0303 U.S. Geological Survey (USGS)**
 - 2-1.04 INTERNAL RELATIONSHIPS**
 - 2-1.0401 Mn/DOT District Surveys**
 - 2-1.05 EXTERNAL RELATIONSHIPS**
 - 2-1.0501 National Geodetic Survey (NGS)**
 - 2-1.0502 U. S. Geological Survey (USGS)**
 - 2-1.0503 County Highway Engineers and County Land Surveyors**
 - 2-1.0504 Private Consultants**

- 2-2 GEODETIC PRODUCTS AND SERVICES**
 - 2-2.01 NATIONAL GEODETIC SURVEY (NGS)**
 - 2-2.0101 NGS Filing System**
 - 2-2.0102 NGS Information Center**
 - 2-2.0103 NGS Triangulation Diagrams**
 - 2-2.0104 Control Leveling Index (CLI) Maps**
 - 2-2.0105 NGS/USGS Geodetic Control Diagrams**
 - 2-2.02 U. S. GEOLOGICAL SURVEY (USGS)**
 - 2-2.0201 USGS Filing System**
 - 2-2.0202 USGS Quadrangle Maps**
 - 2-2.0203 USGS Digital Orthophotos**
 - 2-2.0204 USGS Horizontal Data Quads**
 - 2-2.0205 USGS Vertical Data Quads**

**2-2.03 MINNESOTA DEPARTMENT OF TRANSPORTATION
(Mn/DOT)****2-2.0301 Mn/DOT Geodetic Control Mark Index Maps****2-2.0302 Mn /DOT District Control Mark Index Maps****2-2.0303 Mn/DOT Geodetic Database****2-2.0304 Mn/DOT Horizontal Control Report****2-2.0305 Mn/DOT Vertical Control Report****2-2.0306 Mn/DOT Mark Maintenance Control Report****2-3 GEODETIC MONUMENTATION AND MARK PRESERVATION****2-3.01 HISTORY OF GEODETIC CONTROL MARKS****2-3.02 THREE DIMENSIONAL MONUMENTS****2-3.03 HARN MONUMENTATION****2-3.04 VERTICAL CONTROL MARKS – BENCH MARKS****2-3.0401 General Instructions for Setting Vertical Control
Marks****2-3.0402 Setting Precast Marks and Poured Concrete****2-3.0403 Setting Marks in Structures****2-3.0404 Setting Rod and Disk Marks****2-3.0405 Recovery of Vertical Control Marks****2-3.0406 Resetting Vertical Control Marks****2-3.0407 Report on Relocation of Bench Mark (NOAA 76-60)****2-3.05 HORIZONTAL CONTROL MONUMENTS****2-3.0501 General Instructions for Setting Horizontal Control
Marks****2-3.0502 Setting Poured Concrete Marks****2-3.0503 Setting Marks in Structures****2-3.0504 Recovery of Horizontal Control Marks****2-3.0505 Resetting Marks - Raising or Lowering a Station
In Place****2-3.0506 Relocating Marks - Moving a Station****2-3.0507 Project Report****2-3.06 DESCRIPTIONS OF GEODETIC CONTROL MARKS****2-3.0601 Description of Geodetic Control Marks****2-3.07 RECOVERY OF 3D CONTROL MARKS**

- 2-3.08 PRESERVING GEODETIC CONTROL MARKS**
 - 2-3.0801 Witnessing Marks**
 - 2-3.0802 Notification of Proposed Construction Plans and Pending Mark Destruction**
- 2-3.09 FUTURE OF GEODETIC MONUMENTATION**
 - 2-3.0901 Continuously Operating Reference Stations (CORS)**
 - 2-3.0902 Traditional Geodetic Marks**

- 2-4 HORIZONTAL CONTROL**
 - 2-4.01 GEODETIC DATUMS**
 - 2-4.02 COORDINATE SYSTEMS**
 - 2-4.0201 Geodetic Position (Latitude, Longitude)**
 - 2-4.0202 Universal Transverse Mercator Projection (UTM)**
 - 2-4.0203 Minnesota State Plane Coordinate System**
 - 2-4.0204 Project Coordinate System**
 - 2-4.0205 County Coordinate System**
 - 2-4.03 Mn/DOT PRIMARY HORIZONTAL CONTROL SURVEYS (NGS-PUBLISHED FIRST AND SECOND ORDER)**
 - 2-4.0301 Field Specifications and Records**
 - 2-4.0302 Office Data Processing**
 - 2-4.04 Mn/DOT SECONDARY HORIZONTAL CONTROL SURVEYS (THIRD ORDER)**
 - 2-4.0401 Field Specifications and Records**
 - 2-4.0402 Mn/DOT Least-Squares Horizontal Adjustment**
 - 2-4.05 SUPPLEMENTAL HORIZONTAL CONTROL SURVEYS**
 - 2-4.0501 Field Specifications and Records**

- 2-5 VERTICAL CONTROL**
 - 2-5.01 ELEVATION DATUMS**
 - 2-5.0101 National Geodetic Vertical Datum of 1929 (NGVD 29)**
 - 2-5.0102 North American Vertical Datum of 1988 (NAVD 88)**
 - 2-5.02 NETWORK DESCRIPTIONS**

**2-5.03 Mn/DOT PRIMARY VERTICAL CONTROL SURVEYS
(NGS-PUBLISHED)**

2-5.0301 Field Specifications and Records

2-5.0302 Collimation Constant, "C"

2-5.0303 Office Data Processing

2-5.04 Mn/DOT SECONDARY VERTICAL CONTROL SURVEYS

2-5.0401 Field Specifications and Records

2-5.0402 Reciprocal Leveling

2-5.05 SUPPLEMENTAL VERTICAL CONTROL SURVEYS

2-5.0501 Field Specifications and Records

2-5.06 FUTURE OF VERTICAL CONTROL

2-6 THE GLOBAL POSITIONING SYSTEM

2-6.01 INTRODUCTION

CHAPTER 2 - GEODETIC SURVEYS

2-1 INTRODUCTION

This chapter addresses the purpose, classes and uses of geodetic control, the procedures for procurement of control data, and the standards and methods for establishing and maintaining geodetic control.

Definitions of Geodetic and Surveying terms used in this chapter may be found in the American Congress on Surveying and Mapping Manual (ACSM) titled "Definitions of Surveying and Associated Terms," dated 1972. The following definitions of Geodesy and Geodetic Surveying are from that publication:

Geodesy: The science, which treats mathematically, of the figure and size of the earth. The term is often used to include both the science, which must depend on determinations of the figure and size of the earth from direct measurements made on its surface (triangulation, leveling, astronomic, and gravity determinations), and the art, which utilizes the scientific determinations in a practical way and is usually known as geodetic surveying or geodetic engineering.

Geodetic Surveying: That branch of the art of surveying in which account is taken of the figure and size of the earth. Also called geodetic engineering. In geodetic surveying, prescribed precision and accuracy of results are obtained through the use of special instruments and field methods, and equations based on the geometry of a mathematical figure approximating the earth in form and size.

2-1.01 PURPOSE

Federal, state and local governments make surveys, maps and charts of various kinds that are referenced to national horizontal and vertical datums. These datum ties are necessary to provide basic information for: planning and carrying out national, state and local projects; programs relating to the development and utilization of our natural resources; private development. Requirements for geodetic control are most critical in urban areas where intense development is taking place and land values are high.

Government agencies and the private sector cooperate in various aspects of surveying and mapping. In making surveys and maps of large or small land areas, it is first necessary to establish frameworks of horizontal and vertical control to provide a basis for all surveying and mapping operations and so insure a coherent product. This is an especially important first step in creating a Geographic or Land Information System (GIS/LIS).

Geodetic surveys of large areas are affected by, and must take into account, the curvature of the earth, location on the earth's surface, and elevation above sea level.

The terms "Geodetic Survey" and "Control Survey", as used synonymously in this text, are surveys executed to specified accuracies and standards and are used as a basis for mapping, charting, engineering and land utilization projects.

2-1.02 CLASSIFICATION, STANDARDS, AND SPECIFICATIONS

Geodetic control established and used by the Minnesota Department of Transportation (Mn/DOT) is classified as primary, secondary, and supplemental. The main factors affecting Mn/DOT classification of control monuments are: type of monument, standards and specifications followed in establishing the monument, methods of executing the survey, and procedures which lead to the acceptance for publication of coordinates and/or elevations of these monuments by the National Geodetic Survey (NGS).

2-1.0201 Primary Control (First and Second Order)

Primary geodetic control refers to permanently monumented and referenced horizontal and vertical control monuments whose coordinates or elevations are accepted for publication by the National Geodetic Survey (NGS). Horizontal control monument positions are given in latitude and longitude, Universal Transverse Mercator (UTM) coordinates, Minnesota State Plane coordinates, and Minnesota County coordinates. Vertical control monument elevations are given in elevation above mean sea level (height above the geoid) and in some cases, height above the ellipsoid. Primary control is established to first (1st) and second (2nd) order standards of accuracy and specifications as prescribed in the Federal Geodetic Control Committee's bulletins **Classifications, Standards of Accuracy and General Specification of Geodetic Control Surveys**, dated February 1974, and **Specifications to Support Classification, Standards of Accuracy and General Specifications of Geodetic Control Surveys**, dated 1980 or subsequent revisions thereof.

In 1985, the Mn/DOT Geodetic Unit began establishing primary horizontal control using the Global Positioning System (GPS). Specifications for performing horizontal control using GPS were first issued in 1985, and since that time there have been many revisions. These specifications and bulletins are available from the Mn/DOT Geodetic Unit or they can be ordered directly from the National Geodetic Information Center (see **Geodetic and Charting Publications** dated October, 1998).

First and second order geodetic control established by the Geodetic Unit of Mn/DOT are controlled by the above general standards and specifications and the procedures for field and office work as required by the NGS for adjustment and publication.

In October 1993, Mn/DOT began the initial GPS observations for the Minnesota High Accuracy Reference Network (HARN). HARNs are developed on a statewide basis in conjunction with the NGS program to institute a nationwide upgrade of the National Spatial Reference System (NSRS). These networks are designed to provide a statewide coverage of highly accurate control that meets or exceeds designated B-order standards of $8\text{mm} \pm 1:1,000,000$. The actual stations are spaced at intervals that make further densification convenient when using GPS equipment. Upon completion, a statewide readjustment of all existing horizontal control in the NSRS is performed to ensure network consistency.

HARN stations were established on a grid basis with a spacing of 25 km (± 4 km). If an existing horizontal or vertical control monument was available it was used; otherwise, a new monument was set. New monuments are deep driven rods set under a hinged cover to provide extra protection.

In January 2002, Mn/DOT began Federal Base Network (FBN) observations. The FBN provides spatial reference control that has some of the most precise accuracies available. FBN observations concluded in February 2002. This survey consisted of 54 stations on a 100 km grid spacing.

<http://www.ngs.noaa.gov/PROJECTS/FBN/>.

In January 2004, Mn/DOT began the Cooperative Base Network (CBN) observations. This survey consisted of 454 stations on a 25 km spacing. Phase 1 observations concluded in May 2004. These observations included stations in Districts 1 and 2. Phase 2 observations began in October 2004 and concluded in May 2005. These observations included stations in Districts 3,4,6,7,8 and Metro Division.

2-1.0202 *Secondary Control (Third Order)*

Secondary geodetic control refers to permanently monumented, non-published, horizontal and vertical control monuments that are established to lower standards, specifications and procedures than primary geodetic control. These control points are generally established by Mn/DOT District Surveys personnel or County and City Surveyors and Engineers to second or third order standards, specifications and procedures of the Federal Geodetic Control Committee's bulletins listed in Section 2-1.0201, and this manual's sections on horizontal and vertical control (Section 2-4.04 and Section 2-5.04).

Secondary control points are referenced, described and computed with the data permanently recorded and indexed in the files of the Geodetic Unit and the appropriate District Surveys Section or in County/City Surveyors or Engineers offices. The data is not submitted to the NGS for adjustment and publication.

2-1.0203 *Supplemental Control*

Supplemental control refers to non-permanent, non-published horizontal and vertical control points to provide horizontal and vertical control for mapping, engineering, land surveying and right of way projects. The standards, specifications, and procedures for establishing these points are lower than those for primary or secondary control.

Supplemental control points are generally temporary points (i.e., iron pins, hubs, spikes, or chisel marks) set by GPS, traverse or level lines. These surveys are initiated and closed on primary and secondary control points for proper ties to horizontal and vertical datums.

2-1.03 GEODETIC CONTROL OPERATIONS IN MINNESOTA

2-1.0301 *National Geodetic Survey (NGS)*

The majority of primary geodetic control in Minnesota was established prior to 1950 by the U.S. Coast & Geodetic Survey (now NGS). This control consists mainly of first order arcs of triangulation filled in with area nets of second order triangulation for horizontal control, and by loops of first order leveling along the major railroads with cross ties of second order leveling.

Since 1961, the NGS has been involved with the establishment of a network of high precision first order traverses and satellite triangulation stations to provide a basis for a new general adjustment of the national horizontal control network. The field work on two new precise traverses has been completed in Minnesota, and at least four permanent GPS base stations have been established in the state. Precise first order leveling operations by the NGS has been limited to re-leveling of some old first order lines.

In 1993, Mn/DOT and NGS completed High Accuracy Reference Network (HARN) measurements on twelve order AA (1:100,000,000) GPS Stations that are part of the Eastern Strain Network for North America. This was the first step in creating the constrained network for the HARN, a cooperative project between Mn/DOT and NGS.

2-1.0302 Mn/DOT Geodetic Unit

Mn/DOT's Geodetic Unit of the Surveying and Mapping Section is engaged in establishing primary geodetic control and in perpetuating existing primary control throughout the state. The Geodetic Unit is responsible for establishing horizontal and vertical geodetic control to the standards, specifications, and accuracy requirements of the NGS. Permanent monuments are provided in areas of planned transportation projects and tied to existing geodetic control for computation and adjustment into the published network of control by the NGS.

2-1.0303 U.S. Geological Survey (USGS)

In conjunction with their topographic mapping program, the U.S. Geological Survey establishes permanent second and third order horizontal and vertical geodetic control monuments as control for their mapping. The USGS adjusts and publishes their own control data as based on NGS control nets. The agency has no mark maintenance program for perpetuating geodetic control monuments after completion of the projects.

2-1.04 INTERNAL RELATIONSHIPS*2-1.0401 Mn/DOT District Surveys*

The Geodetic Unit works with District Surveys Sections as its primary customer in:

- a. Providing primary geodetic control surveys for their use in tying projects to the National Spatial Reference System (NSRS).
- b. Providing assistance for photogrammetric ground control when the District Surveys Section is not available.
- c. Providing technical assistance and advice in the maintenance work involved in recovery, resetting or relocating geodetic control marks.
- d. Testing and evaluation of methods, standards and equipment for determination of those best serving Mn/DOT survey needs and specifications.
- e. Providing access to the Geodetic Database and the automated Control Mark Index Maps.

District survey sections are involved in providing assistance of personnel and equipment to the Geodetic Unit when necessary to accomplish the scheduled geodetic work in that district.

2-1.05 EXTERNAL RELATIONSHIPS*2-1.0501 National Geodetic Survey (NGS)*

The Geodetic Unit works with the NGS in:

- a. Production of geodetic control to the standards and specifications of the NGS, submitted to and acceptable by the NGS for adjustment and publication.
- b. Perpetuation and maintenance of all primary geodetic control marks by Mn/DOT acceptable to NGS.
- c. The National Geodetic Survey's State Advisor Program.
- d. Establishment and the adjustment of the Minnesota High Accuracy Reference Network.
- e. Establishment and the adjustment of the Federal Base Network
- f. Establishment and the adjustment of the Cooperative Base Network.
- g. Adjustment of Height Modernization Data for GEOID model improvement.

The National Geodetic Survey provides published horizontal and vertical control data, control indexes and diagrams to the Mn/DOT Geodetic Unit and to other public agencies.

2-1.0502 U.S. Geological Survey (USGS)

The Geodetic Unit works with the USGS in:

- a. Perpetuating USGS geodetic control marks and providing data on their monuments to other government agencies and private surveyors and engineers.
- b. Providing the USGS with horizontal and vertical control data on primary and secondary geodetic control marks in areas of current USGS quadrangle mapping activity, or digital orthophoto quad production.

The USGS provides copies of all their published and preliminary control data, control indexes and quadrangle maps to the Mn/DOT Surveying and Mapping Section.

2-1.0503 County Highway Engineers and County Land Surveyors

The Geodetic Unit works with the County Engineers and County Land Surveyors by furnishing upon request:

- a. Copies of published and preliminary primary and secondary geodetic control data and related available survey data.
- b. Technical office and field assistance through the Highway State Aid Technical Engineering Assistance Program, partnerships, and county densification projects.

The County Highway Engineers and County Land Surveyors assist Mn/DOT with the establishment, preservation and maintenance of geodetic control monuments. They report on the condition of marks in place, those destroyed or subject to destruction, and provide information on new geodetic control monuments established by the county.

2-1.0504 Private Consultants

The Geodetic Unit provides published or preliminary geodetic control data upon request. The private consultant assists in the preservation and maintenance of geodetic control marks by reporting on the condition and possible destruction of geodetic control marks.

The Geodetic Unit through the pre-qualification program administers contracts in four levels of Geodetic Surveying. Level 1 consists of project setup, reconnaissance and monumentation of Geodetic Control Projects. Level 2 consists of First-Order Horizontal control field work. Level 3 consists of Second- Order Class I Vertical control field surveys. Level 4 consists of processing of raw field data and submission of final report to NGS, District and the Geodetic Unit.

<http://www.dot.state.mn.us/consult/files/prequal/prequal.html>

2-2 GEODETIC PRODUCTS AND SERVICES

The purpose of this section is to describe the major control data products and services available that the Mn/DOT Geodetic Unit and Mn/DOT District Survey Sections use or generate in their activities. Items concerned mainly with the Land Surveys, Photogrammetry, and Engineering Surveys Sections of this manual are generally not included here.

The Mn/DOT Geodetic Unit has NGS, USGS, Mn/DOT permanent geodetic control and county data for the entire state. Mn/DOT District Survey Sections have this same data, as well as information on non-permanent control points.

To develop a reference file of geodetic control information, the following products are recommended:

- a. USGS Quadrangle Maps (Section 2-2.0203).
- b. Mn/DOT Geodetic Control Mark Index Maps (Section 2-2.0302).
- c. Mn/DOT Geodetic Database (computer disks, direct computer access and website).
- d. NGS Geodetic Database-CD ROM.
- e. Mn/DOT Horizontal and Vertical Control Reports in PDF format in the Electronic Document Management System (EDMS).

2-2.01 NATIONAL GEODETIC SURVEY (NGS)

The National Geodetic Survey, formerly called the U.S. Coast and Geodetic Survey, is the primary source of precise geodetic control in the U.S. It is the primary agency that has established 1st order control, and it is in charge of adjusting non-NGS surveys into the national networks. The Mn/DOT Geodetic Unit performs 1st and 2nd order control surveys in according to specifications established by the NGS. Specifications that determine "order" include precision and procedures. The non-NGS surveys are submitted to the NGS for final adjustment and publication by the NGS as horizontal or vertical control data.

2-2.0101 NGS Filing System

NGS 30-MINUTE QUADRANGLE: This is the basis of the NGS filing system. Each quadrangle contains an area bounded by 30 minutes of latitude and 30 minutes of longitude, where each boundary is a multiple of 30 minutes of latitude or longitude. The area circumscribed by 45 and 46 degrees latitude, and 93 and 94 degrees longitude therefore contains four complete NGS 30-minute quadrangles. Beginning in the northeasterly of these four and proceeding clockwise, the NGS 30-minute quadrangle designations for these four quadrangles are 450931, 450932, 450933, and 450934. These designations correspond to the NE, SE, SW, and NW quadrants of the 1 degree latitude by 1 degree longitude area where the limits of the 1 square degree area are always integer values of degrees. NOTE: The numbers 46 and 94, which are the upper limits for latitude and longitude in the 1 square degree area, do not appear in the four NGS quadrangle numbers. In the northern hemisphere, latitude increases to the north. In the United States, longitude increases to the west. In Minnesota, the third character of the NGS quadrangle is always 0 (zero) because the longitude is always less than 100 degrees west.

Digit(s) Explanation:

1st & 2nd	Lower (southerly) latitude limit of 1 square degree area. Ranges from 42 through 49 in MN.
3rd	0 (zero) always in MN.
4th & 5th	Lower (easterly) longitude limit of 1 square degree area. Ranges from 89 through 97 in MN.
6th	30-minute by 30-minute quadrantal area of 1 square degree area. 1 (NE), 2 (SE), 3 (SW), or 4 (NW) always.

NGS LINES: Originally, the NGS indexed all of its vertical control data sheets involving Minnesota on the basis of a Minnesota "Line" number. Most of the State is still indexed by this method. A state's "line" number has no correlation to geographic location other than by definition of the route (line) followed during tile leveling; eg, "MN No. 68, Minneapolis, MN to Glasgow, MO." Some of the lines are very long and include other states. As of January 1976, 145 Published MN Line Numbers had been assigned by the NGS to leveling in Minnesota. Use of the Mn/DOT Geodetic Control Mark Index Maps allows one to determine the NGS-assigned MN Line Number for any vertical control marks indexed by this method. With reference to the Index portion of the Mn/DOT Geodetic Control Mark Index Maps, NGS-assigned MN Line Numbers are prefixed with "L" or "LINE". Most preliminary adjustment numbers are five digits, and they have an "L" in the database.

In the early 1980s, the NGS replaced this state line number indexing system with a quadrangle-line index system, in which each level line within a particular NGS 30-minute quadrangle is assigned a line number (unique to that quadrangle only), beginning with 101. An example of the NGS quadrangle-line vertical indexing system is 430961-104, which refers to the fourth level line assigned a line number (104) within NGS quadrangle 430961. Portions of western and northern Minnesota have been converted to the NGS quadrangle-line vertical indexing system.

2-2.0102 NGS Information Center

The NGS maintains an Information Center at their headquarters in Silver Spring, Maryland. The Center may be contacted by phone at (301) 713-3242, or by FAX at (301) 713-4172. In addition to processing single requests for horizontal and vertical control, the information center also supplies automated geodetic control information for large regions of the country on CD ROM. The CDs may be purchased through the Information Center.

The mailing address is:

National Geodetic Survey Division
N/CG 174
National Geodetic Information Center
1315 East-West Highway
Silver Spring, MD 20910-3282

THE CENTER ALSO MAINTAINS A WORLD WIDE WEB SITE:

http://www.ngs.noaa.gov/products_services.html

2-2.0103 NGS Triangulation Diagrams

The NGS triangulation diagrams that cover the State of Minnesota are useful when planning a horizontal control survey and when visualizing the relationships between the displayed horizontal control marks. The locations of most of the NGS published horizontal control marks, which include those of many different agencies and their relative survey networks, are superimposed over a background map of the State's counties, municipalities, railroads, lakes, and rivers. Additionally, these maps show one-degree intervals of latitude and longitude and 100,000 foot increments of the three MN State Plane Coordinate systems.

2-2.0104 Control Leveling Index (CLI) Maps

The two NGS control leveling index maps that cover the State of Minnesota may be useful when planning a vertical control survey. They show some of the NGS-published first and second order leveling lines that criss-cross the State; however, because of the density of monumentation, individual vertical control marks (bench marks) are not shown. Other aspects of these maps (Northern and Southern) are the same as those mentioned for the NGS triangulation diagrams in Section 2-2.0103. No elevations are given on the maps.

These index maps are obtainable from the NGS. It should be noted that the index maps have not been updated since 1971.

2-2.0105 NGS/USGS Geodetic Control Diagrams

The geodetic control diagrams show the location of horizontal and vertical control, as published by both the NGS and the USGS, in areas banded by even multiples of one degree of latitude and two degrees of longitude. Only the NGS-published horizontal control stations are individually named due to their wide dispersion.

The scale of these maps is 1:250,000 or about 1 inch = 4 miles, and their size is about 24 inches N/S by 28 inches E/W. Background data on these diagrams include municipalities, lakes, rivers, roads, railroads, and county boundaries.

Geodetic position (latitude and longitude) and State Plane Coordinate grid ticks are given, along with the Public Land Survey township and range data. The NGS 30-minute quadrangles and the USGS 15-minute quadrangles are both delineated and identified - there being 8 and 32 of these respectively on each geodetic control diagram.

The diagram number and name should both be used to identify each geodetic control diagram requested. The diagrams have not been updated since the 1960s.

2-2.02 U.S. GEOLOGICAL SURVEY (USGS)

The U.S. Geological Survey has placed extensive secondary (3rd order) horizontal and vertical control in Minnesota primarily to establish control for their mapping operations. The excellent series of 7½-minute quadrangle maps is one end-product of their efforts. They have also established some primary (2nd order) geodetic control monuments in the State.

The goals of the USGS and NGS are not the same. The USGS is concerned mainly with producing quality maps, while the NGS is concerned mainly with establishing primary (first and second order) geodetic control. Procedures followed by the USGS differ from the NGS when establishing geodetic control, since expensive 1st order control is not required for USGS mapping.

Section 2-2.02 discusses what Mn/DOT considers the main USGS documents available on geodetic control and gives the procedures to obtain them.

2-2.0201 USGS Filing System

The basis of the USGS filing system is the 15-minute quadrangle. Each quadrangle contains an area bounded by 15 minutes of latitude as one dimension and 15 minutes of longitude as the other. These boundaries are in multiples of 15 minutes of latitude and longitude. Therefore, each NGS 30-minute quadrangle (Section 2-2.0101) contains four complete USGS 15-minute quadrangles.

For further information, see “MINNESOTA Index to Topographical and Other MAP COVERAGE” published by the USGS.

2-2.0202 USGS Quadrangle Maps

The USGS quadrangle maps have many potential uses because of the information displayed upon them. In part, this information includes: ground elevation contours and sometimes water depth contours; spot elevations; latitude/longitude; MN State Plane Coordinates; Universal Transverse Mercator coordinate grids; Public Land Survey data; cultural and topographic features; magnetic declination; and locations of some geodetic control monuments.

Two series of quadrangle maps exist in Minnesota - the 7½-minute series and the 15-minute series. The former is at a scale of 1:24000 (1 inch = 0.38 miles), and each of these maps is about 27 inches N/S by 22 inches E/W. The corresponding values for the latter are 1:62500 (1 inch = 1 mile) and 21 inches N/S by 17 inches E/W. The 7½-minute series is more detailed and gets its name from its latitudinal and longitudinal limits, which are multiples of 7½- minutes. The 15-minute series is similarly named.

In 1996, the USGS began distribution of their quadrangle maps in an automated format called Digital Raster Graphics (DRG). A DRG is a scanned image of a USGS topographic map. The scanned color image includes all map margin information and the image inside the map neatline is georeferenced to the surface of the earth. The DRG can be used to collect, review, and revise other digital data, especially digital line graphics (DLG). When the DRG is combined with other digital products, such as digital orthophoto quadrangles (DOQ) or digital elevation models (DEM), the resulting image provides additional visual information for the extraction and revision of base cartographic information. The USGS plans to produce DRGs of the 1:24000-, 1:24000/1:25000-1:63360-(Alaska), and 1:100000-scale topographic map series beginning with the 1:24000-scale 7½-minute quadrangles.

The horizontal positional accuracy of the DRG matches the accuracy of the published source map; therefore, the 7½-minute DRG complies with National Map Accuracy Standard for the 7½-minute topographic map. To be consistent with other USGS digital data, the image is cast on the UTM projection and will therefore not always be consistent with the credit note on the image margin. Only the area inside the map neatline is georeferenced, so minor distortion of the text may occur in the map margin.

The DRG is useful as a backdrop onto which other digital data can be overlaid. The DRG can help assess the completeness of digital data from other mapping agencies and produce “hybrid” products.

For information contact:

Rolla-ESIC
U.S. Geological Survey
1400 Independence Rd., MS 231
Rolla, MO 65401-2602
314-341-0851; Fax 314-341-9375
<http://mcmcweb.er.usgs.gov/>

Additional information and sample images can be obtained through the World Wide Web at: <http://mapping.usgs.gov/>

2-2.0203 *USGS Digital Orthophotos*

A digital orthophoto is a digital image of an aerial photograph in which displacements caused by the camera and the terrain have been removed. It combines the image characteristics of a photograph with the geometric qualities of map.

The standard digital orthophoto produced by the U.S. Geological Survey is a black and white, color, or color-infrared, 1-meter ground resolution quarter-quadrangle image covering 3.75 minutes of latitude by 3.75 minutes of longitude at a scale of 1:12000. This image is called a digital orthophoto quadrangle (DOQ). DOQs are cast on the Universal Transverse Mercator projection, based on the North American Datum of 1983. They also have between 50 and 300 meters of over edge image beyond the primary and secondary datum corner tick extremes to facilitate tonal matching for creating mosaics with adjacent images.

The accuracy and quality of USGS digital orthophotos must meet National Map Accuracy Standards at 1:12000 scale for 3.75-minute quadrangles. Accuracy and quality are dependent on the following:

- a. Photographs that meet National Aerial Photography Program standards quarter-quadrangle centered (3.75 by 3.75 minutes in extent), exposed at a flying height of 20,000 feet above ground and with a 6-inch focal-length camera.
- b. A DEM with the same area coverage as the digital orthophoto that is equal to or better than a level-1 DEM with a root-mean-square error no greater than 7 meters.
- c. A highly accurate image scanning process that employs a scanning resolution between 7.5 and 32 microns (a 1:40000-scale image scanned at 25 microns produces a pixel ground resolution of 1 meter).
- d. A photo identifiable image and coordinates of ground control positions acquired from ground surveys or aerotriangulation.

A digital orthophoto can be used for a variety of applications. As a layer in a GIS, it can be used for revising digital vector files and topographic and planimetric maps. Other applications include vegetation and timber management, routing and habitat analysis, environmental impact assessments, emergency evacuation planning, flood analysis, soil erosion assessment, facility management, and groundwater and watershed analysis.

For more information on digital orthophotos, contact any Earth Science Information Center or call 1-800 USA-MAPS.

2-2.0204 *USGS Horizontal Data Quads*

The USGS horizontal data quads as used here are those USGS 15-minute quadrangle publications that are usually, if not always, with reference to the “North American Datum of 1927” as stated in the upper-left corner of the publication's header (front) sheet. These publications list MN State Plane Coordinates and geodetic positions for many cultural features, such as road intersections, and for some vertical control marks.

Since the state plane coordinates are usually published to an accuracy of only the nearest foot, versus the nearest hundredth of a foot for NGS positions, one must always consider if such accuracies are adequate for the intended use.

2-2.0205 *USGS Vertical Data Quads*

The USGS vertical data quads as used here are those USGS 15-minute quadrangle publications that are usually, if not always, referenced the “Sea Level Datum of 1929” as stated in the upper-left corner of the publication's header (front) sheet. These publications consist of multiple sheets, each of which contains the descriptions of many vertical control marks and their corresponding elevations to the nearest hundredth of a foot. Useful elevations (UEs) to the same accuracy are also given for many nongeodetic vertical control marks, such as a spike in a power pole. Each mark is referenced by mileage along the leveling line, and a header sheet relates the various lines to a map of the quadrangle that shows the location of the lines in relation to the limits of the quadrangle. USGS numbers within each USGS 15-minute quadrangle begin at 1.

2-2.03 MINNESOTA DEPARTMENT OF TRANSPORTATION (MN/DOT)

The Mn/DOT Geodetic Unit maintains automated geodetic control data for the entire state. Each Mn/DOT District Survey Section has direct access to this information through an Office of Land Management Internal Web Site <http://dot-lm/>

External customers have access to Geodetic information through an Office of Land Management External Web site <http://www.olmweb.dot.state.mn.us/geod/geoindex.htm>

Nearly all published geodetic control data in Minnesota comes from the NGS, USGS, and Mn/DOT. County surveyors and engineers have also become active in Minnesota in establishing geodetic control, consisting of both primary and secondary (supplemental) control marks. The Mn/DOT District Survey Sections also have unpublished information on non-geodetic supplemental control marks, such as spikes and iron pins.

The Mn/DOT Geodetic Unit establishes primary (1st and 2nd order) horizontal and vertical control. The field data is submitted, along with Mn/DOT preliminary adjustments, to the NGS for their final adjustment into the national geodetic control networks. This information is eventually published by the NGS as geodetic control data. As of May 12, 2007, there are nearly 51,109 control marks in the Mn/DOT Geodetic Database. Increased uses of GPS for positioning survey monuments or objects needing a coordinate and elevation reference for facility management in a GIS/LIS environment have generated more requests for geodetic control information. Requests for Mn/DOT data are recommended to be made initially to the Mn/DOT District Survey Sections.

2-2.0301 *Mn/DOT Geodetic Control Mark Index Maps*

These maps show the location of all horizontal and vertical geodetic control marks that exist within a particular county or fraction thereof. Geodetic control marks are, by definition, uniquely identifiable marks fastened to a relatively permanent base supporting structure. Geodetic control marks are usually 83 mm (3.25) diameter stamped disks fastened to a relatively stable support such as a concrete post, bridge, building, or rods driven to refusal. Non-geodetic control marks, eg. spikes in trees or poles, "X"s in concrete, iron pins, etc., and marks for which no recorded descriptions are known are not shown.

The location of each geodetic control mark is plotted by ArcMap using the Universal Transverse Mercator (UTM-Zone 15) Coordinate Metric System with background layers from the state basemap. Each unique, colored symbol denotes the type of control (HARN, 3-D, horizontal, vertical, & un-positioned). Symbols are colored shapes with the same colored leaders pointing to their labels. Using the labels, the accompanying map index sheet will identify the mark & give some additional data. More detailed information can be found in a .pdf report called datasheet or in the Mn/DOT Geodetic Database.

Each of the geodetic control mark is identified with a label that is its unique Geodetic Identification number in the Oracle database. The file reference states where the detailed information for the mark (description and/or elevation and/or horizontal position) can be found using the labels. The Mn/DOT Geodetic Unit has this information for nearly all geodetic control marks in Minnesota. (Figures 2-2.0301A and Figure 2-2.0301B).

The Mn/DOT Geodetic Control County Map, Index, & Data sheets may be requested from the Mn/DOT Geodetic Unit, and are also available as .pdf files through the office of Land Management External Web site <http://www.olmweb.dot.state.mn.us/geodetic/home.html>

2-2.0302 *Mn/DOT District Control Mark Index Maps*

These maps exist in some Mn/DOT District Survey Sections, and they usually show the location of all horizontal and vertical control marks (geodetic primary, secondary and supplemental). Different map bases are used usually at a scale larger than General County Highway Maps because of the increased number of control marks plotted on them. Methods of cross-referencing symbols, code numbers, names and file references exist within each pertinent Mn/DOT District Survey Section. Usually these survey sections are the only places that the descriptions, coordinates and elevations of the supplemental control marks can be obtained. These maps may be requested from the appropriate Mn/DOT District Survey Section.

2-2.0303 *Mn/DOT Geodetic Database*

INTRODUCTION

Mn/DOT maintains a Geodetic Database containing information on permanent geodetic control marks located in Minnesota or just outside its boundaries.

The marks have been established by all levels of government in Minnesota and they are referenced to the National Spatial Reference System (NSRS) (NAD 27, NAD 83, NGVD 29, and NAVD 88).

For information pertaining to the Mn/DOT Geodetic Database, contact:

Mn/DOT Geodetic Unit
Mailstop 641, Transportation Building
395 John Ireland Boulevard
St. Paul, MN 55155-1899
Tel: 651/366-3420
Fax: 651/366-3444

or visit the following website: <http://www.olmweb.dot.state.mn.us>

2-2.0304 Mn/DOT Horizontal Control Report

Detailed project reports for all of the Mn/DOT Geodetic Unit's primary (1st and 2nd order) horizontal control surveys are kept by the Unit. Reports contain copies of information sent to the NGS for their final adjustment and publication. These project reports contain preliminary positions, established by Mn/DOT, which are used prior to the publication of the final positions, as determined by the NGS. The pertinent Mn/DOT District Survey Sections have copies of the data essential for their use.

Beginning in 1985, County Surveyors and Engineers have also become active in Minnesota in establishing geodetic control, consisting of both primary and secondary (supplemental) control marks.

2-2.0305 Mn/DOT Vertical Control Report

Detailed project reports for all of the Mn/DOT Geodetic Unit's primary (2nd order) vertical control surveys are kept by the Unit. Reports contain copies of information sent to the NGS for their final adjustment and publication. These reports contain preliminary elevations, established by Mn/DOT, which are used prior to the publication of the final elevations, as determined by the NGS. The pertinent Mn/DOT District Survey Sections have copies of the data essential for their use.

2-2.0306 Mn/DOT Mark Maintenance Report

Mark maintenance is performed on NGS published marks. Any Mn/DOT mark maintenance activities are eventually reflected in records maintained by both NGS and Mn/DOT. One exception to this is the activity associated with secondary (3rd order) bench marks which are maintained by Mn/DOT only.

2-3 GEODETIC MONUMENTATION AND MARK PRESERVATION

“Positions and monuments are the two distinct yet inseparable products of geodetic surveying. The importance of permanent, locatable, stable monuments is unquestionable” (**NGS Operations Handbook**). This section will discuss the history, installation, description writing, preservation, and future of geodetic monumentation in Minnesota.

2-3.01 HISTORY OF GEODETIC CONTROL MARKS

The first geodetic control mark established in Minnesota was set by the United States Lake Service (USLS) in 1869. Since then, other federal agencies such as the Mississippi River Commission (MRC), the U.S. Coast and Geodetic Survey (USC&GS), the U.S. Geological Survey (USGS), the National Geodetic Survey (NGS), and numerous Minnesota Counties also installed geodetic control monuments. The Mn/DOT Photogrammetric Section’s Mobile Ground Survey Control Unit (later the Geodetic Unit) set its first control mark in 1961. From 1961 to 1975, Mn/DOT mainly used poured concrete monuments with a variety of different disks (Figure 2-3.01). They continued to use concrete monuments for horizontal control until 1981. Copper coated rods were used only for vertical control from 1975 to 1981. Since 1981, aluminum rods have been used for all control marks except for new HARN stations, which are made of stainless steel rods.

In 1993, the Geodetic Unit chose to use a dual-purpose 3-D monument (Section 2-3.02) for both horizontal and vertical applications. Between 1993 and 1995, 457 High Accuracy Reference Network (HARN) control stations were established. For a detailed description of older monumentation the reader should refer to the **MN/DOT Surveying and Mapping Manual** (2006) or the **National Geodetic Survey Operations Handbook** (1991).

2-3.02 THREE DIMENSIONAL MONUMENTS

With the increased usage of GPS, the Geodetic Unit began to install a new geodetic disk in 1993. The disk has no reference as to its horizontal or vertical function because eventually the monument will be positioned both ways. The location of the monument should have no overhead obstruction or any nearby obstacles that would make it difficult to set on with GPS equipment or to level through it. For more detailed site location instructions, refer to the reconnaissance phase of horizontal control surveys in Section 2-4.0301 or vertical control surveys in Section 2-5.0301 in this manual.

Rod Type Marks

The construction of a rod type monument (Figure 2-3.02B) consists of the following steps:

- a. At the selected site, glue the two bearings on each end of the 1 m (3 ft) plastic stabilizer section. Enough plastic stabilizers should be glued together at least 15 minutes ahead to insure a good bonding of the glue on the pipe.
- b. At the selected site, dig or auger a 15 cm (6 in) hole to a depth of 45 cm (1.5 ft) to accommodate a 15 cm (6 in) PVC pipe. Drill or dig a 5 cm (2 in) x 1 m (3 ft) hole to accommodate the stabilizer section.
- c. Attach a ground point to the first 1.5 m (5 ft) section of a 19 mm (0.75 in) aluminum rod. Slip the plastic stabilizer over the rod. Place the rod in the hole and place a wood plank (2” x 4”) that has two metal shafts projecting 13 cm (5 in), and a center hole diameter of 2.5 cm (1 in) over the rod to center the rod in the hole during the monumentation.

- d. Drive the rod into the hole with a motor drill such as a Pionjar or Cobra. Always attach a stainless steel driver on top of the aluminum rod that is being driven into the ground. Drive rods to absolute refusal or until the rod is moving at a rate of only 30 cm (1 ft) per minute. If an extraordinary amount of rod is being consumed, e.g., 24 m (80 ft) at a site, stop and resume the next day. Hopefully the surrounding soil will have compacted preventing further excessive usage of rods.
- e. Continue to attach additional sections of rod and drive them into the ground, while applying pressure with pipe wrenches to insure a good connection. If needed, cut the rod off at the desired height.
- f. Stamp the disk according to the correct naming convention (Sections 2-4.0301 and Section 2-5.0301) and then pound the disk on the top of the rod.
- g. Insert the 15 cm (6 in) PVC pipe into the hole so it is flush with the surface of the ground.
- h. Fill the inside of the pipe with fine sand or pea rock no more than 15 cm (6 in) from the disk. This is to help prevent frost action from moving the disk or popping it off altogether.
- i. Pour a ring of concrete around the outside of the PVC pipe. In certain areas, such as maintained lawns or areas subject to monument damage by vehicles, an access cover (Figure 2-3.02B) should be cemented over the top of the PVC pipe at or slightly below ground level.
- j. Install nearby a witness post nearby and attach using a newly designed pink survey marker witness sign (Figure 2-3.0401).

Stem Type 3-D Marks

Stem type monuments have historically been used mainly for vertical control (bench marks) and were placed in various stable structures (Section 2-3.0403). To be used as a 3-D monument, it is imperative that this type of disk is placed where a tripod can be set over the monument with a clear overhead view. The most common use of stem type monuments is in new bridge construction. The construction plan usually calls for its placement somewhere in the southeast corner. Unfortunately that is occasionally in the top of the rail making it impossible to set a tripod over or even too high or dangerous to set a level rod on. It is also imperative the disk is set outside of the expansion plates of bridges to prevent movement.

The following criteria refers to installing stem type 3-D monuments in existing structures:

- a. At the selected site, using a 2.5 cm (1 in) bit, drill a hole 76 mm (3 in) in length.
- b. Using a 102 mm (4 in) diameter reaming bit, drill a 6 mm (0.25 in) deep recess which will help prevent future vandalism of the disk.
- c. Stamp the disk according to the correct naming convention and epoxy the disk in the hole.

2-3.03 HARN MONUMENTATION

Between 1994 and 1995, the Geodetic Unit established a HARN monumentation grid according to NGS criteria. The following three topics are guidelines from the NGS for establishing Federal Base Network (FBN) stations, which are basically HARN stations spaced on average 100 km apart.

Selection Priorities

Station selection shall be based on the following priorities, which are given in order with the highest priority first. Within each priority category, preference should be given to selection of older monuments having a known history of measurements. FBN stations should be selected using:

- a. An existing A and B order station, where possible.
- b. A new station at a controlled airport. Where necessary, an additional nearby station, which is easily accessible by the public, will be established and directly connected to the airport station.
- c. An existing National Spatial Reference System (NSRS) station with a first or second order elevation and first or second order horizontal coordinates, with higher accuracy classification being preferred both vertically and horizontally (giving vertical accuracy top priority).
- d. An existing NSRS station with first or second order elevation, again the higher accuracy classification being preferred.
- e. An existing NSRS station with first or second order horizontal coordinates which would require a minimum amount of first or second order leveling (within 10 km) to establish a precise elevation.
- f. A new station or existing station not in NSRS yet suitable for GPS observations, set in bedrock, requiring a minimum amount of first or second order leveling (within 10 km) to establish a precise elevation.
- g. A new station or existing station not in NSRS yet suitable for GPS observations, established by setting a 3D monument, which would require a minimum amount of first or second order leveling (within 10 km) to establish a precise elevation.

Monumentation and Station Environment

The following is a list of considerations for every monument in the FBN. The intent is to insure that station monuments will be stable and remain usable for a long time.

- a. Adequate GPS satellite visibility (unrestricted at 15 degrees above the horizon). Minor obstructions may be acceptable but must be depicted on the Visibility Obstruction Diagram.
- b. Accessible by two-wheel drive passenger car or light truck (preferred).
- c. Stability, with bedrock mark being most preferred (See Stability).
- d. Permanency.
- e. Ease of recovery.
- f. Minimal multi-path sources.
- g. Appropriate geographic location and spacing.

- h. Location allows efficient use by surveying community.
- i. Accessible by public (See Accessibility).
- j. No known potential conflict with future development.
- k. Aerial-photo identifiable.
- l. Free of electronic interference.

Stability

Mark stability is difficult to assess in the field with limited resources. For existing NSRS station monumentation, the NGS database contains stability qualifiers that were assigned for the majority of marks when they were set. Existing NSRS stations must have a stability quality code of C or better. Quality codes A and B are preferred. New monuments will have a stability quality code of B or better.

There is a quality code C exception. When selecting FBN stations, only quality codes A and B are recommended. However, concrete monument may be selected with a C stability if the mark is deemed stable from review of historical releveling, soil type, and frost depth. Final selection is subjective, and it is based on local knowledge of soil and frost heave, plus knowledge of how well the mark has held its horizontal and vertical position over the years.

Quality codes are as follows:

Quality Code A = most reliable which are expected to hold an elevation. Examples: Rock outcrops; rock ledges; rock cuts; bedrock; massive structures with deep foundation; large structures with foundations on bedrock; or sleeved pipe or galvanized steel, stainless steel, or aluminum rods.

Quality Code B = probably hold an elevation. Examples: Unsleeved deep settings (3 m (10 ft) or more) with galvanized steel pipe or galvanized steel, stainless steel or aluminum rods; massive structures other than those listed under code A; massive retaining walls; abutments and piers of large bridges or tunnels; unspecified rods or pipe in a sleeve less than 3 m (10 ft); or sleeved copper-clad steel rods.

Quality Code C = may hold precise elevation but subject to ground movement. Examples: Metal rods with base plates less than 3 m (10 ft) deep; concrete posts (1 m (3 ft) or more deep); unspecified rods or pipe more than 3 m (10 ft) deep; large boulders; retaining walls for culverts or small bridges; footings or foundation walls of small to medium-size structures; or foundations such as landings, platforms, or steps.

Quality Code D = questionable stability. Examples: Generally, objects of unknown character; shallow set rods or pipe (less than 3 m (10 ft)); light structures; pavements such as streets, curbs, or aprons; piles and poles such as spikes in utility poles; masses of concrete; or concrete posts less than 1 m (3 ft) deep.

Accessibility

Accessible public property should be utilized where feasible. If the station is located on private property, permission must be obtained from the landowner for station accessibility. The name of the person or organization granting permission to occupy the station, and a telephone number, must be noted in the station description.

Final HARN Design

Following these guidelines, the Geodetic Unit established a HARN consisting of 215 existing control monuments and 242 new monuments. Monuments were constructed using the same steps as mentioned above for installing 3-D rod type monuments with the following differences:

- a. All metal components were made of stainless steel and were 14 mm (9/16 in) in diameter.
- b. Instead of disks, datum points 14 mm x 76 mm (9/16" x 3") were screwed onto the top rod section. If the top portion of a rod was sawed off, it was rounded with a grinder and then punch marked.
- c. Aluminum access covers were installed for all new HARN stations, on which the station name and year were stamped around the edge.
- d. A special large yellow witness sign was designed for preexisting and new HARN stations.

2-3.04 VERTICAL CONTROL MARKS - BENCH MARKS

Vertical control marks (bench marks) referred to in this section consist of standard geodetic disks of the type shown on Figure 2-3.01A. The marks are stamped with a bench mark designation and date, then cemented in or fastened to a permanently stable object.

A record of the description and recovery notes for all vertical control marks located in Minnesota is kept and maintained by the Mn/DOT Geodetic Unit. This inventory includes marks set by the Minnesota Department of Transportation, the National Geodetic Survey the U.S. Geological Survey (USGS), the Mississippi River Commission (MRC) and the U.S. Corps of Engineers (USCE).

For detailed instructions for setting these older vertical control marks as part of a mark maintenance project, the reader should contact the MN/DOT Geodetic Unit or reference **National Geodetic Survey Operations Manual, 1990**.

2-3.0401 General Instructions for Setting Vertical Control Marks

The choice of the location and type of bench mark are major factors in prolonging its life. Generally, when doing mark maintenance work, the location of the new mark will be in the vicinity of the old mark. For details on site location when setting new marks, see Section 2-5.0301 in this manual.

Selection of a site for establishing a vertical control mark requires consideration of stability and permanence. A final consideration is the availability of local reference ties to aid in describing and recovering the mark.

Stability

With respect to stability, the following methods are listed in order of preference:

- a. Exposed sections of bedrock or ledge-rock.
- b. Aluminum rods driven to refusal.

- c. Public building with obvious below-frost foundations. Care must be taken that the hole is drilled in a section that is directly supported by the foundation.
- d. Large concrete structure, such as bridges and dams.
- e. Concrete monuments - 1.5 m (5 ft) or more deep.
- f. Box culverts with head walls (not sectional).
- g. Large boulders, but select with caution to avoid frost movement.

Permanence

With permanence in mind, the site considerations are:

- a. When setting marks along highways, select a site near the edge of the right of way and on the outside of curves to increase their chance of survival. Anticipate future road construction, extension of box culverts, increased sight corner distance and borrow areas.
- b. With respect to railroads, avoid railroad grades, signals, or stations that may be abandoned and removed in the near future.
- c. Select public buildings that are not going to be abandoned or have additions in the near future.
- d. If two suitable sites are available for the same disk, the one most suited to recovery should be selected.

General

All disks are to be stamped before being set. Stamping a disk after it is set on a steel rod can cause the stem of the disk to bend and possibly loosen. Stamping a disk after it has been set in concrete can cause the mortar mix to crack and admit moisture.

A standard series of numbers and letters have been established for Mn/DOT Bench Mark designations. The four numbers identify the county and the section of highway. The letter (or letters) is generally in alphabetical progression from one monument to another. The progression is not necessarily in any particular direction but would normally begin at one end of the project and continue alphabetically through the appropriate S.P. Number (Section 2-5.0301 for details).

Bench mark designations for marks set by other agencies follow instructions written by those agencies. In all cases of mark maintenance work, the Mn/DOT Geodetic Unit shall be notified prior to any work to insure that the correct designation is stamped on the new mark.

The date of the setting of the bench mark shall be stamped at the lower center of the disk. If an unstamped Mn/DOT disk is found and no record of it is available, the disk shall be treated as a new mark and will be so designated using the current date. Under no circumstances shall the elevation of the mark be stamped on the disk as this elevation is subject to change from subsequent leveling.

When it is necessary to set a mark on private property, permission must be obtained from the land owner, preferably in writing.

Whenever possible, set a witness post within 1 m (3 ft) of the bench mark and fasten a "WITNESS POST" sign to it (Figure 2-3.0401).

2-3.0402 *Setting Precast Marks and Poured Concrete*

The purchase of six foot precast monuments was suspended in 1972. The driven rod type monument should now be used (Figure 2-3.02).

2-3.0403 *Setting Marks in Structures*

The structures in which vertical control mark disks are set vary in size and character from large buildings to large boulders. Bench mark disks may be set either horizontally (shank vertical) or vertically (shank horizontal) depending on the type of structure. When marks are set vertically, they are much less convenient to use, as a leveling rod cannot be placed on them. It is usually necessary to use a short rod in leveling to or from a disk set vertically. If disks are set vertically, care should be taken to see that the disk, because of its weight, does not loosen itself before the cement has set firmly. A general discussion on the various types of structures taken from pages 43-45 of **NGS Special Publication No. 239 Manual of Geodetic Leveling** is condensed below:

Bedrock, Ledge-Rock, Boulders - In setting a disk in a rock outcrop, care should be taken that the rock in which it is set is solid and that it is part of the main ledge and not a detached fragment. When bench mark disks are set in boulders, one should be sure that the boulder is of durable rock and that, in the matter of size and depth below the surface of the ground, it is at least the equivalent of the poured or pre-cast concrete monument. Boulders (not outcropping rock) located on steeply sloping hillsides should be avoided, as they tend to slide downhill with the passage of time.

Disks drilled in bed rock or ledge rock can be difficult to find as often a witness post cannot be set next to the disk. Disks should be made magnetic to insure their future recovery using a magnetic locator. Also, a sub-meter GPS position on the mark would aid in its recovery. Under all circumstances special care should be taken in making accurate, obvious ties.

Bridges - Large and well constructed bridges usually offer excellent sites for bench marks as they are usually well founded and will, in all probability, remain undisturbed for long period of time. Small bridges, which will soon have to be widened due to increased traffic, or antiquated bridges, not strong enough for modern loads, are poor places for bench marks and should be avoided when possible.

Culverts - Culverts are usually poorly constructed and subject to disturbance, except along main line railroads and the most highly improved modern highways. Good judgment in estimating the probable stability and length of life of culvert structures can greatly reduce the loss of bench marks.

Tower and Tank Foundations - These are usually quite stable to insure the stability of the superstructure.

Curbs, Sidewalks, Pavements, etc. - These are particularly poor places for bench marks because they are subject to settlement and heaving. They are also frequently changed.

The procedures to be used in setting a vertical control mark in any of the above structures are:

- a. Drill a 25 mm (1 in) diameter hole 76 mm (3 in) deep in the structure.
- b. Recess at surface with a reaming bit, 6 mm (0.25 in) deep x 100 mm (4 in) diameter hole, centered. All drill holes in rock or concrete are to be of sufficient depth to allow the edge of the disk to be flush with or slightly below the edge of the hole.
- c. Set a standard vertical control mark disk flush with the surface using concrete mortar. If the disk is set vertically, care should be taken to see that the disk, because of its weight, does not loosen itself before the cement has set firmly.

2-3.0404 Setting Rod and Disk Marks

Since 1972, monumentation completed by the Geodetic Unit on second order vertical control projects has been the rod type monuments, except for the placement of disks in structures. The rod type vertical control mark set during the period of 1972 - 1981 consisted of a rod-type vertical control mark disk, crimped or soldered to the top of a copper-coated steel ground rod. See previous section for detailed installation instruction.

After 1981, Mn/DOT began using aluminum rod type monuments for both horizontal and vertical control marks. The aluminum disk is fastened to the rod by a compression fit.

2-3.0405 Recovery of Vertical Control Marks

Since it is not practical to confirm the elevation of a vertical control mark due to the distance to the next such mark, a visual inspection should be made to determine any apparent movement, with the findings noted in the recovery note. A GPS receiver should be used to determine a coordinate position. The mark should be checked with a magnetic locator. Any monuments not magnetic should have a piece of steel or iron buried next to the mark, usually the north edge, and this must be stated in the recovery note. If practical, a metal witness post and sign should be placed near the mark. The "to reach" and local description of the monument should be checked and/or updated. Three photos of the monument should also be taken. The photos should include a close-up of the monument that is readable, an eye-level photo looking down at the monument, and a panoramic view listing direction photo was taken. When the recovery work is completed, a recovery note shall be written following the instructions in Section 2-3.06.

2-3.0406 Resetting Vertical Control Marks

Frequently, new construction or repair to existing structures necessitates the destruction of bench marks. As soon as it becomes known that a mark must be moved, the Mn/DOT Geodetic Unit shall be notified. The information needed is the bench mark designation, the reason for moving the mark, and the approximate time limitation. If the mark was established by the NGS, the information can be forwarded to the State NGS Advisor, to coordinate the field work needed in resetting the mark. For marks established by Mn/DOT, USGS, or USCE, the Mn/DOT Geodetic Unit accepts responsibility for scheduling the field work needed to reset the mark.

The proper procedure, in most cases, is to establish the new mark in a safe place near the old mark following the procedures detailed in the preceding sections. The new disk is to

be stamped with the old designation followed by the word "RESET" and the year that the new mark is set. For example, if a bench mark designated "2480 A 1973", needs to be reset during the year 1976, the new mark shall be stamped "2480 A RESET 1976". Never reset a bench mark using the same designation; if the old monument or vertical control mark disk is used for the new mark, stamp "RESET" and the date of reset below the old designation and date. After the new mark has been established, complete descriptions of the old and new marks, and leveling from the old mark to the new mark shall be completed on the NGS Form NOAA 76-60, **Report on Relocation of Bench Mark**. The instructions needed to complete this form are given in Section 2-3.0407. In addition to the information submitted on the NGS Form NOAA 7640, a recovery note of the old mark, (see Section 2-3.06) and a description of the new mark (Section 2-3.05) shall be submitted to the Mn/DOT Geodetic Unit.

2-3.0407 Report on Relocation of Bench Mark (NOAA 76-60)

The Mn/DOT Geodetic Unit recommends that this form be used for resetting all vertical control marks (Figure 2-3.0407A). The detailed instructions for leveling from the old mark to the new mark are given on the back of this form (Figure 2-3.0407B).

2-3.05 HORIZONTAL CONTROL MONUMENTS

Today, with the advent of GPS, conventional horizontal mark setting and maintenance as described in this section is almost non-existent. With limited human resources and new technologies it is more economical, in most cases, (HARN stations excepted) to allow the destruction of the control station and re-establish a new rod type station at a later date, if needed, using GPS. Poured concrete monuments are still being installed by other agencies and GPS is not always suitable in cases of overhead obstructions for mark maintenance.

For historical purposes, horizontal control marks referred to in this section consist of standard geodetic disks of the type shown on Figure 2-3.01A. A complete station consists of the surface and underground marks, two reference marks, and an azimuth mark.

Detailed instructions for setting horizontal control marks as part of a mark maintenance project are given in the **NGS Technical Memorandum C&GSTM-4: Specifications for Horizontal Control Marks, April 1968**, or the **National Geodetic Survey Operations Handbook (1991)**.

The Geodetic Unit shall be notified prior to performing any mark maintenance work to insure that the correct designations are given, and that the angle and distance measurements are completed correctly.

2-3.0501 General Instructions for Setting Horizontal Control Marks

The instructions given in this section refer to the procedures when doing mark maintenance work on previously established concrete horizontal control marks. For site location of horizontal control stations, refer to instructions for the reconnaissance phase of horizontal control surveys given in Section 2-4.0301.

The location of the station, depth and type of soil, presence of rock ledges, and the availability of materials will usually control the choice of the mark to be used. In most cases, the conditions are acceptable for the construction of concrete monuments. At each horizontal control mark location a set of five marked concrete monuments are generally constructed, consisting of the following:

- a. A surface station mark and underground mark.

- b. Two reference marks - Each reference mark is placed in close proximity of the station mark and located so as to avoid the probability of both marks being disturbed by the same cause. These marks should be set at a distance of 15 m to 60 m (50 to 200 ft) from the station, generally within one chain length or 30 m (100 ft), so that the angle formed at the station between the reference marks approaches 90°.

The reference mark disk (Figure 2-3.01A) bears an arrow that is set pointing towards the station mark. Reference marks are stamped with the name, date of station and numbered in sequence clockwise from north (for new marks).

For recovered stations where reference marks have been destroyed, new marks should be established to insure two or more good reference marks at each station. These marks are numbered with the next consecutive unused number, regardless of the existence or absence of any of the reference marks established previously.

- c. One azimuth mark - The azimuth mark is located approximately 800 m (½ mi) from the station with unobstructed ground-to-ground visibility between the station and the mark. At times, a contiguous traverse station will serve the same purpose as an azimuth mark, providing the station is not over one mile from the occupied station and has ground-to-ground unobstructed visibility. The azimuth mark disk (Figure 2-3.01A) bears an arrow that is set pointing towards the station mark.

A witness post is set about 1 m (3 ft) from the station mark and the azimuth mark whenever possible (Figure 2-3.0401). When it is not possible to set the post near the station mark, the post shall be set at a reference mark.

The following statements from the **NGS Technical Memorandum C&GSTM-4, April 1968**, summarize the instructions needed for monumenting and naming a horizontal control station:

On Naming of Stations:

The name as stamped on the mark will be used throughout the records.

The name of the locality is preferable but the name of the property owner may be used for the designation of the station.

Double names should be avoided, if practical, as they cause extra work throughout the recording and computing. Also, the double name including the word "PEAK", "MOUNTAIN" or "POINT" is not usually necessary, since the description should state that the station is on a peak or mountain of that name. Research of previously used names is required in order to avoid duplicate names of marks within a county.

On Rules and Examples for Marking Stations:

- a. Each newly established station shall be marked with a standard station mark disk, which shall be stamped with the name of the station and the year of establishment.
- b. Each reference mark disk shall be stamped with the name of the station, the number of the reference mark, and the year of establishment.
- c. Each recovered station that is remarked shall be stamped with the original name of the station, the original date of establishment, and the year in which it was remarked.

- d. Additional reference marks, as necessary, may be established when a station is recovered and reoccupied. The name and date shown above the arrow on the reference mark disk shall be the same as the original station, with the date established below the arrow.
- e. Do not renew an old reference mark. If it is in poor condition, either reinforce it or destroy it and set a new reference mark. It will be numbered with the next consecutive unused number, regardless of the existence or absence of any of the reference marks established previously.
- f. The abbreviation "Ecc." (for eccentric) should never be stamped on a disk. Its use in the records should be solely to indicate that the observations made at that point must be reduced to the station center.
- g. All new stamping on disks for station and reference marks shall be done with 5 mm or 6 mm (3/16 in or 1/4 in) dies.

On Station Mark:

An underground station mark should also be set under the surface mark whenever conditions permit.

The upper station mark may also be set underground when necessary, as when the station is in a cultivated field.

On Reference Marks:

In certain cases (for example, when a tower can no longer be built over a station because a power line has been constructed over it), a new reference mark may be established nearby, occupied as a station, and connected by a short traverse to the original station mark. In this case, an underground reference should also be established.

Additional standard reference marks should be established at recovered stations where needed to insure two or more good reference marks at each station.

On Azimuth Mark:

The principal purpose of an azimuth mark is to furnish an azimuth at each station which will be available to local surveyors or engineers from an ordinary ground set up, without the necessity of building any high towers.

The instructions given in this section are of a general nature and are not intended to be detailed enough to complete all of the work required when moving or resetting a horizontal control mark.

2-3.0502 Setting Poured Concrete Marks

The following information has been retained for this manual mainly for mark maintenance instructions and, in some cases, for other agencies that may prefer concrete over rod type monuments for economical or other reasons.

Most poured concrete horizontal control marks are set according to instructions given in the **National Geodetic Survey Operations Handbook (1991)**. Each station mark must have an underground mark set, as illustrated in Figure 2-3.0502. This is accomplished by using a plumbing bench to insure that the surface mark is set directly over the underground mark. Reference marks and azimuth marks need not have underground

marks set unless the mark is occupied and computed as a main station on the horizontal control network. A small piece of iron or steel should be placed in the concrete near the surface to make the monument magnetic so that it can be recovered using a magnetic locator. Magnets are not to be used because of their adverse effect on gravity meters.

The procedures to follow in setting poured concrete monuments for horizontal control marks are summarized below:

- a. Station Mark - Dig hole for the station mark 1.5 m to 2 m (5 to 6 ft) deep and a minimum of 35 cm (14 in) diameter at the bottom and 30 cm (12 in) at the top. (Figure 2-3.0502)
- b. Underground station mark - Pour a mass of concrete at least 25 cm (10 in) in diameter, and at least 15 cm (6 in) deep, at the bottom of the hole and set a station mark disk, stamped with the same designation as the surface mark, in the concrete and centered in the hole.
- c. Set a plumb bench over the hole and mark a plumb point over the underground mark. Then cover the underground mark with paper and 15 cm (6 in) of soil.
- d. Enlarge the bottom of the hole about 5 cm (2 in) or more and center a 30 cm (12 in) square tapered form around the top of the hole. Leave the form flush or projecting 5 to 10 cm (2 to 4 in), and centered over the plumb point of the underground mark.
- e. Fill the hole with concrete mixture. Shape and smooth the top and set the pre-stamped station disk under the plumb point of the plumb bench so the mark is exactly over the underground mark. Place a piece of iron or steel in the concrete to make the mark magnetic.
- f. Reference and Azimuth marks - Set these marks using the same procedures as for station marks except the dimensions may be 30 to 24 cm (12 to 10 in) at the bottom and top, respectively. An underground mark is not required.
- g. Measure the distances from the station mark to each reference mark and between the reference marks with a calibrated steel tape.

Measurements should be made horizontally, if possible, in both feet and meters, measured independently to 0.01 feet and 0.001 meters, respectively, such that the distances in feet and meters agree to 0.01 foot.

After the monumentation is completed as outlined above, a complete description for the horizontal control mark shall be written following the procedures in Section 2-3.06. When monumentation is being done as part of a mark maintenance project, a complete recovery shall also be written for the old mark following the procedures in Section 2-3.07.

2-3.0503 *Setting Marks in Structures*

Generally, the instructions given in Section 2-3.0403 for setting vertical control marks in structures also apply to setting horizontal control marks in structures. Exceptions and additions to Section 2-3.0403 are:

- a. Horizontal control mark disks are never set vertically in a structure as may be the case with a vertical control mark.
- b. Horizontal control marks must be set so that the mark can be occupied with a tripod setup over the mark.

Occasionally, it may be necessary to set a horizontal control mark on the roof of a building or on top of a high structure such as a water tower or tank. This is usually the case when doing a horizontal control survey in a large city.

When it is necessary to do this, the station mark may be monumented by setting the disk in a 30 cm (12 in) square block of wood and cementing the block to the roof surface. Another method is to make some identifiable point, such as a “punch-mark” or chiseled “X”, on part of the structure itself. The best method is to drill and set a standard station disk into the roof surface with the permission of building owner.

2-3.0504 Recovery of Horizontal Control Marks

Although the receipt of any information pertaining to a horizontal control mark is appreciated and provides assistance to the mark maintenance of the station, the following work is required when making a complete recovery of the station:

- a. The local description of all marks associated with the station will be verified and/or additional descriptive information obtained as necessary.
- b. The “to reach” for the station will be verified or corrected as appropriate.
- c. Any personal opinions such as the possibility of movement in the area should be noted on the recovery note with the reason for these opinions.
- d. When a discrepancy is noted from the original data, a reason should be given if known, e.g., original measurement to reference mark number 1 was apparently a slope measurement as the previous value can be checked using this procedure.
- e. The station mark, reference mark, and azimuth mark should be checked with a magnetic locator. Any monuments that are not magnetic should have a piece of steel or iron buried next to the mark, usually the north edge, and so stated in the recovery note.
- f. If the station is not marked with a witness post and sign, set a steel witness post and sign about 1 m (3 ft) from the station mark and the azimuth mark. If it is not possible to set a post near the station mark, the post should be set near one of the reference marks.
- g. Three photos of the monument should also be taken. The photos should include a close-up of the monument that is readable, an eye-level photo looking down at the monument, and a panoramic view listing direction photo was taken.

When the recovery work is completed in the field, a recovery note shall be written following the instructions in Section 2-3.07.

2-3.0505 Resetting Marks - Raising or Lowering a Station In Place

Horizontal control marks are always placed where they are least likely to be disturbed or destroyed, yet can be found without too much difficulty. New construction is anticipated as much as possible and locations that are likely to be affected are avoided. If destruction of a mark is likely, preserve the mark by either raising or lowering it in place. An alternative is establishing a new station in a safe location nearby and connecting it to the old station precisely so that it can be used in place of the original station.

The Mn/DOT Geodetic Unit should be notified as soon as it becomes known that a mark must be moved. The information needed is the station name, date of establishment, reason for moving the mark, and approximate time limitation.

If the mark was established by the NGS, the information can be forwarded to the State NGS Advisor to coordinate the field work needed in resetting the mark. For stations established by Mn/DOT, the Geodetic Unit will schedule the work needed in resetting the station. The NGS Form NOAA 76-109, **Observation of Horizontal Directions, Traverse and EDM Measurements Leveling**, shall be used for recording all measurements and pertinent information involved in resetting or relocating a horizontal control mark. For more details contact the Mn/DOT Geodetic Unit.

Occasionally, it may be necessary to reset a disk in a monument that is damaged or has badly deteriorated. This may be accomplished by setting straddles or a plumbing bench over the in-place disk and making elevation measurements on the disk before removing or repairing.

If the mark is also a bench mark, the procedures, for resetting a bench mark, detailed in Section 2-3.0406, must also be followed. If the mark being repaired is a station mark and it is necessary to remove the surface monument, the underground mark shall be checked from the plumbing bench or straddles. Any discrepancies should be carefully noted. After the monument has been repaired or reconstructed, the original disk shall be stamped with the current year in addition to the original stamping. The disk shall then be set in the monument using the plumbing bench or straddles. An elevation measurement should be made to determine the amount the new disk was raised or lowered, and a complete recovery report must be made following detailed instructions in Section 2-3.07.

When a station is to be raised or lowered because of impending construction work in the area, a full recovery of the station shall be made following the instructions in Section 2-3.0504.

Additional chainage ties or straddles should be made as necessary to assure that the mark will be reset in its original location and elevation measurements should also be made as described in the preceding paragraph. After the grading or construction work is completed, the old monument or a new monument and disk shall be reset at the original location and the measurements required for a full recovery observed and recorded in the same book (NGS Form NOAA 76-109) that was used to record the measurements at the original station, before the mark was destroyed.

The following examples of work required for replacing and raising or lowering a horizontal control mark are taken from instructions written by the NGS Mark Maintenance Engineer for the Minnesota area.

Case I. The reference and azimuth marks have not been disturbed, but the station surface mark has been broken off or removed.

The remainder of the surface monument should be removed, and a new surface mark established directly over the underground mark.

The same work specified under the recovery section for a horizontal control station should then be performed. Discrepancies from the original data should be noted in the descriptive material. This will enable decisions to be made at a later date as to whether the station was reset in its original position.

Case II. The station surface and underground marks have been destroyed, but the reference and azimuth marks are in their original position.

The original position of the station is located by determining the point where the original measurements from the reference marks intersect. A theodolite is positioned over this point and the directions are observed to the reference and azimuth marks, in addition to intersection stations that are visible.

These values should then be related to those previously observed to determine if the point occupied is where the original station was positioned.

The angular values between the azimuth mark and intersection stations are more reliable than the measurements from the reference marks. The angular values between the azimuth and reference marks are normally more reliable than the distances, but in this case the decision of reliability is left with the mark maintenance engineer.

The mark maintenance engineer must also decide if an astronomic azimuth is needed to determine the correct azimuth to the azimuth mark. This decision is based on the results of check angles observed. The final position of the reset station is then determined and a complete descriptive report prepared.

Case III. The station surface and underground marks and the azimuth mark are destroyed, but the reference marks are in their original position. No intersection stations are visible.

The reset station location is determined at the point where the original measurements from the reference marks intersect. The angle between the reference marks is then determined from this point and compared with the original observed value. Assuming that the angle closely agrees, the reset station is established in this location.

If agreement is not obtained, a decision must be made as to whether the original angle or distance measurements are more reliable. These are affected by the year of observation, distance to reference marks, recovery information for the station, etc. The station is then selected, and, if moved from the point determined from the measurements, final directions and distances are determined.

If possible, an azimuth mark will be established for the station. Due to the poor quality of the directions to the reference marks, an astronomic azimuth must be observed to determine the geodetic azimuth to the azimuth mark.

A complete descriptive report will be prepared explaining how the station was relocated.

Case IV. The station surface and underground marks and one reference mark are destroyed, but the azimuth mark and one reference mark remain.

Replacing a station with only these marks remaining requires trial and error observations. If an intersection station is visible, the problems are greatly reduced. The point where the original station was located is determined using the distance from

the reference mark in conjunction with the angle from the azimuth mark to the remaining reference mark. Trial and error observations are then made until the original values are obtained.

With only the azimuth and one reference mark remaining, it is then necessary to observe Polaris to confirm the azimuth to the azimuth mark. If the original value is not obtained, the point is moved (holding the distance to the reference mark) to where the correct azimuth is obtained.

When intersection stations are available and form strong angles at the station where observed with the azimuth mark, the azimuth may be confirmed by obtaining check angles. However, when the angles are weak, Polaris observations will be required.

As in all other cases, a descriptive report must be prepared explaining how the station was repositioned.

In all cases where the station surface and underground marks are destroyed, the description should explain how the point was re-established. This information will resolve many problems when the station is used in future surveys. If there is a question regarding the reliability of the new station, it should be stated with the reason for this belief.

The four cases illustrated above are examples of some of the more common situations that may be encountered when resetting a horizontal control mark. In all cases involving the resetting of a horizontal control mark, the Geodetic Unit shall be contacted first to review and make recommendations for the resetting and stamping of the disk.

2-3.0506 Relocating Marks - Moving a Station

Currently, with the advent of GPS equipment, it is far more efficient and economical to establish a new control mark rather than to relocate it. Follow the steps for new horizontal marks. Do not use the name of the former station. Choose a new name that is readily distinguished from the former station name.

2-3.0507 Project Report

When mark maintenance is completed at a horizontal control mark, the field measurements and descriptions recorded in NGS Form NOAA 76-109, described in the previous section, together with a type-written recovery of the old station (Section 2-3.07) and a type-written description of the new station (Section 2-3.06) shall be submitted to the Geodetic Unit for computation and processing for submittal to the NGS. The project report should contain most of the same information that is submitted with a Mn/DOT primary control survey to the NGS for publication (Section 2-4.03).

2-3.06 DESCRIPTIONS OF GEODETIC CONTROL MARKS

A detailed written description is required for each new permanent primary or secondary control mark established or an existing mark without a description.

The description shall be typed or written legibly on the standard Mn/DOT form, "Description of Geodetic Control Mark" (Figure 2-3.06). It shall describe the location of the mark in enough detail so that anyone may readily recover the mark without the use of a map.

The Geodetic Unit follows the specifications stated in the U.S. Department of Commerce, National Oceanic and Atmospheric Administration, National Ocean Service, Coast and Geodetic Survey **Input Formats and Specifications of the National Geodetic Survey Data Base.**

The description form shall be sent to the Geodetic Engineer. The Geodetic Unit will review the description, make the necessary copies, and distribute the original and copies to the appropriate agencies.

2-3.0601 Description of Geodetic Control Marks

This form (Figure 2-3.06) is used for describing all Geodetic Control Marks (2nd Order or better horizontal, 3rd Order or better vertical) or marks found for which a description in the Geodetic Database does not exist.

The Mn/DOT description form shall be completed as follows:

Name: (Required) - The name of the station.

County: (Required) - The name of the county where the monument is located.

State: (Required) - Enter the name of the state where the monument is located, e.g., MN, SD, ND, WI. Use capital letters.

1/4 Sec: - Enter the quadrant of the section the mark is in.

Sec: - Enter the number of the section.

Twp: - Enter the number of the township.

Rng: - Enter the number of the range.

Lat: (Required) - Enter as accurate a reference latitude here as possible. (Use a handheld GPS receiver if possible).

Long: (Required) - Enter as accurate a reference longitude here as possible. (Use a handheld GPS receiver if possible).

USGS Quad: - Enter the name of the USGS quadrangle map.

County Map Sht #: - Enter the map sheet number the mark is on.

Date-set: (Required) - Enter the date the mark was set.

Agency: (Required) - Enter the initials of the establishing agency in capital letters, e.g., NGS, CGS, USCE, USGS, MRC, or MNDDT. (Note: MNDDT is the NGS assigned standard abbreviation for Mn/DOT in the National Geodetic Data Base)

Set-by: - Enter the name of the person in direct charge of the field measurements associated with the description.

Monument Type/Set code: - Code used to identify the type of monument

Entry	Description
07	Concrete Monument
34	Concrete Footing
38	Bridge Abutment
50	Aluminum Rod

Give an accurate description of how the mark was set and the setting the mark is in (i.e. Horizontal Control Disk set in a concrete monument, Punch Mark on a driven stainless

steel rod, Bench Mark disk set in bridge railing). The Geodetic Unit can assign the correct code if we have an accurate description, especially when a photo is available.

Disk Type: - This field identifies the datum point for the mark.

Entry	Definition
DB	Bench Mark Disk
DD	Survey Disk
DE	Triangulation Disk
DH	Horiz Cont Disk
DR	Ref Mark Disk
DZ	Azi Mark Disk

Accurately describe the datum point. Include photo.

Depth: - This area pertains to driven rod type marks. Record the amount of rod driven to the nearest 300 mm (1 ft) here. This field helps to determine the overall stability of the mark, and is **required** for any rod type marks set.

F/P/R: - Relationship between the monument and the surface of the ground.

F	Flush
P	Projecting
R	Recessed

Inches: - The distance from the surface of the disk or datum point to the surface of the ground.

Mag Code: (Required) - This pertains to the magnetic properties of the mark.

Entry	Description
N	Non magnetic
M	Bar magnet in disk
I	Steel rod
R	Steel rod imbedded in monument
S	Steel spike imbedded in monument
T	Steel spike adjacent to monument
O	Other

Trans: (Required) - This is a one-letter code that indicates the mode of transportation needed to reach the mark.

Entry	Definition
B	Boat
C	Car
T	Truck (3/4 ton)
X	Four-wheel Drive Vehicle
O	See text

Pack: - If time is needed to pack equipment to the mark, note the time here in the format HH:MM.

GPSable?(AP): - This code is used to tell people whether or not a mark is suitable for receiving satellite signals.

Entry	Definition
P	Site suitable for receiving satellite signals
O	See text
N	Site not suitable for receiving satellite signals

Photos: - Place a check mark in the box next to each photo after it has been taken. Also circle the direction that the photographer was facing when the panoramic photo was taken.

Stamping: (Required) - Enter the actual stamping of the mark including the name, date, and elevation (if stamped on disk). Do not include the inscriptions that are already die-cast into the disk by the manufacturer. Do not use quotation marks, commas, dashes, periods, etc., if they are not part of the stamping. If the stamping was done in capital letters, capital letters will be used on the description form (e.g. 2480 AC 1973, TT 18 MT 1934, or C 112 RESET 1975). Separate letters and numbers with a space.

(Note: Do not leave this field blank. If the mark is not stamped, then write or type **UNSTAMPED**).

Bridge #: - This only needs to be filled in if the mark is actually set in a bridge, such as the abutment, railing, pier, or sidewalk.

Distance and direction from nearest town: - Enter the straight line distance to the nearest 0.1km and the direction to the nearest sixteenth point of a compass from a well defined point in the town. Try not to use the names of towns that are so small they do not appear on the state highway map.

Example #1: 2.2 mi NORTH of DULUTH

Example #2: in ROCHESTER

OPTIONAL: Use this part only if the mark is set in a bridge or a box culvert

Example: in ABUT at SE cor of TH 55 BRDG NO 65762 over FAI394

TO REACH: - In this paragraph, describe the direction and route to follow from a well-defined geographic position to the general location of the mark. Well-defined geographic positions include highway junctions, other marked roadway intersections, and prominent, unique structures such as a community's water tank or post office. This description should allow one to get within 0.1 km (0.1 mile) of the mark. If the mark is along a trunk highway, the milepoint to the nearest 100 m (0.05 mile) should be stated.

Example #1: 0.15 mi EAST along TH 60 from jct of CO RD 1 and TH 60 in MAZEPPA, at TH 60 MP 187.05,

Example #2: 4.3 mi EAST along TH 14 from jct of TH 63 and TH 14 in ROCHESTER to TH 14 MP 217.9, thence 3.9 mi NORTH on CO RD 11,

LOCAL TIES: - List the local reference ties. The first reference tie should be from the centerline of the last roadway stated in the "TO REACH", e.g., 12.0 m (39.5 ft) south of TH 2. All ties made to roads, driveways, telephone poles and lines, power poles and lines, imaginary extensions of lines, drainage structures and trees should be made from the centerline or center. Whenever possible, select reference points that will probably still exist in 10 or 20 years.

Specify distance measurements to the accuracy of the field measurements. Do not show more accuracy than warranted by field measurements. Specify direction to the nearest 16 points of the compass. Do not abbreviate the cardinal directions of the compass.

Whenever possible give the identification numbers of reference points such as telephone and power poles, telephone pedestals, and bridges. If the reference point is a tree or a drainage structure, state the size and type.

2-3.07 RECOVERY OF 3D CONTROL MARKS

This area applies to marks that are already fully described in the Mn/DOT Geodetic Database. If a mark has already been set, but not in the Geodetic Database, a description (see Section 2-3.06) should be done on the mark.

The main purpose of a recovery report is to update the information about a mark so that it can be easily recovered. When making a recovery, look at the original description and try to improve it wherever possible. If the original is missing a "to reach" or a milepoint reference, please remedy this at the time of the recovery.

Any recovery information for a mark in the Geodetic Database should be made in red ink on the latest copy of a printout from the Geodetic Database and submitted to the Mn/DOT Geodetic Engineer. Refer to Section 2-3.0504 for requirements.

In addition, the date of the recovery must be noted, along with the inscription and the type of mark (MNDT bench mark disk, USC&GS triangulation station disk), and a statement must be made to the mark's availability to receive GPS satellite signals (any overhead obstructions). Three new photos are needed for a recovery.

Also, for horizontal control marks with reference marks, the distance between the station and the reference marks must be chained and recorded. This helps determine the stability of the mark.

If the mark was searched for and not found, give a brief statement as to the extent of the search and your best reason for not being able to find the mark. In some cases Mn/DOT may be able to recover damages from the responsible party for the destruction of the mark. Gather any evidence such as photographs of the site or interviews with witnesses to aid in recovering compensation.

If the control mark has been destroyed and the disk is recovered, please send the disk, along with the recovery note, to the Geodetic Engineer. The Geodetic Unit will review the recovery, update the database and make the necessary copies and distribute the information to the proper agencies.

2-3.08 PRESERVING GEODETIC CONTROL MARKS

The majority of these marks are located on or adjacent to highway or railroad right of way and are subject to loss or disturbance by road construction, utility installation, and maintenance operations. Mark losses also result from farming operations, private land development and indirectly from outdated ties and descriptions. To insure preservation and availability of geodetic marks, it is essential that the establishing agencies and users of geodetic control take an active part in maintenance of these marks. Particularly important are the 481 HARN control marks throughout Minnesota. A considerable amount of time and money have been expended for the installation and positioning of these marks. In a recent court case in Colorado, the DOT charged a utility company \$40,000 for destroying one HARN station. Mn/DOT has limited resources for mark maintenance and mainly concentrates efforts at minimizing the loss of marks by keeping description and recovery notes current.

2-3.0801 Witnessing Marks

All permanent geodetic control marks established to first, second or third order standards must be referenced by chainage ties to nearby, well-defined objects (i.e., trees, poles, fence corners, witness post, roads, etc.). Distance and direction ties to landmark objects, nearest town and location with reference to section and land lines are also required. Since 1993, the distance and direction to the monument are stamped on the witness post sign.

2-3.0802 Notification of Proposed Construction Plans and Pending Mark Destruction

In order to perpetuate the existence of all geodetic control marks located on proposed construction or land grading projects, it is necessary that the Geodetic Unit or District Surveys Section be notified well in advance of all such work so marks can be recovered and the necessary action taken to preserve them.

Prior to surveying or grading on any project, surveyors or users of survey control should refer to a NGS geodetic control diagram or a Mn/DOT county control map for location of marks. When a mark is found that is subject to destruction, the NGS Geodetic Advisor, Geodetic Engineer or District Surveys Engineer should be notified for necessary action to save the mark.

When new construction endangers a geodetic control mark, a copy of the construction plans showing the position of the mark with respect to the proposed construction is very helpful in determining what must be done to preserve the mark. In any case, the geodetic control mark designation and year that it was set should be taken from the information stamped on the disk.

2-3.09 FUTURE OF GEODETIC MONUMENTATION

2-3.0901 Continuously Operating Reference Stations (CORS)

The CORS network, coordinated by the NGS, currently consists of GPS reference stations dispersed throughout the U.S. The code range and carrier phase data from these stations are for post processing applications and can be accessed over the internet. The

NGS has also made arrangements to use numerous Differential GPS (DGPS) stations operated by other governmental agencies such as the US Coast Guard, US Army Corps of Engineers and the Federal Aviation Administration. Ultimately, the CORS network is expected to consist of 100-200 stations located nationwide.

2-3.0902 Traditional Geodetic Marks

Traditional geodetic marks will continue to be needed long into the future. Surveyors using real-time GPS techniques will continue to use them to validate their techniques and procedures. Surveyors who cannot use real-time GPS techniques need to include these marks as part of their surveys to tie them to the NSRS coordinate system.

2-4 HORIZONTAL CONTROL

2-4.01 GEODETIC DATUMS

In simplest terms, a geodetic datum consists of a reference ellipsoid that is fixed in some manner with respect to the physical earth. It is important to note that a reference ellipsoid itself does not constitute a datum. An ellipsoid approximating the shape of the geoid in a limited region and having a specified relationship to a point in the region (the origin) forms a regional or local datum. An ellipsoid approximating the shape of the entire global geoid and having its center at the earth's center of gravity (the geocenter) forms a global or geocentric datum.

At a point of origin, where astronomic latitude and longitude are determined, a regional or local datum is defined by seven additional parameters:

- a. Semimajor axis of the reference ellipsoid.
- b. Flattening of the reference ellipsoid.
- c. Component of the deflection of the vertical in the meridian at the datum origin.
- d. Component of the deflection of the vertical in the prime vertical at the datum origin.
- e. Geodetic azimuth from the origin to another point in the system.
- f. Geoid height at the datum origin, i.e., the difference between the ellipsoid and the geoid at the origin.
- g. The condition that the ellipsoid semi-minor axis be parallel to the rotational axis of the earth.

The simplest datum uses a single astronomic position point as datum origin, and the ellipsoid and geoid are assumed to be coincident and tangent at the origin (see Figure 2-4.01).

The following definitions are from the "Wisconsin Coordinate Systems" published in 1995 by the Wisconsin State Cartographer's Office. They are common terms used in discussing geodetic datums.

Ellipsoid

A mathematical surface (an ellipse rotated around the earth's polar axis) which provides a convenient model of the size and shape of the earth. The ellipsoid is chosen to best meet the needs of a particular geodetic datum system design.

Datum

A mathematically defined reference surface used to represent the size and shape of the earth. A horizontal datum is defined by its ellipsoid, latitude and longitude orientation, and a physical origin. The two most commonly used horizontal datums in Minnesota are the North American Datum of 1927 (NAD 27) and the North American Datum of 1983 (NAD 83).

Geoid

An undulating surface represented by extending the earth's mean sea level through the land areas. The geoid is a theoretical surface perpendicular at every point to every direction of gravity.

Geoidal separation

The perpendicular distance between the geoid and the reference ellipsoid at a point. A negative geoidal separation indicates that the geoid is below the ellipsoid. In Minnesota, the geoid separation is roughly 30 meters and is a negative value.

Projection

The method used to transform and portray the curved surface of the earth as flat (map) surface. Although there are theoretically an infinite number of possible projections, a relatively small number are commonly used. Different projection systems have differing amounts and patterns of distortion.

National Horizontal and Vertical Control Datums:

NAD 27	North American Datum of 1927.
NGVD 29	National Geodetic Vertical Datum of 1929.
NAD 83	North American Datum of 1983.
NAVD 88	North American Vertical Datum of 1988.

Minnesota adopted the North American Datum of 1927 (NAD 27) and the State Plane Coordinate System in 1945. NAD 27 is based on the Clarke 1866 Ellipsoid. In the 1970s and 1980s, the military needed to improve its ability to accurately deliver both strategic and tactical weapon systems on a global scale. Available terrestrial measurement activities were combined with information gathered from space-based satellites to provide a better geoid model. This new geoid model resulted in new ellipsoids, centered on the earth's mass, which provided accurate mapping on a global scale. Three of these new ellipsoids (Table 2-4.01) were the Geodetic Reference Systems of 1980 (GRS 80), the World Geodetic Spheroid of 1972 (WGS 72), and the World Geodetic Spheroid of 1984 (WGS 84). The Geodetic Reference System of 1980 was adopted for international use by the XVII General Assembly of the International Union of Geodesy and Geophysics at their meeting in Canberra, Australia in December 1979. The US Department of Defense chose the World Geodetic Spheroid of 1972 for its worldwide navigation strategy until January 1986 when it switched to the World Geodetic Spheroid of 1984. For all practical purposes, including boundary and geodetic surveying, the World Geodetic Spheroid of 1984 and the Geodetic Reference Systems of 1980 can be treated as the same.

ELLIPSOID NAME	EQUATORIAL RADIUS (a)	POLAR RADIUS (b)	FLATTENING $f = (a-b)/a$
CLARKE 1866	6378206.4	6356583.8	1/294.98
GRS 1980	6378137	6356752.3	1/298.257222100
WGS 1972	6378135	6356750.5	1/298.26
WGS 1984	6378137	6356752.3	1/298.257223563

Table 2-4.01 Ellipsoids

The Coast and Geodetic Survey chose to adopt the Geodetic Reference System of 1980 as the reference ellipsoid for a readjustment of its vector database, to replace the one from the 1920s (NAD 27). The horizontal segment of this adjustment is called the North American Datum of 1983 (NAD 83). The vertical segment is called the North American Vertical Datum of 1988 (NAVD 88). It is imperative to remember that there is no exact correlation or translation between

North American Datum of 1927 and North American Datum of 1983. This is also true for translation between the National Geodetic Vertical Datum of 1929 and the North American Vertical Datum of 1988. Any translation must be an interpolation based on points with known coordinates in each projection. The Coast and Geodetic Survey provides computer software called **NADCON** and **VERTCON** to accomplish this interpolation. These programs and others are available through the Internet at the NGS World Wide Website:

http://www.ngs.noaa.gov/products_services.shtml.

The HARN resulted in a readjustment of the geodetic network based on NAD 83. The HARN observations, completed from 1993 to 1996 using high precision GPS techniques, were adjusted by the National Geodetic Survey. The entire geodetic network in Minnesota was readjusted, holding the HARN stations fixed. The predicted shifts of the NAD 83 HARN adjustment compared to NAD 83 (1996 adjustment) are illustrated in Figure 2-4.01B. The shifts are relatively small for mapping purposes, ± 0.03 ~1 meter (± 0.1 ~3.3feet), but significant for geodetic control surveys.

The readjustment of the National Spatial Reference System (NSRS) began June 2005. It will be completed in 2007. This readjustment will provide NAD 83 (NSRS) and International Terrestrial Reference Frame (ITRF) coordinates.

Additional information can be found at: <http://www.ngs.noaa.gov/NationalReadjustment/>

2-4.02 COORDINATE SYSTEMS`

Of the many horizontal coordinate systems that exist, the Mn/DOT Geodetic Unit is concerned only with the following five: Geodetic Position; Universal Transverse Mercator; Minnesota State Plane; Project Coordinates; and since 1986, Minnesota County Coordinates. Before 1986, all of Mn/DOT's horizontal information was referenced to NAD 27.

After August 1986, Mn/DOT began using the newly published NAD 83 and the Minnesota County Coordinate System, which is a ground coordinate projection based on NAD 83.

The following definitions are from the "Wisconsin Coordinate Systems" published in 1995 by the Wisconsin State Cartographer's Office. They are common terms used in discussing coordinate systems.

Geographic system:

The network of curved lines (latitude and longitude) representing the earth's spherical surface. These coordinates are measured in angular values of degrees, minutes, and seconds, and are based on the equator and an arbitrary location of a prime meridian as the origin location.

Rectangular system:

A network of two sets of straight parallel lines intersecting at the right angles and superimposed on a map projection. The origin (zero point) is located based upon the area covered on the earth. Coordinate values are usually expressed in feet or meters.

Standard line (Standard parallel):

A defined line in a map projection along which the scale of the ellipsoid and the map projection plane are equal. It is a line of distortion along which the scale factor is equal to 1.0. Many map projections have two standard lines. For example, in Lambert projections, the north latitude and the south latitude (sometimes called the first and second standard parallels, respectively) are lines of latitude where the scale factor is equal to 1.0 on the ellipsoid.

Central meridian:

Central line of origin through the area of interest, used in many rectangular coordinate systems to orient the coordinate grid.

Actual origin, false origin:

The *actual* point of origin (zero point) for the coordinate system, as distinguished from false origin. The *actual* origin is the true geodetic origin of the system, but it may be assigned arbitrary coordinate values to eliminate negative coordinates in the system (this is done using false easting and/or northing). The *false* origin is an assumed point, typically to the west and south of the projection area, which has a coordinate value of 0.0.

False easting, false northing:

A numerical constant used to eliminate negative coordinates in a system, or to change the coordinates to more convenient values. The false easting and/or northing values are assigned to the true origin of the projection system.

Design elevation:

The elevation of the map projection surface. Regional coordinate systems are usually designed at mean sea level. However, the design elevation of a local coordinate system typically represents the median elevation in the area.

Scale factor:

A ratio, at a given point, of projection (grid) distance to ellipsoid distance. Because the transformation of the ellipsoid to a flat surface creates distortions, the scale factor on a map varies from place to place. A value larger than one (e.g., 1.0001) means the scale at a given point is larger than actual (or “scale greater than true”). A smaller value (e.g., 0.9999) means the scale is less than true.

Ground to grid ratio:

This statistic expresses the difference between distances calculated on the grid surface and distances measured on the ground. Small ratios (e.g., 1:500000) indicate less difference, while larger ratios (e.g., 1:5000) indicate more difference. Converting a ground distance to a grid distance requires the combination of two factors, the *scale factor* and the *elevation factor*, which relates ground distances to ellipsoid distances.

Units of Measure (Linear):

Rectangular coordinate systems may use meters, international foot, or the U.S. Survey Foot as the unit of measurement (most surveying and mapping work at the local level is based on the U.S. Survey Foot.) When a conversion from one of these units to the other is performed, it is important to ascertain which standard foot (U.S. Survey or international) is involved. The international (S.I.) foot, based upon a redefinition of the meter in 1959, is equivalent to 0.3048 meter. The U.S. Survey Foot, upon which many years of land tenure information and legislation are based, retains the 1893 definition of 1200/3937 meter. Note: When converting from English to metric units, Minnesota surveyors are required to use the U. S. Survey foot with the State Plane Coordinate System. The Minnesota County Coordinate System also uses the U.S. Survey Foot.

2-4.0201 Geodetic Position (Latitude, Longitude)

This is the basic horizontal portioning system. It is global in scope and requires special equipment and procedures for accurate determinations. Once a reference ellipsoid (spheroid) has been chosen, position in three-dimensional space can be expressed by two angles and height above or below the ellipsoid. This is the familiar latitude, longitude, and height system (Figure 2-4.0201).

Latitude (ϕ) is measured with respect to the equatorial plane-positive values for the southern hemisphere.

To measure longitude (λ), a reference meridian plane must be chosen. Geodesists have chosen the Meridian plane that passes through a point at the Greenwich Observatory in England. Positive longitude values are in the eastern hemisphere; negative longitude values are in the western hemisphere. Height is measured above (positive) or below (negative) the ellipsoid along the normal to the ellipsoid at the point of latitude and longitude.

2-4.0202 *Universal Transverse Mercator Projection (UTM)*

The UTM system is plane rectangular coordinate projection system employed as the international coordinate reference datum. The coordinate values, mathematically determined from geographic positions, are expressed in meters, with grid values given in terms of grid eastings and grid northings.

The UTM projection and coordinate system was developed by the Department of Defense for military purposes and is a global coordinate system. The UTM projection has 60 north-south zones arranged edge-to-edge around the equator.

The zone width (6 degrees) was chosen to maintain a scale difference of no more than 1 part in 2,500. Zones in the UTM system are numbered from west to east starting at the 180th meridian. Minnesota falls almost entirely in Zone 15. The origin for each zone is at the intersection of the zone central meridian and the equator. A false coordinate easting value of 500,000 meters is assigned to the central Meridian to avoid negative coordinate values.

With the introduction of NAD 83, the specific parameters of the UTM system were not redefined. However, the user should be aware that this datum difference causes a “shift” in coordinate values. The differences in Minnesota amount to roughly 200 meters in northing, 10 meters in easting, and are traceable to the use of a different ellipsoid and datum definition plus the removal of geodetic network errors.

The national series of topographic maps published by the U.S. Geological Survey (Quadrangle sheets) carry the UTM grid values with 1000-meter grid ticks. The UTM system provides a possible useful basis for an index of National Data Bank Information system.

2-4.0203 *Minnesota State Plane Coordinate System*

The State Plane Coordinate (SPC) system was introduced nationally in the 1930s by the U.S. Coast & Geodetic Survey to accommodate the needs of surveying, mapping and engineering projects. Based on both the Lambert Conformal Conic and Transverse Mercator projections, State Plane Coordinate systems were developed for every state such that there would be no more than one foot of distortion in every 10,000 feet of distance (on the ellipsoid). The scale of the Lambert Conformal Conic projection varies from north to south: therefore, it is used mostly for areas that extend in an east-west direction. The Transverse Mercator projection varies in scale in an east-west direction, making it most suitable for areas primarily extending north and south.

There are three zones in the Minnesota State Plane Coordinate System: South, Central, and North. All are based on the Lambert Conformal Conic projection. The division between adjacent zones occurs along various county lines. Figure 2-4.0203 shows the boundaries of the three zones. Provision for overlap exists, so points near a boundary may be calculated on each of the two pertinent zones.

Each state plane is an imaginary plane surface that cuts through the surface of the earth along two latitudinal lines within the zone. It is along these lines that the scale factor is 1.0. In the center of a zone the plane is below the ground surface, while it is above the ground in the northern and southern portions of the zone.

For the NAD 27, the state plane coordinates are x and y values on a Cartesian grid in units of feet, whose ranges of values are from 1,000,000 to 10,000,000 feet for x and 100,000 to 1,000,000 feet for y.

A more recent horizontal datum, the North American Datum of 1983 (NAD 83), was developed by the National Geodetic Survey in the 1980s. As a result, the SPC system was redefined based upon the new NAD 83 datum and published in meters, rather than feet. In addition, SPC 83 was assigned a different false easting and false northing than SPC 27 so that coordinate values in the two systems could easily be distinguished.

2-4.0204 Project Coordinate System

Mn/DOT used Project Coordinates, based on NAD 27, during the time period of approximately 1968 to 1986. In 1986, Mn/DOT introduced the new Minnesota County Coordinate System based on NAD 83 and began the transition from Project Coordinates to County Coordinates.

As used by the Mn/DOT, a project coordinate system is a Cartesian coordinate grid system that has its imaginary plane lying quite close to ground and covers an area of generally 1 degree of longitude by 15 minutes of latitude. In most cases, a measured ground distance will agree within 1 part in 30,000 with the distance value determined by project coordinates. This is the case, as long as both ends of the line are in the same project zone and no large elevation difference exists between ends of the line.

The range of project x-coordinate values is from 200,000 to 1,000,000 feet, while the project y-coordinate values range from 10,000 to 200,000 feet. These ranges differentiate project coordinate values from state plane coordinate values by a factor of ten, more or less.

2-4.0205 County Coordinate System

In the summer of 1984, the Geodetic Unit of the Minnesota Department of Transportation and the University of Minnesota Department of Civil and Mineral Engineering began a joint project to investigate the practicality of establishing a County Coordinate System (CCS) tied to the National Spatial Reference System (NSRS).

There were two basic reasons for starting the project at this time. First, it was felt that the existing SPC system was not being fully or adequately utilized. Likewise, Project Coordinate Systems, which are essentially modified versions of the SPC system, were not proving to be adequate. Second, the rapidly developing interest in implementing multi-purpose cadastres to land information systems make it imperative that there be a practical way of utilizing the NSRS.

For the County Coordinate System (CCS), the projections that are of interest are the two used for the State Plane Coordinate System: the Lambert Conformal Conic projection and the Transverse Mercator projection.

The fundamental requirement for a CCS is that grid and ground distances agree within some established and accepted precision. Selection of a limiting value of precision is somewhat arbitrary, but it is a basic prerequisite for establishing a CCS. The following values have been selected as the governing criteria for a Minnesota CCS:

- a. Ratio of precision within the St. Paul-Minneapolis Metropolitan Area and Duluth: no less than 1 part in 100,000.
- b. Ratio of precision in rural areas: no less than 1 part in 50,000.

These two ratios include both the scale factor and the elevation factor. Therefore, a ground distance measured in the Metro Area would differ from the corresponding grid distance by no more than 1 part in 100,000.

To accomplish this it was necessary to examine each county in the state individually. For each county a pair of standard parallels (for the Lambert projection) or a central meridian (for the Mercator projection) was selected. An average elevation was also selected and used to calculate the basic parameters for the county's coordinate system.

Figure 2-4.0203 illustrates the relationships of the various coordinate projections to the ellipsoid and geoid (sea level). Figure 2-4.0205A compares ground distance to sea level distance and state plane grid distance. Figure 2-4.0205B illustrates the 64 county coordinate zones on the state map and the three State Plane zone boundaries.

Upon request, Mn/DOT provides the two software programs that converts coordinates between any of the following NAD 83 coordinate systems:

Geodetic Position
UTM Zone 15 N Extended
Minnesota State Plane Coordinates
County Coordinates

For a copy of the program or for questions about **CONAD 83** and **MNCON** please contact:

Mn/DOT
Survey Support Unit
(651) 296-1074

2-4.03 MN/DOT PRIMARY HORIZONTAL CONTROL SURVEYS (NGS PUBLISHED FIRST ORDER)

For a general discussion of Mn/DOT primary control refer to Section 2-1.0201 in this manual.

The basic national horizontal control network of the United States consists of arcs of first order triangulation spaced about 96 km (60 miles) apart in the North-South and East-West directions. The areas between these basic arcs are then filled in with networks of second order triangulation. The National Geodetic Survey's Geodesy Division had the primary responsibility of providing Primary first and second order horizontal control networks by triangulation. The Mn/DOT Geodetic Unit has the responsibility of providing primary first order control for highway projects within these basic networks of triangulation.

Currently, surveys are performed according to the Federal Geodetic Control Committee's (FGCC) bulletins **Standards and Specifications for Geodetic Control Networks** (1991) and **Geometric Geodetic Accuracy Standards and Specifications for Using GPS Relative Positioning Techniques** (1989). Copies of these publications may be obtained from the National Geodetic Survey, Washington, D.C.

2-4.0301 *Field Specifications and Records*

In 1985, the Geodetic Unit began making the transition from using conventional (theodolites/EDMs) surveying instruments to using GPS instruments for positioning primary control. Some procedural changes were necessitated by this conversion. Intervisibility between control stations was no longer necessary; however, there could no longer be any overhead obstructions blocking satellite reception. For detailed instructions performing primary control surveys using GPS instrumentation, the reader is referred to the last FGCC bulletin mentioned above and to the **National Geodetic Survey Operations Handbook**. The four principle phases of field work involved in the performance of primary horizontal control surveys using GPS are: Reconnaissance, Monumentation, Session Planning, and Instrumentation. The reader should contact the Geodetic Unit if more detailed information is needed.

a. **Reconnaissance:**

After the need for a second order horizontal control survey has been established and approved, a reconnaissance survey is required to determine the best locations for placement of control stations. The choice of location and accessibility are important factors in selection of station sites.

The following procedures apply to reconnaissance for first-order horizontal control surveys:

1. Make a search for and recovery of all existing primary geodetic control marks (horizontal and vertical) in or near the project limits and write a recovery report for each (Section 2-3.06 through Section 2-3.07).
2. Select GPS station pair sites approximately every 5 km (3 miles) along the traverse route. Sites need an unobstructed overhead view between 15° and 90° altitude. An obstruction plot should be produced for any problem site, then compared with a correlating satellite visibility plot to determine the best observation times.
3. The main station and its pair (azimuth site) should be placed 0.8 km to 1.6 km (0.5 mi to 1 mi) apart with ground to ground inter-visibility.
4. For network design, geometry, and connection specifications for first order accuracy standards, see Table 2 in **Geometric Geodetic Accuracy Standards and Specifications for Using GPS Relative Positioning Techniques** (FGCC 1989).
5. When selecting station sites, priority should be given to areas that provide permanency, accessibility, and satellite visibility, preferably on public property. Sites should be chosen so that a vehicle can be parked less than 30 meters away allowing the GPS receiver to remain in the vehicle using a 30 m antenna to receiver cable. Avoid areas that could cause multipathing, which is the reflection of GPS satellite signals by "flat or metallic surfaces such as buildings, fences, or vehicles" (**NGS Operations Handbook**). Also, areas near high power radio, radar, or other transmission antennas should be

avoided, especially those using frequencies between 1227.6 and 1575.42 MHz.

6. Obtain permission from the property owner to set and use monuments. It is a legal requirement to make arrangements with **Gopher State One Call** for utility locations prior to monumentation.
7. Name each station by selecting of a name in following order of preference: locality (town, city, twp.), prominent landmark feature, name of locality, or name of property owner of land where mark is to be set. Avoid using double word names. Names must not be duplicated within a county and preferably not within the state.
8. Write reconnaissance descriptions for each station site (Section 2-3.06).
9. Plot locations of all old and proposed stations on a map (quad or county).
10. Prepare a preliminary project report for the field.

b. Monumentation:

After the reconnaissance survey has been completed and any nearby utilities located, monument the project using standard three dimensional control mark disks set and referenced according to detailed instructions given in Section 2-3.02, "Three Dimensional Monuments." Install these marks at the same exact location of the lath set on the reconnaissance survey.

c. Mission/Session Planning:

The GPS satellites orbit around the earth every 11 hours and 58 minutes in a constellation consisting of six groups, each containing four satellites. The rise and set time of each satellite becomes earlier by four minutes each day. When planning GPS sessions, the Field Supervisor must take into consideration when there are at least four satellites in view and the corresponding Positional Dilution of Precision (PDOP).

Session planning involves the following steps:

1. A plot must be made, displaying all the control stations that are to be occupied and the planned vectors between them. Normally 10% of the control is triple occupied and the rest are double occupied.
2. Sessions are numbered using first the Julian date, followed by consecutive alpha numbers: e.g., 030-A means the first session for January 30th.
3. Lengths of sessions, in minutes, are determined by the following formula, with 30 minutes being the minimum for a static GPS survey:

$$\text{Minutes} = \frac{\text{Maximum Base Line (m)}}{125} \times \frac{4}{\# \text{ satellites in view}}$$

Example: a session whose maximum base line was 10,000 m long and only 4 satellites were in view would require an occupation time of 80 minutes.

$$80 \text{ Minutes} = \frac{10,000 \text{ m}}{125} \times \frac{4 \text{ (satellites required)}}{4 \text{ (satellites in view)}}$$

4. Logistics need to be planned, such as time needed for moves between sessions, matching the right operators for the more difficult assignments, and the efficient use of “leapfrogging” techniques.
5. Using various database forms, a final report is generated showing which operator is to occupy which station during which times. Also required is information that needs to be entered by the operator into the receiver for a pre-planned survey.
6. Field session forms, station location maps, descriptions and work assignments are distributed to the operators for completion during the sessions. All fixed height tripods, barometers and psychrometers need to be checked, calibrated if needed, and documented. Operators are responsible for checking that all equipment assigned to them is in good operating condition.

d. Instrumentation:

As with the other phases, all GPS instrumentation and data recording is performed in accordance to first order specifications set forth in the FGCC manual **Geometric Geodetic Accuracy Standards and Specifications for Using GPS Relative Positioning Techniques** (1989). Detailed instruction on the operation of the GPS receivers is not covered in this manual. The reader should refer to the owner’s manuals or contact the Geodetic Unit for “cookbook” versions. The following steps have been included to assist in eliminating possible sources of operator error:

1. Make sure you can find the correct station, even in the dark. Have the right equipment to search and recover the station, e.g., you may find the disk under one meter of snow and ice.
2. Park your vehicle far enough from and lower than the antenna over the station so it will not cause any interference.
3. If there are unstable conditions such as thawing, pound hubs into the ground for the tripod to set on.
4. Check the plumb of the antenna before and after the session. Measure the antenna height correctly and accurately in both meters and feet.
5. Take care in hooking up the antenna and power cables. Do not bend the ends of the antenna cable when rolling it back up.
6. Start GPS data collection on time and let other members of the team know when your receiver begins to collect data.
7. Check level bubble on tripod before tearing down, to ensure antenna is still plumb.

2-4.0302 Office Data Processing

The Mn/DOT Geodetic Unit processes the data associated with its first order horizontal (GPS) and 2nd Order Class I vertical control surveys according to the requirements

specified by the National Geodetic Survey. ASCII files are submitted to the NGS as per *Input Formats and Specifications for National Geodetic Survey Data Base*. The NGS incorporates this data into the national horizontal network.

The packet of material sent to the NGS for GPS projects for their review, analysis, and final adjustments contains the following project-related information:

- a. Transmittal letter.
- b. Compact Disk (CD)
- c. 3-¼ inch floppy disk.
- d. Project booklet with INDEX as in the following example:

**Minnesota Department of Transportation
First-Order GPS Control Survey
NGS REPORT**

I. CORRESPONDENCE

Project Report
Check Program Outputs (COMPGB, OBSCHK.SHT, NEWCHKOB, OBSDES, MODGEE, ELLACC)
Vector Diagram (OUTFRE.RPT, HJOBVEC.DGN, OUTORF.RPT)
Distance Measurement Comparisons

II. PLOTS

Monument Location Map (HJOBMON.DGN)
GPS Session Diagram (HJOBSES.DGN)

III. ANALYSIS AND ADJUSTMENT DATA (no printouts – see CD)

Minimally-constrained Horizontal Adjustment (HJOBOUT.FRE)
Fully-constrained Horizontal Adjustment (HJOBOUT.CO1)
Minimally-constrained Orthometric Vertical Adjustment (HJOBOUT.ORF)
Fully-constrained Orthometric Vertical Adjustment (HJOBOUT.ORB)
Minimally-constrained 3-D Adjustment (HJOBOUT.FR3)
Length Relative Accuracies (BBACCUR.OUT)

IV. DESCRIPTIONS

WDDPROC Listing (DMNHJOB.MSG, DMNHJOB.INX, & DMNHJOB.DSC)

V. ADDITIONAL OBSERVATIONS

Meteorological Logs – psychrometer & barometer

VI. ELECTRONIC DATA INFORMATION

File Name Listing including:

GPS Raw Data Files
GPS Project and Station Occupation Data File (BMNHJOB.HGZ)
GPS Vector Base Line Solution File (GMNHJOB.GEE)
Station Serial Number File (SERFIL)
WDDPROC Listing (DMNHJOB.MSG, DMNHJOB.INX, & DMNHJOB.DSC)
Check Program Outputs (COMPGB, OBSCHK.SHT, NEWCHKOB, OBSDES)

VII. GPS SESSION DATA

Daily Sessions & Schedules
Solution Summaries
Field Session Logs

The Mn/DOT Geodetic Unit retains copies of all of the above data submitted to the NGS. The pertinent Mn/DOT District Survey Section receives copies of the project's report, diagrams and the horizontal adjusted coordinate listing.

The Mn/DOT Geodetic Unit incorporates the pertinent horizontal control information into its statewide database and documents, such as the Geodetic Control Mark Index Maps (Section 2-2.0302). Appropriate updates are sent to the Mn/DOT District Survey Section and other government agencies.

2-4.04 MNDOT SECONDARY HORIZONTAL CONTROL SURVEYS (THIRD ORDER)

For a general discussion and definition of secondary control, Section 2-1.0202, "Secondary Control."

A secondary control survey is performed to extend horizontal control into areas where highway projects are proposed or planned, primary control stations are not available within a reasonable distance, where scheduling does not allow time to establish primary control.

Generally, secondary control is performed to lower standards and specifications than primary control.

2-4.0401 *Field Specifications and Records*

Secondary horizontal control surveys are permanently monumented, referenced and described according to procedures detailed in Section 2-3.05, "Horizontal Control Monuments."

The fieldwork, as for primary control surveys, involves three main phases of work: Reconnaissance, Monumentation and Instrumentation.

The reconnaissance and monumentation phases of the work are accomplished to the same standards and specifications as for primary control except that the spacing between control monuments on secondary control is from 0.8 km to 1.6 km. For detailed procedures see Section 2-4.03, "Mn/DOT Primary Horizontal Control Surveys."

The instrumentation is performed to the standards and procedures as detailed in the FGCC manual **Geometric Geodetic Accuracy Standards and Specifications for Using GPS Relative Positioning Techniques** (1989).

2-4.0402 *Mn/DOT Least-Squares Horizontal Adjustment*

There are three least-squares adjustment programs used by Mn/DOT.

The two least-squares adjustment programs used by Mn/DOT district offices are explained in **Development of a Three-Dimensional Least Squares Adjustment Program** by Professor Gerald W. Johnson of the University of Minnesota and Trimble's **GPSurvey**. The 3-D adjustment program by Professor Johnson was written to adjust data collected by "total station" instruments in Mn/DOT's SDMS (Survey Data

Management System) input and output format. The **GPSurvey** program is a Windows based program for downloading and reducing GPS baselines and running 3-D least-squares adjustments.

The program used for Mn/DOT Geodetic Unit least-squares horizontal adjustments is **ADJUST Version 4.3** (see NGS documentation at http://www.ngs.noaa.gov/PC_PROD/ADJUST/).

The **ADJUST** program is a major tool for the least squares adjustment of horizontal, vertical angle, and Global Positioning System (GPS) survey networks submitted to the National Spatial Reference System (NSRS). The authors have taken great care in using a structured, top down approach in writing the code using ANSI standard FORTRAN 77 (ANSII X3.9-1978). **ADJUST** uses up to three external input files. Two of these, BFILE and GFILE, adhere to formats defined in the Federal Geodetic Control Committee (FGCC) publication **Input Formats and Specifications of the National Geodetic Survey Data Base, volume 1, Horizontal Control Data** (2003), which is informally referred to as the “Blue Book”.

BFILE includes horizontal directions and angles, zenith distances, distances, azimuths, GPS records and survey point data (i.e., geodetic positions, geoid heights, and deflections). Another input file, named GFILE, contains GPS vectors and their standard deviations and corrections. This file need not be present if there is no GPS data in the adjustment. The third input file, AFILE, is the adjustment file. The AFILE will give the user a large variety of options and is discussed in detail in the program documentation.

Prior to using the **ADJUST** program, NGS will always run two separate programs, **CHKOBS** and **OBSDES**. Briefly, **CHKOBS** verifies the format of the Blue Book horizontal observations data according to the FGCC format specifications. **OBSDES** will modify certain Blue Book horizontal observation data record fields into a mark-to-mark form, while still maintaining valid FGCC format specifications. **OBSDES** also converts Blue Book *81* Control Point Records State Plane Coordinates (SPC) and Universal Transverse Mercator (UTM), into Blue Book *80* Control Point Records (geodetic coordinates).

2-4.05 SUPPLEMENTAL HORIZONTAL CONTROL SURVEYS

For a general discussion and definition of supplemental control, Section 2-1.0203.

Supplemental horizontal control is generally performed to meet the closure ratio of precision of no less than 1 part in 20,000. This control is established in the field to extend horizontal control on highway projects to alignment, construction, right of way, photo control points, and land corners originating off existing primary and secondary control. Supplemental control points are generally established at a higher density and on less permanent sites than are permanent control monuments.

2-4.0501 *Field Specifications and Records*

The field requirements for performance of supplemental control surveys are somewhat lower than for primary or secondary control.

The following standards and procedures apply to the field performance of supplemental horizontal control surveys:

- a. Begin and end supplemental control surveys on primary or secondary control stations.
- b. Select station sites having unobstructed lines of sight at ground level between succeeding stations.
- c. Set an iron pin and cap or square steel pipe and cap at each station site.
- d. Limit the maximum and minimum distance between control stations on the highway project to 4.8 km (3 mi) and 1.2 km (0.75 mi).
- e. Select station locations for unobstructed lines to intersected objects wherever possible, e.g., water towers, and radio masts.
- f. For starting azimuth, use another monumented control station or azimuth mark and check this azimuth by making observations to other published directions.
- g. Select station sites along roads and railroads for ease of access, permanency and recoverability.
- h. Make a layout diagram of the survey projects showing names and locations of all stations to be occupied and intersected. Show all directions to be observed and distances to be measured.
- i. Make an azimuth check and position tie every ten stations or 16 km (10 mi) of traverse (maximum) by tying to another permanent primary or secondary control.
- j. Reconnoiter supplemental control to form closed traverse loops.

Field Notes and Instrumentation:

- a. Use Form No. 21863 - "Horizontal Field Note Form" (Figure 2-4.0501A and Figure 2-4.0501B) to record all field data.
- b. Reference each station with ties and well marked reference points, and make a sketch under "REFERENCE TIES" on Form 21863.
- c. Make a sketch of the observed directions under "DIRECTIONS" on Form 21863.
- d. Record the station names, starting with the initial station, as observed in a clockwise direction from the initial station, under "TO POINT" and observed readings to stations or objects sighted under "HORIZONTAL READINGS" on Form 21863.
- e. Identify the instruments used by type and number; list the names of field personnel.
- f. Turn angles with a direction theodolite, having a least reading of 1.0 second.
- g. Observe two sets of horizontal readings to each point sighted, i.e., read to each point once direct (D), plunge and read in reverse order (R) to each point. Repeat this procedure for a 2nd set at a different initial plate setting. Initial the plate settings at $0^{\circ}0' +20''$ on the initial station and at $90^{\circ}11' +10''$ for the 2nd set.
- h. In each set, complete all observations direct (D) before reading plunged (R).
- i. Limit the spread between the direct (D) and plunged (R) horizontal readings for each point sighted to 20 seconds. Differences which exceed this specification could be an error in sighting or the instrument could be out of adjustment.
- j. Abstract the angle between the initial reading and each point sighted and record under "DIRECTIONS".

- k. Limit the divergence between directions of the two sets to 5 seconds. Make additional readings to the initial point and to all points where the divergence exceeds 5 seconds. Void rejected readings.
- l. Record the mean of sets of directions under "MEAN DIRECTIONS".
- m. Turn one set (direct and reverse) of vertical angles for each point to which a distance is measured. Record after "D" and "R". Caution! Check that the vertical index bubble is level before making vertical angle readings.
- n. Reduce the vertical angle. D & R must not differ by over 30 seconds. If greater than 30 seconds, the level should be checked and the readings repeated.
- o. Measure distances between stations with EDM instrument.
- p. Read and record temperature and determine approximate elevation to ± 30.5 m (100 ft) at each setup.
- q. Determine atmospheric correction from tables and record after "PPM Corr." on Form 21863.
- r. Read each distance once, record under "SLOPE" and cross out unit (ft or m) that does not apply.
- s. Check and initial all field notes.
- t. Make a field check of azimuth loop closure. If distributed azimuth closure exceeds 3 seconds per station, re-check notes and re-observe all angles at stations.
- u. Submit field data to office for data processing.

2-5 VERTICAL CONTROL

2-5.01 ELEVATION DATUMS

By 1900, the vertical control network in the United States had been determined along 13,000 miles of roads, rivers, railroads, and lakes. These elevations were referred to local mean sea level at five tide stations along the coasts. The elevations at these marks (bench marks) were refined as readjustments were made in 1903, 1907, and 1912. More measurements were made to accommodate development, and in 1929 a new set of elevations was determined for the United States. This new national, or general, readjustment of elevation was referred to 26 tide stations along the US and Canadian coasts. This was officially known as the “Mean Sea Level Datum of 1929.” For technical reasons the name changed in 1973 to the “National Geodetic Vertical Datum of 1929” (NGVD29). This was a change in name only and the elevation values stayed the same.

2-5.0101 National Geodetic Vertical Datum of 1929 (NGVD 29)

The National Geodetic Vertical Datum of 1929 was the national vertical datum for the 48 contiguous states from the 1929 to 1992. It was established by the National Geodetic Survey, and its use allowed separate projects to be related to each other without any direct leveling between them. The extensive leveling performed by the NGS, Mn/DOT, and U.S. Geological Survey in Minnesota allowed nearly all Mn/DOT projects to be related to the 1929 Datum with relative ease.

As precise leveling continued to be performed in Minnesota, the NGS sometimes determined that a level network readjustment in a certain area was required. This caused slightly different elevations to be assigned to some vertical control marks. Different and more accurate elevations for old bench marks were usually determined wherever more precise leveling methods were employed when releveling an old level line. These factors caused many benchmarks to have slightly different elevations recorded at different times. As such, whenever an elevation is assigned to a bench mark, the date and file reference of the vertical publication from which the elevation was taken should also be listed.

2-5.0102 North American Vertical Datum of 1988 (NAVD 88)

By the 1980s, technical advancements and denser development demanded a review of the changes in the U.S. system of elevations - the vertical datum. Out of this review, changes were proposed. With subsequent technical review, changes were made and the results became known as the “North American Vertical Datum of 1988” (NAVD 88).

With technological developments in our ability to measure the Earth, the need to refer to tidal stations was eliminated. All elevations in the United States and Canada now refer to a single benchmark, Father Point/Rimouski, located at the mouth of the St. Lawrence River.

The U.S. Federal Government affirmed the NAVD 88 as the “official civilian vertical datum for surveying and mapping activities in the United States performed or financed by the Federal Government...” (Federal Register, Vol. 58, No. 120/ Thursday, June 24, 1993/ Notices).

In June 1995, the Mn/DOT Surveys Organization decided that NAVD 88 would be the vertical datum used for all new surveying and mapping projects.

Reasons for having a readjustment of the National Vertical Datum include the following:

- a. The previous adjustment (NGVD 29) was warped to fit the tidal benchmarks on both coast lines.
- b. The new geoid (sea level) is based on a better model and the new datum (NAVD 88) is based on one benchmark and not forced to fit sea level at both coast lines (sea level at Los Angeles is not the same elevation as sea level in New York).
- c. There were errors in the old leveling network and 60 years of additional leveling data and better equipment, techniques, etc. led to the decision to readjust the vertical datum. (Figure 2-5.0102).
- d. The new datum will increase the accuracy of GPS derived elevations.

The published NAVD 88 elevations for 15,000 first and second order vertical control marks in Minnesota were received from the National Geodetic Survey in November 1991. These elevations were then placed in the Mn/DOT Geodetic Database. There are currently 23, 540 first and second order elevations in Minnesota and 8637 third order elevations.

2-5.02 NETWORK DESCRIPTIONS

The first, second, and third order level nets in Minnesota were established within certain guidelines.

The first order leveling lines are placed so that eventually no point will be more than 80 km (50 mi) from a first order benchmark. The second order leveling lines subdivide the first order leveling until no point will be more than 20 km (12.5 mi) from a first or second order bench mark. Third order leveling lines may subdivide first and second order leveling, but they must not extend more than 48 km (30 mi) from the higher order lines. Third order lines must always be loops or circuits and close upon lines of equal or higher order.

2-5.03 MN/DOT PRIMARY VERTICAL CONTROL SURVEYS (NGS PUBLISHED)

For a general discussion of Mn/DOT primary control surveys refer to Section 2-1.0201 in this manual.

The three main objectives of primary vertical control surveys are:

- a. Provide networks of permanent primary control so that no location within a given area is more than 20 km (12.5 mi) from a primary control point.
- b. Provide maintenance and releveling of old lines for preservation and updating the reliability of elevations.
- c. Provide second order vertical control on highway projects with permanent monuments set at 0.8 km (0.5 mi) to 1.6 km (1 mi) intervals.

The National Geodetic Survey's Geodetic Leveling Division has the primary responsibility for the first two objectives. The Mn/DOT Geodetic Unit has the primary responsibility for the third objective.

The second order Mn/DOT vertical control surveys submitted to the NGS for publication are performed to the Standards and Specifications for Second-Order Vertical, Class I, as detailed in the Federal Geodetic Control Committee's bulletins **Standards and Specifications for Geodetic Control Networks**, September 1984 (Reprinted 1991), and **FGCS Specifications and Procedures to Incorporate Electronic Digital/Bar-code Leveling Systems**, May 2004.

2-5.0301 *Field Specifications and Records*

In October 1993, the Geodetic Unit made the transition from a four-person level crew using optical instruments to a three-person crew using an electronic digital bar code system. The instrument person no longer needs to read the numbers from the rod. Instead, the numbers are read automatically by the instrument and stored on a card, which is later downloaded to a computer for processing. Although most of the field procedures remained unchanged, this section will discuss the leveling process used since 1993.

The three main phases of field work involved in the performance of primary vertical control surveys are: Reconnaissance, Monumentation, and Instrumentation. A summary of the three phases is as follows:

a. **Reconnaissance:**

The reconnaissance phase of a vertical project is similar to that of a horizontal project (Section 2-4.0301). The first step is to recover existing vertical control on both ends of the project. The existing control must have an accuracy order equal to or better than the order of the new survey and elevations on the correct vertical datum for the new project. NGS specifications for second order - class I leveling require a minimum of four control bench mark ties, two at each end, with no more than 50 km between the ends. Any additional network control within 3 km of the survey needs to be recovered and leveled to, except where parallel lines exist, in which case refer to an NGS table. As time and weather permit, any additional control not leveled to in the project should also be recovered in order to keep the Mn/DOT Geodetic Database current. Each mark recovered must have all old ties checked for accuracy and new information added. See Section 2-3.06 for instructions. If possible, any previously scaled horizontal positions of recovered monuments should be improved using various differential GPS methods. The method used should be recorded so the accuracy can be noted. These new positions will aid future users in navigating to the mark using GPS equipment, which will be especially helpful if any or all of the local ties are destroyed.

Any existing control monuments used that are not listed in the Mn/DOT Geodetic Database, such as reference marks (RMs) or azimuth marks, need to be fully described according to instructions in Section 2-3.0601.

The second phase of reconnaissance is to select sites for new benchmarks according to NGS specifications. In making a selection, use any existing permanent control marks that were not previously positioned vertically to standards needed for the new survey, e.g., a horizontal control station.

NGS specifications require consideration of spacing, stability, permanence, and availability of local reference ties to aid in describing and recovering the mark. Also, with the advent of the Geodetic 3-D monument (Section 2-3.02), it is imperative to choose a site with no overhead obstructions. Second order leveling

requires permanent monuments spaced at no more than 3 km, and no more than 1.6 km average interval spacing. Mn/DOT policy calls for permanent monuments at 1.6 km intervals. This 1.6 km space can be plus or minus about 0.3 km when necessary. In some areas, for engineering or other reasons, 0.8 km intervals may be preferable. Often, it will be difficult to decide what is the best location for a mark at a given place along a line of levels. The specifications for spacing benchmarks sometimes require their construction in places where ideal conditions are not obtainable. In general, however, it is well to avoid steep banks or hillsides where sliding may disturb the mark in elevation. Close proximity to the banks of streams should also be avoided to reduce the danger of undercutting the mark. If placing marks along railroads or highways, stagger them on one side and then on the other side. "Staggering" will insure no single widening or double-tracking project will take out a whole row of benchmarks at one time.

During the reconnaissance of the project, all suitable sites for disks should be noted. Sites such as bedrock, bridges, and buildings are not only more economical as a monument but are also often more stable than rod type monuments. After considering all site possibilities, the sites for setting concrete-or rod-type disks can be selected and marked with a lath to fulfill the 1.6 km spacing requirements of the project.

All concrete structures such as bridges, dams, and box culverts should be carefully searched for existing survey marks. Occasionally, disks have been set and not recorded by the agency that set the mark. Box culverts would be the least desirable sites for installing benchmarks due to their instability.

After the site selections have been completed on a project, the mark designations must be made. The Mn/DOT Geodetic Unit assigns the designations after researching its records and files to make certain there is no duplication of mark designations.

A standard series of numbers and letters have been established for Mn/DOT vertical control mark designations. The four state project (S.P.) numbers identify the county and control section of highway.

The letter (or letters) is in alphabetical progression from one monument to another. The progression is not necessarily in any particular direction but would normally begin at one end of the project and continue alphabetically through the appropriate S.P. number in the direction of the stationing. The letters are assigned to the mark beginning with "A" (e.g., 2780 A) and continuing through the alphabet, omitting letters "I" and "O" to avoid confusion with the numbers one and zero.

If additional designations are needed in the same S.P., the alphabetical sequence continues with the letter "A" as a constant and the letters "A" through "Z" (e.g., 2780 AA, 2780 AB etc.) added in order, again omitting letters "I" and "O." The alphabetical progression of the letter constant can continue as far as necessary.

In case of a spur line, use the designation of the BM closest to the beginning of the spur and add numbers 1-2-3-4, etc., as needed (2780 A1, 2780 A2).

b. Monumentation:

After the reconnaissance survey has been completed and all nearby utilities located, the monumentation work is performed according to detailed instructions given in Section 2-3.02, "Three-Dimensional Monuments," and Section 2-3.04, "Vertical Control Marks." For new marks, all disks must be stamped according to the assigned designation prior to installing in or on the monument. All questions relating to stamping on new or old disks should be referred to the Mn/DOT Geodetic Unit. The date of the establishing of the monument is to be stamped at the lower center of the disk. If an unstamped Mn/DOT disk is found and no record of its being used is available, the disk is to be treated as a new mark and so designated using the current date.

Under no circumstances will the elevation of the mark be stamped onto the disk, as this elevation is subject to change.

c. Instrumentation:

The standards and specifications for making the field measurements required on primary vertical control surveys are those of the NGS and the Federal Geodetic Control Committee. Complete copies of this information are available from the Mn/DOT Geodetic Unit upon request. In October 1993, the Geodetic Unit began to use an electronic digital level and bar-coded rods for second order leveling following specifications set forth in the NGS publication **FGCS Specifications and Procedures to Incorporate Electronic Digital/Bar-code Leveling Systems**, May 2004. Another NGS guide alluded to in numbers 21 and 23 below is titled **NA3003 Digital Leveling User's Guide**. Due to limited space and ongoing revisions to the instruments and software, only basic instrumentation requirements are given. If the reader desires detailed instruction on instrument operation and field procedures, contact the Mn/DOT Geodetic Unit.

1. Begin and end second order control level circuits on previously established bench marks of equal or higher order of precision. Use two existing benchmarks at each end of the new level circuit to establish starting and ending elevations. These monument elevations must satisfy the accuracy requirements of the original leveling; if not, use additional existing monuments to determine a satisfactory starting elevation. A leveling section is defined as a run between two permanent or supplementary benchmarks on a new level circuit.
2. Use only instruments and equipment approved by the NGS. Bar coded rods must be certified and manufacturer's calibration data must be furnished to the NGS in digital format.
3. At the beginning of each day, a collimation error must be determined using the one-third, two-thirds (15m) peg test procedure or using the Forstner Method. The error, which is not to exceed $0.5 \text{ mm/m} = 10 \text{ arc seconds}$, is stored digitally and used to correct each subsequent rod reading for that day.
4. Check the bull's-eye rod level at regular intervals (at least every two weeks) and adjust if the deviation from the vertical exceeds 10 mm per 3 meters of rod length.
5. Read and record the upper and lower temperature probes at each setup.

6. Suspend leveling when the wind velocity exceeds 32 km/h (20 mph).
7. Carry the instrument in a near upright position between setups.
8. Step the tripod into the ground and allow it to settle for 20 seconds before taking a reading.
9. The same rod, either A or B, should be read first at each setup during any one day to permit partial compensation of any systematic settling of an instrument, such as in soft or frozen ground. To minimize stand by time intervals, when "B" is the foresight, "A" should not be read until "B" is in position.
10. Plumb rods before each reading with a bull's-eye level held or fastened to the rods.
11. Make all turns on a 15 to 30 cm (6 to 12 in) pin driven vertically into the ground or on a turning plate set on stable ground. Avoid setting the turning plates on bituminous surfaces to minimize settlement during hot days.
12. Limit the lengths of backsights and foresights to 60 m maximum under normal viewing conditions and 50 m or less if heat waves are excessive.
13. Balance backsights and foresights to within 5 m at each setup and 10 m per section.
14. Take readings no lower than 0.5 m above the ground and at or near right angles to road crossings.
15. Use reciprocal leveling procedures where unbalanced sights are necessary, e.g., at river crossings more than 60 m wide.
16. Double run all lines for second-order, class I projects and single run all lines for second-order, class II projects.
17. Run about 50% of each leveling circuit in opposite directions.
18. Make forward and backward runs at different times of day.
19. Limit the variation between forward and backward running of a leveling section to $6\text{mm}\sqrt{K}$ (class I) and $8\text{mm}\sqrt{K}$ (class II) where K is the shortest one-way length of section in kilometers.
20. Maximum loop error of closure is also $6\text{mm}\sqrt{K}$ (class I) and $8\text{mm}\sqrt{K}$ (class II).
21. Use the multiple reading option to obtain each observation (rod reading), with a minimum of three readings having a standard deviation of 0.1 mm or less.
22. The Modified Double Simultaneous (MDS) observing sequence must be used. Also known as the BFFB method, this sequence is as follows:
 - a. backsight
 - b. backsight distance, standard error met
 - c. foresight
 - d. foresight distance, standard error met
 - e. off-level/relevel
 - f. foresight, standard error met
 - g. backsight, standard error met

23. A reading check of 0.6 mm must be met between the BS FS difference of elevation (Δh_1) minus the FS BS difference of elevation (Δh_2) for each setup.
24. At the end of a day, leave one section open (run only one way) between two permanent bench marks for an overlap (check) when leveling is resumed.
25. Record field abstract level notes on Form NOAA 76-187 "Geodetic Leveling Field Abstract" (Figure 2-5.0301).
26. General Requirements:

In some cases, the point on which an elevation has been, or will be, established cannot be used with a ten-foot level rod. A short section of a precise level rod can be employed, but the reading should be taken as close to the zero end as possible.

A disk may be set vertically (shaft horizontal) in a wall or similar structure. In this case, both rod persons should assist in the measurement. One person will hold the rod base or zero mark on the horizontal line in the center of the disk while the other rod person steadies the rod in a plumb position. A measured block of some type may be necessary to level to the bottom of a chiseled hole or a disk with a concave surface, and it must be used on both bench marks on either end of the section in order to "cancel out" the block.

If unbalanced sights cannot be avoided, the error should be compensated for as soon as possible. The next setup can be unbalanced in the opposite direction. If the unbalanced sight is a one setup measurement, an unbalanced sight from the opposite direction under or as close to identical atmospheric conditions as possible is required. An example of this condition would be at a river crossing.

Second Order Class I leveling requires at least one forward and one backward difference between consecutive marks. These differences must be in agreement by plus or minus 6 mm times the square root of the shortest distance in kilometers ($\pm 6\text{mm} \times \sqrt{K}$). Two forward or two backwards runs are not acceptable without at least one run in the opposite direction. These conditions must be met after any rejections that might be required.

27. After the field work is completed, electronic data files are transferred and processed, descriptions and recovery notes completed, and the field report is written, the project folder is submitted to the Geodetic Services Surveyor or Engineering Specialist for further office data processing.

2-5.0302 Collimation Constant, "C"

The collimation constant, "C," represents the inclination of a line of sight of a level from the true horizontal. "C" is a ratio of vertical length to horizontal length and is therefore dimensionless. However, like slope measurement, it is expressed in terms of length/length, e.g., meter/meter, meter/100 meter, ft/ft, ft/100 ft, etc. The units m/m are 100 times greater than those of m/100 m, and as such, the ratio of units must always be stated for "C."

The collimation constant, "C," is determined by the two-peg test (Forstner Method) as shown in Figure 2-5.0302. This consists of a short, closed leveling circuit that exaggerates the difference between backsight and foresight distances, producing a closure proportional to the collimation of the level. Two turning points, A and B, are set about 45 meters apart, and the instrument is set at position 1 on line AB, about 15 meters in from point A. Then r_1 and R_1 are read on the near rod, and far rod respectively. The

level is then moved to position 2 on AB, about 15 meters in from point B. Again, the near and far rods at B and A, respectively, are read as r_2 and R_2 . The horizontal distances d_1 , D_1 , d_2 , and D_2 are recorded after taping them or after determining them by stadia.

The "C & R correction" is the curvature and refraction correction that must be applied to long sights like R_1 and R_2 . It is insignificant on short sights. Various equations are given below for the "C & R correction:"

$$C \ \& \ R \ (\text{meters}) = 6.75 \times 10^{-8} \ (\text{m})^2$$

$$C \ \& \ R \ (\text{feet}) = 0.574 \ (\text{mi})^2$$

$$C \ \& \ R \ (\text{feet}) = 2.06 \times 10^{-8} \ (\text{ft})^2$$

Where the (distances)² are D_1 or D_2 from Figure 2-5.0302.

Positive "C" means the line of sight is inclined down from horizontal. Negative "C" means the line of sight is inclined up from horizontal.

Example: In Figure 2-5.0302 calculate "C" for the following data:

$$\begin{aligned} d_1 &= 7.6 \text{ m} & r_1 &= 1.5653 \text{ m} \\ D_1 &= 68.8 \text{ m} & R_1 &= 1.2827 \text{ m} \\ d_2 &= 7.7 \text{ m} & r_2 &= 1.3977 \text{ m} \\ D_2 &= 68.9 \text{ m} & R_2 &= 1.6823 \text{ m} \end{aligned}$$

Therefore:

$$C \ \& \ R \ @ \ R_1 = (6.75 \times 10^{-8}) (68.8)^2 = 0.0003 \text{ m. and}$$

$$C \ \& \ R \ @ \ R_2 = (6.75 \times 10^{-8}) (68.9)^2 = 0.0003 \text{ m.}$$

$$R_1 \text{ cor.} = 1.2827 - 0.0003 = 1.2824 \text{ m}$$

$$R_2 \text{ cor.} = 1.6823 - 0.0003 = 1.6820 \text{ m}$$

$$"C" = \frac{(r_1 + r_2) - (R_1 \text{ cor.} + R_2 \text{ cor.})}{(D_1 + D_2) - (d_1 + d_2)}$$

$$"C" = \frac{(1.5653 + 1.3977) - (1.2824 + 1.6820)}{(68.8 + 68.9) - (7.6 + 7.7)} \quad "C" = +0.00001 \text{ m/m, or}$$

"C" = +0.001 meter/100 meters inclined down.

In this case, the instrument is in adjustment since the magnitude (absolute value) of "C" is less than 0.00005 or 0.005/100.

Level Adjustment

If the collimation constant, "C," exceeds 0.00005 or 0.005/100, the instrument must be adjusted after which the collimation test must be repeated. The line of sight of the level is adjusted by the procedures outlined in the operator's manual for the type of level used.

2-5.0303 *Office Data Processing*

The Mn/DOT Geodetic Unit processes the data associated with its Second Order Class I vertical control surveys according to the requirements specified by the NGS. The NGS is the ultimate recipient of the data and incorporates it into the national vertical network.

As of 1999, the packet of material submitted to the NGS for their review, analysis, and final adjustments contain the following project-related information:

- a. Transmittal Letter
- b. 3 1/4 inch floppy disk
- c. Project booklet with INDEX as in the following example:

**Minnesota Department of Transportation
2nd-Order Class I Vertical Control Survey
NGS REPORT**

- I. Project Report and Project Diagrams**
 - NGS map of Control Leveling (Project Area)
 - Control Diagram (VxxxxCON.DGN)
 - Network Diagram (VxxxxNET.DGN)
 - Monument Location Diagram (VxxxxMON.DGN)
 - Leveling Sequence Diagram (VxxxxSEQ.VSD – Visio Pro)
- II. MNDT Preliminary Bench Mark Listing (VxxxxCON.PBT)**
- III. NAVD 88 Datum Analysis and Adjustment**
 - Station File (VxxxxS)
 - Closure Analysis (CLOS.DAT)
 - Comparative Analysis (COMPAR.DAT)
 - Abstra output file (Vxxxx.ABS)
- IV. STAR*LEV Adjustments**
 - FREE ADJUSTMENT (STAR*LEV ADJUSTMENT PROGRAM) (VXXXXFRE.LST)**
 - Summary of files used
 - Summary of options used
 - Summary of all unadjusted input observations
 - Number of differences in elevation
 - Adjustment results
 - Statistical summary
 - Adjusted elevation difference observations and residuals
 - Error propagation
 - FULLY CONSTRAINED ADJUSTMENT (STAR*LEV ADJUSTMENT PROGRAM) (VXXXXALL.LST)**
 - Summary of files used
 - Summary of options used
 - Summary of all unadjusted input observations
 - Number of differences in elevation
 - Adjustment results
 - Statistical summary
 - Adjusted elevation difference observations and residuals
 - Error propagation
 - FINAL CONSTRAINED ADJUSTMENT (STAR*LEV ADJUSTMENT**

PROGRAM) (VXXXXCON.LST)

Summary of files used
 Summary of options used
 Summary of all unadjusted input observations
 Number of differences in elevation
 Adjustment results
 Statistical summary
 Adjusted elevation difference observations and residuals
 Error propagation

V. FILE PRINTOUTS

WDDPROC Index (DMNVxxxx.INX)
 WDDPROC Message File (DMNVxxxx.MSG)
 WDDPROC Description File (DMNVxxxx.DSC)
 List of VERTOBS file for NGS I.D.B. (Vxxxx.ASC)
 Summary of Field Data (Vxxxx.SUM)
 Field Book File (Vxxxx.BOK)

The Mn/DOT Geodetic Unit retains hard copies of all of the above data except the raw data file and field notebook listing. The Geodetic Unit backs up all input, output and map files on floppy disk and/or the DOT-LM network server. The pertinent Mn/DOT District Survey Section receives copies of the project's report, diagrams, and Mn/DOT preliminary bench mark tabulation.

The Mn/DOT Geodetic Unit incorporates the pertinent information into its statewide database. Documents such as the Geodetic Control Mark Index Maps (Section 2-2.0302), are updated and sent to the Mn/DOT District Survey Unit and other interested government agencies.

2-5.04 MN/DOT SECONDARY VERTICAL CONTROL SURVEYS

For a general discussion and definition of secondary control see Section 2-1.0202, "Secondary Control."

Secondary vertical control surveys are used to provide project bench marks along planned or proposed highway projects where existing primary control marks are not available, existing marks are not convenient to the project, or the construction schedule does not permit enough lead time to run the more precise primary control.

Secondary control is generally performed to meet third order standards as specified in Federal Geodetic Control Committees bulletin **Classification, Standards of Accuracy, and General Specifications of Geodetic Control Surveys and NGS' Manual of Geodetic Leveling**.

2-5.0401 Field Specifications and Records

Standard equipment: The field equipment recommended for performance of secondary vertical control surveys consists of:

Level: Trimble/Zeiss Dini 11 or Dini 12 Digital Level

Tripod: Fixed Leg

Rod: Trimble/Zeiss Bar Coded Rods

Note Form: "Control Leveling - Three Wire" Mn/DOT Standard Form No. 21857 (Figure 2-5.0401).

The three main phases of field work involved in the performance of secondary vertical control surveys are reconnaissance, monumentation and instrumentation.

a. Reconnaissance and Monumentation

In general, reconnaissance and monumentation are two phases of secondary vertical control performed to the same standards and specifications as primary control. See detailed requirements in Section 2-5.0301, "Field Specifications and Records," and Section 2-3.04, "Vertical Control Marks."

b. Instrumentation

The instrumentation phase of secondary vertical control is performed to standards and specifications that are similar to primary control, differing mainly in type of equipment, note form used, rod reading procedure, number of runs per level circuit, allowable sight distance, starting bench marks and length of section between line closure. The following standards and procedures have been abstracted from the NGS **Manual of Geodetic Leveling** and Federal Geodetic Control Committee bulletin **Classification, Standards of Accuracy, and General Specifications of Geodetic Control Surveys**:

1. Begin and end third order control level circuits on previously established bench marks of equal or higher order of precision. Use two existing bench marks at each end of the new level circuit to establish starting and ending elevations. The monument elevations must satisfy the accuracy requirements of the original leveling; if not, use additional existing monuments to determine a satisfactory starting elevation.
2. Record all rod readings on Mn/DOT Standard Form No. 21857 "Control Leveling - Three Wire" (Figure. 2-5.0401).
3. Check the stadia constant for each new instrument.
4. Make a two-peg test each day to determine the collimation constant "C" (Section 2-5.0302). If "C" exceeds ± 0.00005 m/m, adjust the instrument and determine a new, acceptable "C" before proceeding with leveling.
5. Check the bull's-eye rod levels at regular intervals and adjust if the deviation from vertical exceeds 10 mm per 3 m of rod length.
6. Read and record the rod thermometers at the beginning of each section of leveling, and at least three times daily.
7. Suspend leveling when the wind velocity exceeds 32 km/h (20 mph).
8. Carry the instrument in a near upright position between setups.
9. Step the tripod into the ground and allow it to settle for 20 seconds before taking a reading.

10. Use of a sun shade over the instrument on sunny days is recommended when checking first-order bench marks and is optional when checking second-order leveling.
11. Level the instrument before taking each rod reading.
12. Plumb the rod before each reading with a bull's-eye level held or fastened to the rod.
13. Make all turns on a 15 to 30 cm (6 to 12 inch) pin driven vertically into the ground or on a turning plate set on stable ground.
14. Limit the lengths of backsights and foresights to 75 m (250 ft) under normal viewing conditions and to 50 m (165 ft) if heat waves are excessive.
15. Balance backsights and foresights by stadia to within 10 m (30 ft) at each setup.
16. Limit the difference between accumulated stadia lengths of backsights and foresights to 20 m (60 ft) for each section of leveling.
17. Delay backsight reading until the foresight rod is ready to read; make both readings in the shortest possible time.
18. Take readings no lower than 0.5 m (1.5 ft) above the ground and at or near right angles to road crossings.
19. Read the front side of the rod on the three cross wires to 1.0 mm and record under "Thread/Readings."
20. Repeat the readings if the upper and middle thread interval does not agree with the lower and middle thread interval within 3.0 mm.
21. Read the backside of the rod on the center cross wire to 0.01 ft. Record under "Middle Thread."
22. Repeat the reading if the "Mean/Meter" value differs from backside rod reading by 6 mm.
23. Make recordings in ink with corrections entered above crossed-out void recordings.
24. Use reciprocal leveling procedures where unbalanced sights are necessary (Section 2-5.0402) e.g., at river crossings more than 75 m wide.
25. Run about 50% of each leveling circuit from opposite directions.
26. Make a double run if the single run circuit closure is not within required limits.
27. Make forward and backward runs at different times of day.
28. Limit the variation between forward and backward running of a leveling section to 12.0 mm
29. Set a check point at the end of a leveling section when leveling is temporarily suspended on a permanent or supplemental bench mark. Set the check point at least 0.3 m (1 ft) higher and at a distance of one normal setup away from the benchmark. Level through the benchmark and suspend levels on the check point. Resume leveling on the check point and run through the permanent bench mark.

If the variation between previous leveling is more than 1 mm, relevel the entire section from the last benchmark.

30. Set two check points when leveling is temporarily interrupted at a point on a section between permanent bench marks, following procedures as stated above in number 29. Designate check point 2 as the ending point when suspending leveling and the starting point when resuming leveling.
31. Write a field description report for each permanent bench mark (new or recovered) according to instructions in Section 2-3.06.
32. Make recovery reports of all Mn/DOT permanent bench marks according to instructions detailed in Section 2-3.07 and set witness posts at marks where there are none.
33. Check and initial all field notes.
34. Complete "Geodetic Leveling Field Abstract" Form No. NOAA 76-187 (Figure 2-5.0301).
35. Make a computation for circuit closure.
36. Submit the survey report, abstract of leveling, circuit closure adjustment, original recovery and description information to the Geodetic Unit.

2-5.0402 *Reciprocal Leveling*

Reciprocal leveling procedures are required for leveling across rivers or depressions where unbalanced sights are necessary and the sight distance exceeds 60 m (200 ft). The following procedures are used for reciprocal leveling:

1. Establish two turning points (TBMs) "A" and "B" on opposite sides of the river or depression to be leveled over, at nearly the same elevation and at least 3m (10 ft) above the water surface (Figure 2-5.0402).
2. Extend the levels to turning point "A" by normal leveling procedure.
3. Set up the level near Point "A" and read a backsight (r1) on Point "A" and a foresight (R1) on Point "B" using normal leveling procedures.
4. Enter the notation "Reciprocal Leveling," under last entry on note form and record readings below notation.
5. Set up the level near Point "B" and read a backsight (r2) on Point "B" and foresight (R2) on Point "A"; record after "B" entry.
6. Determine the mean of level readings, backsights, and foresights between Points "A" and "B" and continue leveling with normal procedures.

2-5.05 SUPPLEMENTAL VERTICAL CONTROL SURVEYS

For a general discussion and definition of supplemental control, see Section 2-1.0203.

Supplemental vertical control is established in the field to provide vertical datum elevations required for preliminary engineering, photo control and construction surveys. This leveling originates from primary and secondary control and is performed to considerably lower requirements than those for primary or secondary control. For example, leveling to obtain photo control elevations requires closed loop circuits to all picture points with an allowable elevation deviation of up to 1/10 the contour interval (C.I.) (i.e., for a one foot C.I. allowable deviation is ± 0.1

foot). See detailed specifications and tolerances in Chapter 4, "Photogrammetric Surveys", Chapter 5, "Location Surveys", and Chapter 6, "Construction Surveys".

2-5.0501 *Field Specifications and Records*

The field equipment needs will vary depending on the type of and accuracy requirements of the work to be performed. Generally:

1. For closed loop leveling or construction stake out, use an automatic or digital level with Philadelphia or bar-coded rod, or a total station instrument with plumbing pole mounted retro prisms.
2. For unspecified tolerance engineering or construction elevations, use a transit or hand level, tape and stadia rod.
3. Note form: standard loose leaf, ruled, three ring level note paper and loose leaf binder unless a special form is specified (Figure 2-5.0501).

Field Requirements and procedures for supplemental control leveling (closed loop):

1. Check rod daily for correct extended length. The length should not deviate more than 6 mm (0.02 ft) from the correct length, as measured with a steel tape.
2. When using rods in pairs, the high rod lengths should not differ by more than 6 mm (0.02 ft) or another pair should be used.
3. Plumb or rock rods for all readings.
4. Make a two-peg test at least weekly before leveling. See detailed requirements in Section 2-5.0302. If "C" exceeds ± 0.00005 m/m, adjust the instrument.
5. Begin and end levels on primary or secondary bench marks.
6. Balance the lengths of foresights and backsights by pacing and judgment.
7. Use reciprocal methods where greatly unbalanced sights are necessary (see Section 2-5.0402), or apply corrections for curvature and refraction and collimation error to unbalanced sights.
8. Number and date all pages, and read and record rod readings and elevations on turning points and bench marks to 5 mm (0.01 ft).
9. Record recoverable turning points as TBMs or UEs and describe on field note form (Figure 2-5.05). No permanent descriptions, bench mark tabulation or recovery reports are required on these points.
10. Whenever feasible, begin and end each level loop on different bench marks to increase accuracy and reliability.
11. Write recovery reports on all primary and secondary marks recovered or used on appropriate standard recovery note form (Section 2-3.07).
12. Field check, initial and date all notes and turn into office for data processing.

2-5.06 FUTURE OF VERTICAL CONTROL

It has been proven, in areas where the geoid model has been improved, that GPS methods can be used to obtain mean sea level elevations with centimeter accuracies. To obtain this level of accuracy, the geoid model needs to be consistently improved throughout Minnesota through additional GPS, leveling, and gravity observations.

The National Geodetic Survey's Height Modernization Program shows great promise in making GPS derived vertical observations more accurate. For additional information see:

<http://www.ngs.noaa.gov/heightmod/index.shtml>

2-6 THE GLOBAL POSITIONING SYSTEM

2-6.01 INTRODUCTION

The Global Positioning System (GPS) has so revolutionized the practice of Geodetic Surveying that special mention of it is made here. GPS is a radio-navigation system with a constellation of over 24 satellites that act as “man-made stars” allowing users to position themselves very accurately. It was created by the Department of Defense for military purposes. Congress funded it so that it could be used for civilian purposes. Depending on the type of equipment, the potential accuracy ranges from tens of meters to less than a centimeter.

The effect on geodetic surveying has been staggering. Prior to GPS, geodetic surveying was limited to measurements that were accurate to 1:1 million, achievable only with formidable effort. With today’s advanced techniques and equipment, measurements can exceed 1:1 billion. The very coding system for geodetic projects had to be modified due to this ability.

Other impacts on geodetic surveying will be felt in the near future. A more accurate datum will be released in the next couple of years by the National Geodetic Survey; to be called the International Terrestrial Reference Frame (ITRF). It will be made possible in part due to a better understanding of the center of mass of the earth. The continual collection of data from the GPS satellites has contributed to this knowledge.

A booklet entitled the GPS Positioning Guide (July 1993, second printing January 1995) was put together by the Geodetic Survey Division of Geomatics Canada, Natural Resources Canada. It can be downloaded or purchased at: <http://www.geod.nrcan.gc.ca/>.

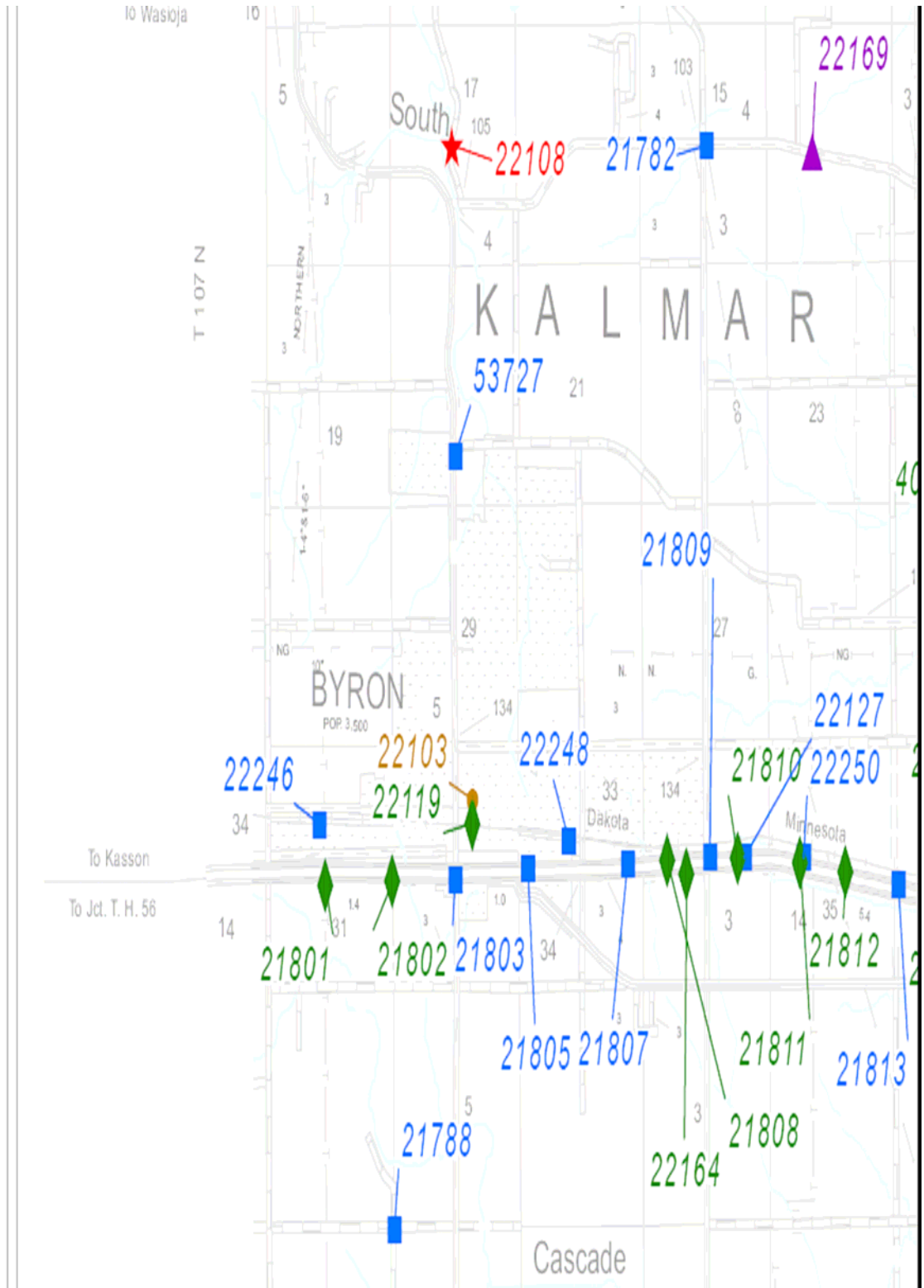

FIGURE 2-2.0301A MN/DOT GEODETIC CONTROL MARK INDEX MAP

Geodetic Marks

by type:

- ★ *HARN (A- or B-order only)*
- ◆ *3-D (H/V dimensions of any order)*
- *Vertical (1st-order or less)*
- ▲ *Horizontal (C-order or less)*
- *Un-positioned (No Dimensions)*

GS ID	Station Name	Stamping	H Or	ACRN	V Ord	Set Date	Reco Dat	Cond	Mon - Disk
21776	1 DRL	1 DRL 1972			3	4/1972	4/1972	G	BH - Z
21777	1026	1026			3	4/1934	4/1934	G	CM - Z
21778	2 DRL	2 DRL 1972			3	4/1972	4/1972	G	CUL - Z
21779	28 GJS	28 GJS 1964 985		PP0331	2	4/1964	6/2001	X	CM - Z
21780	3 DRL	3 DRL 1972			3	4/1972	4/1972	G	CUL - Z
21781	3-001	3-001 1972		PP0343	2	4/1972	4/1972	G	BA - DD
21782	31 GJS	31 GJS 1964 1222			3	4/1964	4/1964	G	CM - Z
21783	32 GJS	32 GJS 1964 1276			3	4/1964	4/1964	G	CM - Z
21784	33 GJS	33 GJS 1964 1935			3	4/1964	12/2004	X	CM - Z
21785	35 GJS	35 GJS 1964 1082			3	4/1964	4/1964	G	CM - Z
21786	37 GJS	37 GJS 1964 1037			3	4/1964	4/1964	G	CM - Z
21787	37 RDS	37 RDS 1953			3	4/1953	4/1953	G	HBC - Z
21788	38 GJS	38 GJS 1964 1215			3	4/1964	4/1964	G	CM - Z
21789	38 RDS	38 RDS 1953			3	4/1953	4/1953	G	CM - Z
21790	4 DRL	4 DRL 1972			3	4/1972	4/1972	G	HBC - Z
21791	40 RDS	40 RDS 1953			3	4/1953	4/1974	P	CM - Z
21792	41 RDS	41 RDS 1953			3	4/1953	4/1953	G	CM - Z
21793	48 RDS	48 RDS 1953			3	4/1953	4/1953	G	CM - Z

FIGURE 2-2.0301B MN/DOT GEODETIC CONTROL MARK INDEX MAP LEGEND

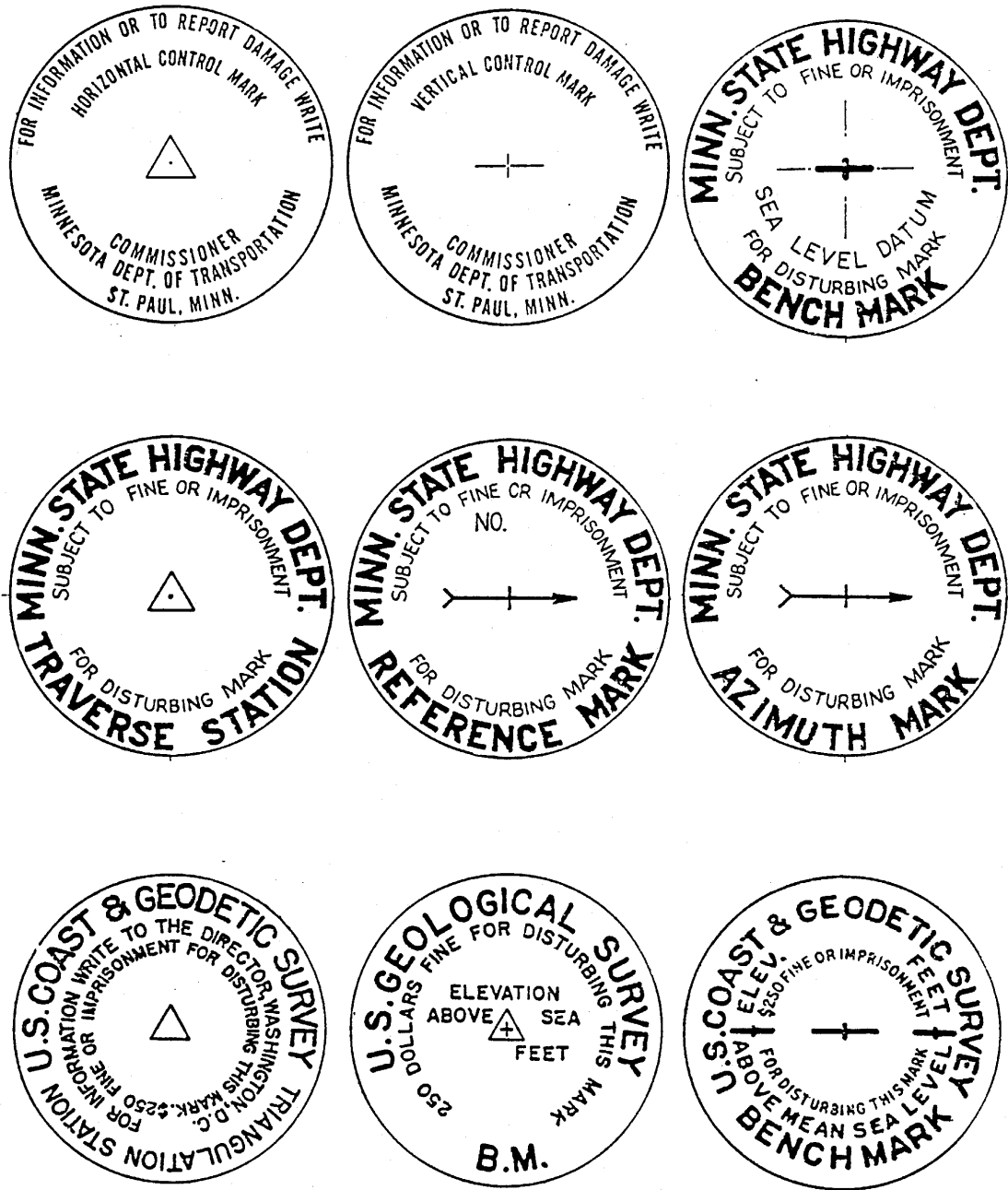

GEODETIC SURVEY DISKS

Figure 2-3.01 Diagram of Simplest Datum

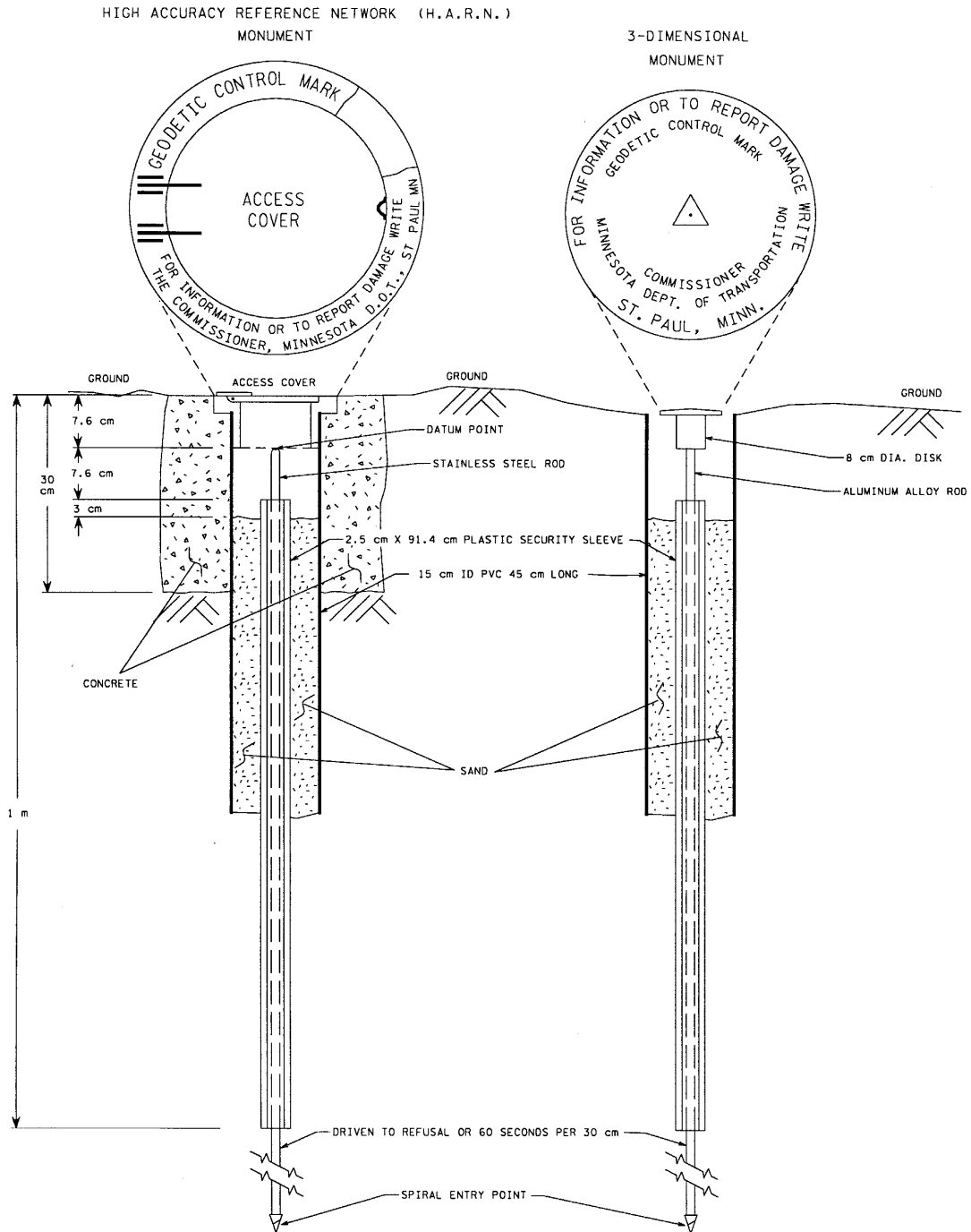

Figure 2-3.02 Rod Type Mounment

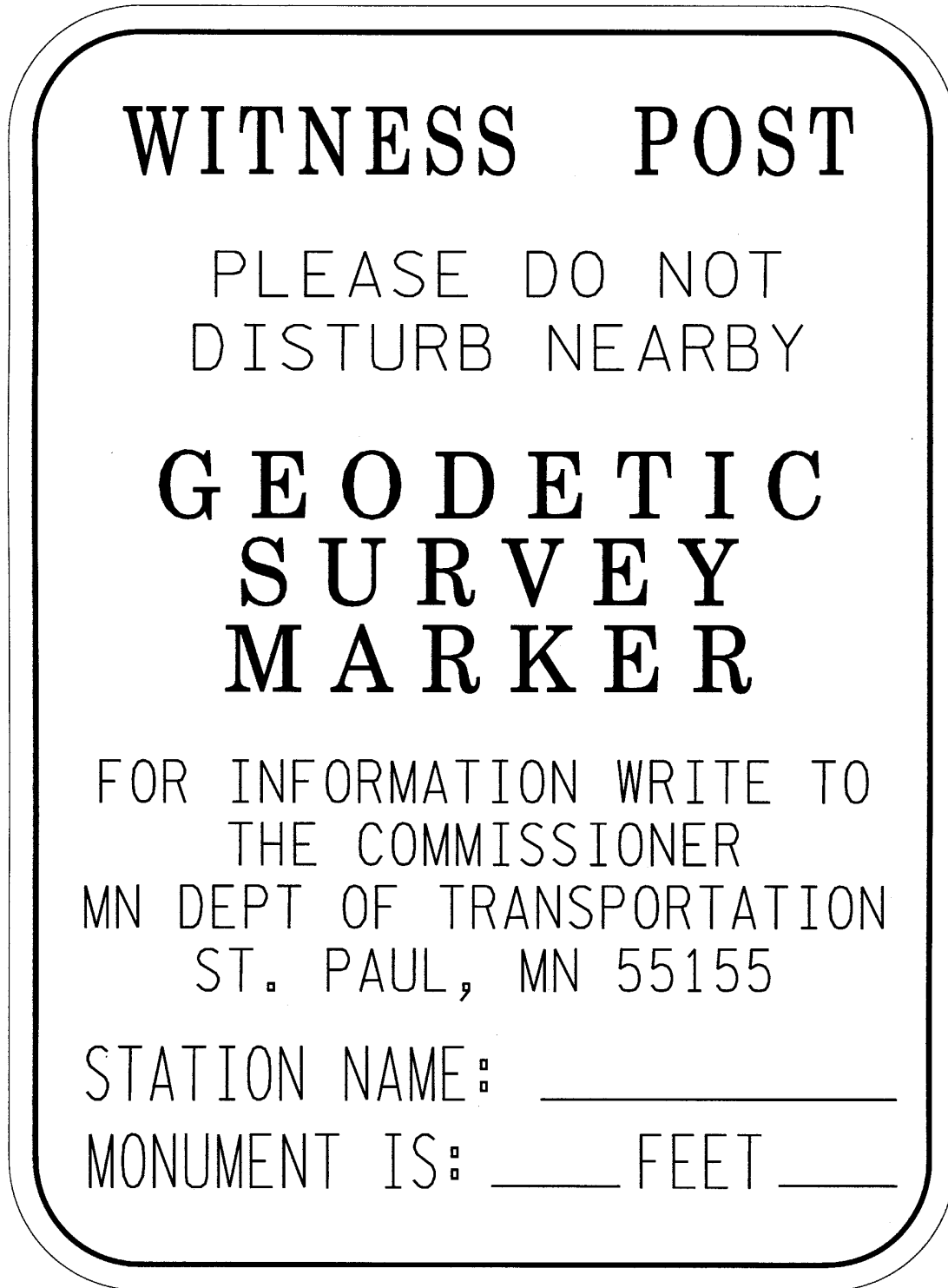

Figure 2-3.0401 Witness Post Sign

NOAA FORM 76-60 (6-71)		U. S. DEPARTMENT OF COMMERCE NATIONAL OCEANIC AND ATMOSPHERIC ADMINISTRATION REPORT ON RELOCATION OF BENCH MARK (See instructions on reverse side)			DESIGNATION OF MARK STATE _____ COUNTY _____	
A. DESCRIPTION OF ORIGINAL MARK PUBLISHED ON _____ STAMPING _____						
B. WAS ORIGINAL BENCH MARK DESTROYED? <input type="checkbox"/> YES <input type="checkbox"/> NO HORIZONTAL CONTROL POINT? <input type="checkbox"/> YES <input type="checkbox"/> NO REMARKS _____ DATE OF LEVELING _____						
(Feet or Meters)*						
POINT	B.S.	H.I.	F.S.	ELEVATION	REMARKS	
C. DESCRIPTION OF NEW MARK STAMPING ON NEW MARK _____						
SIGNED _____ AGENCY _____						
*Strike out unit NOT used.						

FIGURE 2-3.0407A REPORT ON RELOCATION OF BENCH MARK
NOAA 76-60 (front side)

SUGGESTIONS FOR RELOCATING BENCH MARKS

When a bench mark is in need of relocation the proper procedure, in most cases, is to establish the new mark in a safe place nearby and level from the old mark to the new one by means of an engineer's level and rod. The leveling should be run in duplicate to avoid the possibility of large errors, and all readings should be made to three decimal places in order to preserve the accuracy of the original survey. **It is not necessary that the new mark be established at the same elevation as the old mark.** When necessary, two temporary bench marks may be established to hold the elevation until the new mark is in place.

The old mark should not be disturbed until the observations involved in the leveling have been checked by the observer or the recorder. An assumed elevation for the old mark may be used in the leveling, since we are principally concerned with the **difference of elevation** between the old mark and the new one.

After the new mark has been established and leveled to, the old disk should be broken out and returned in the same franked sack that was used in sending the new disk. Merely turn the sack inside out to expose the return frank. If old disk cannot be returned give the reason.

Space is provided on the other side of this sheet for a copy of the field notes, the description of the original mark, description of the reset mark, and any remarks that seem desirable.

Hints, on description writing.--Directions should be compass directions, to the nearest half quadrant. If available, distances and directions to the mark from several nearby objects, such as poles, fences, trees, mileposts, culverts, etc., should be given to assist in recovery of the mark if it should be hidden in high grass or weeds. The distance and direction from the center line of the road or track followed by the level line should also be given.

Metal or white wooden witness posts have been set near many of the concrete-post bench marks. If one of these witness posts is near the bench mark to be relocated, it should be moved to a location near the new mark. A statement of the distance and direction from the witness post to the new mark should be included in the description.

The description of the new mark should be so written as to enable a stranger unfamiliar with the surrounding territory to find and identify the mark with ease and certainty, having at his disposal only the data given in the description.

The cooperation which individuals and organizations may extend to this Bureau in preserving bench marks will be a service, not only to this Bureau and other government surveying organizations, but to all who may have occasion to use the marks in the future.

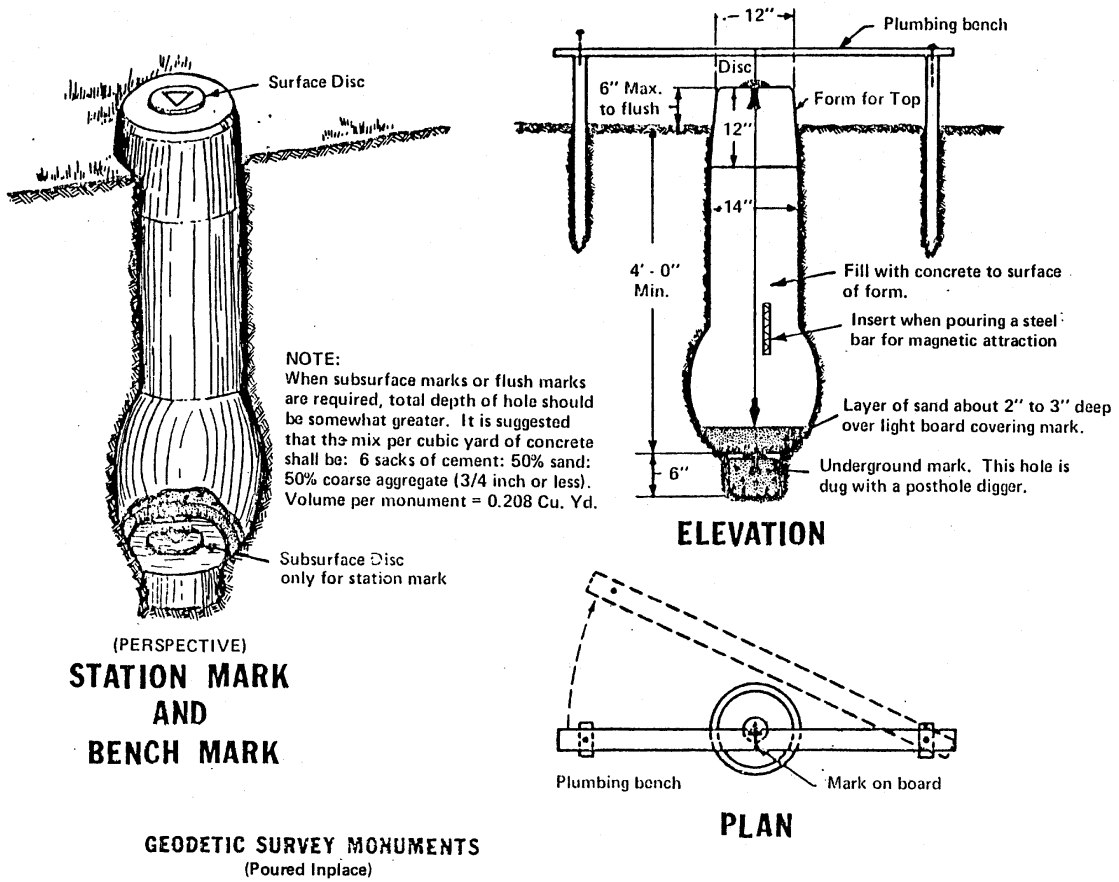

FIGURE 2-3.0502 SETTING POURED CONCRETE MARKS

Name: _____ County: _____ State: _____

1/4 Sec: _____ Sec: _____ Twp: _____ N Rng: _____ Lat _____ N Long _____ W Ell. Ht. _____

USGS Quad: _____ County Map Sheet # _____

Date-Set: _____ Agency: _____ Set-by: _____
(MM-DD-YYYY) SUPERVISOR

Monument Type/Set Code: _____ Disk Type: _____ Depth: _____

F/P/R: _____ Inches: _____ Mag Code: _____ Trans: _____ Pack: _____ GPSable?(AP): _____
ONE OF N,M,I,R,S,T,O HH:MM

Photos: 1. Close-up 2. Eye-level 3. Panoramic Dir (circle one) W NW N NE E SE S SW

STAMPING: _____ Bridge # _____

_____ MI _____ OF _____, [IN _____,]
DISTANCE DIRECTION THE NEAREST TOWN THE TOWN IT IS IN

[IN _____ IN _____ COR OF _____ NO. _____
ABUT/CULV/RAIL/HBC/ECT. QUADRANT TH/CO RD/RR/ECT. BRDG/CULV/ECT.]

OVER _____] (USE ONLY IF IN A BRDG/CULV/ECT.)
RIVER/TH/CO RD/RR

_____ MI _____ ALONG _____ FROM JCT OF _____ AND _____
DISTANCE DIRECTION ROUTE ROUTE ROUTE

IN _____, [TO TH _____ MP _____,]
NEAREST TOWN

[THENCE _____ MI _____ ON _____,]
DISTANCE DIRECTION ROUTE

(USE ONLY IF NESSECARY)

[THENCE _____ MI _____ ON _____,]
DISTANCE DIRECTION ROUTE

AT TH _____ MP _____, (USE ONLY IF THE MARK IS ON THE TRUNK HWY)

_____ FT _____ OF _____, [_____ FT _____ OF _____,]
DISTANCE DIRECTION ROUTE DISTANCE DIRECTION ROUTE

_____ FT _____ OF _____, _____ FT _____ OF _____,
DISTANCE DIRECTION OBJECT DISTANCE DIRECTION OBJECT

_____ FT _____ OF _____, _____ FT _____ OF _____,
DISTANCE DIRECTION OBJECT DISTANCE DIRECTION OBJECT

_____ FT _____ OF _____, _____ FT _____ OF _____,
DISTANCE DIRECTION OBJECT DISTANCE DIRECTION OBJECT

_____ FT _____ OF WITNESS POST _____
DISTANCE DIRECTION CIVIL TOWNSHIP

NOTES: _____

Figure 2-3.06 Description of Geodetic Control Mark.....

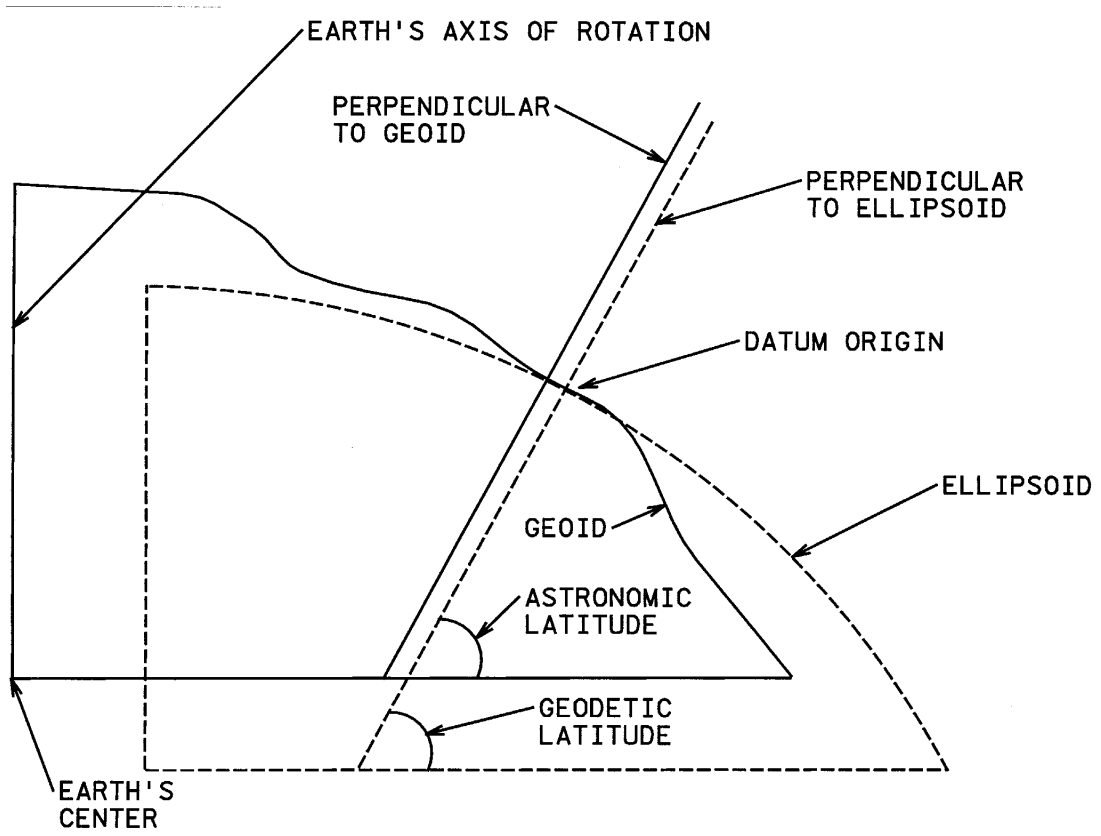

Figure 2-4.01A Diagram of Simplest Datum.....

NAD83 (1986) to NAD83 (1996) HARN

POSITION SHIFTS

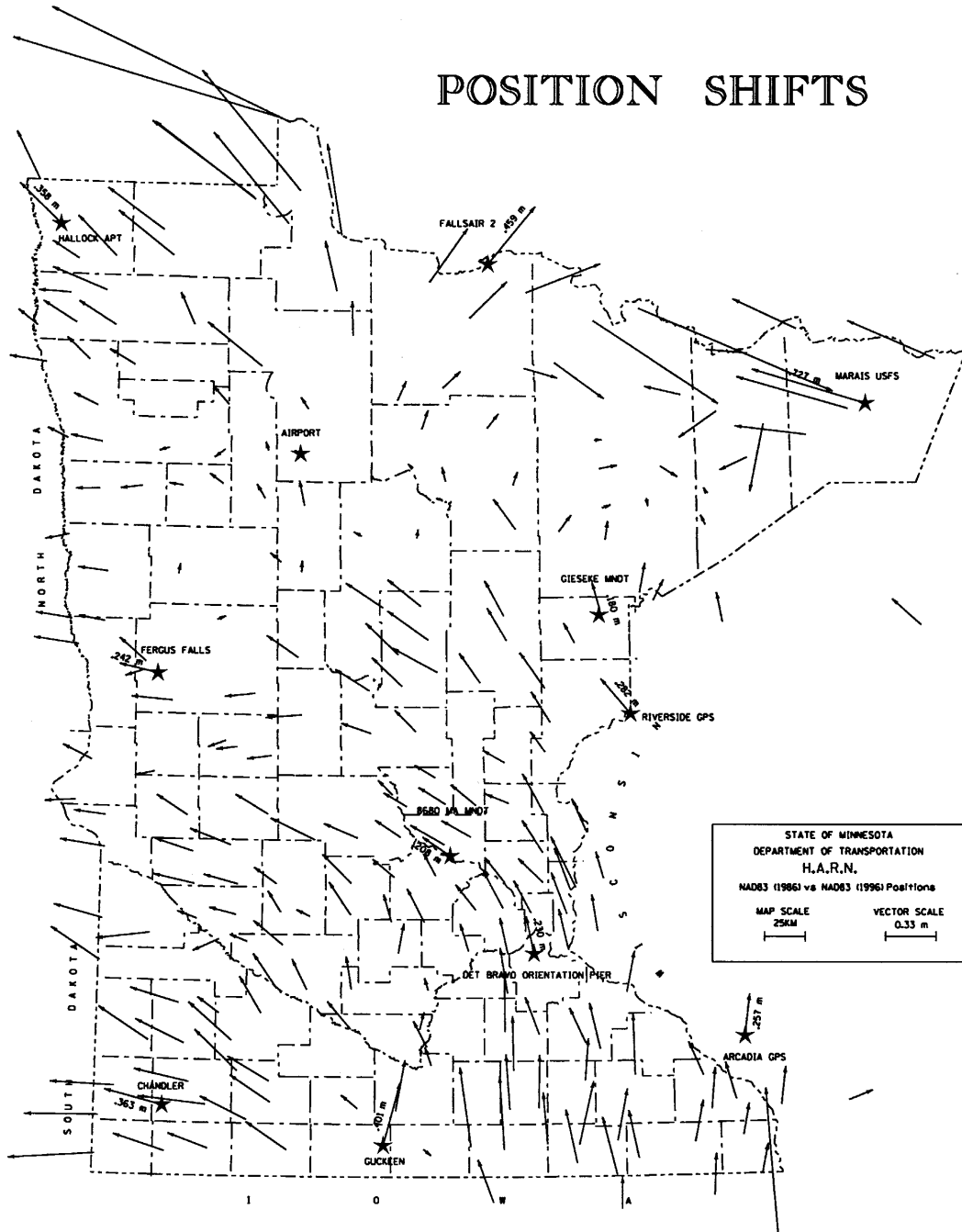

Figure 2-4.01B Position Shifts

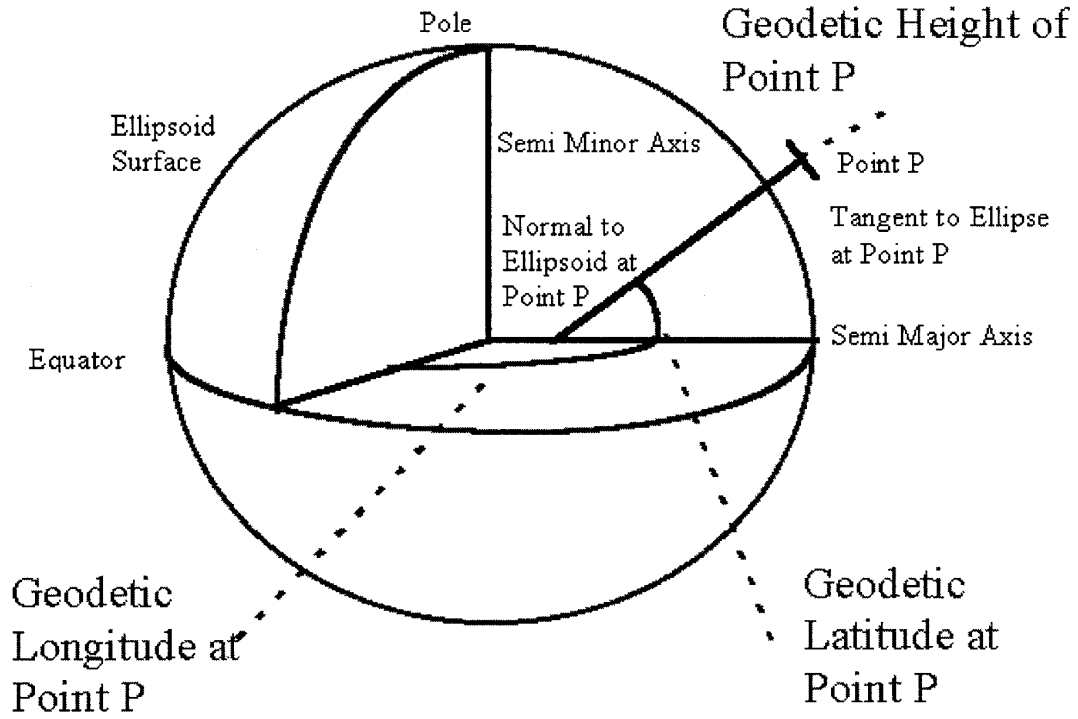

Figure 2-4.0201 Geodetic Position

.....

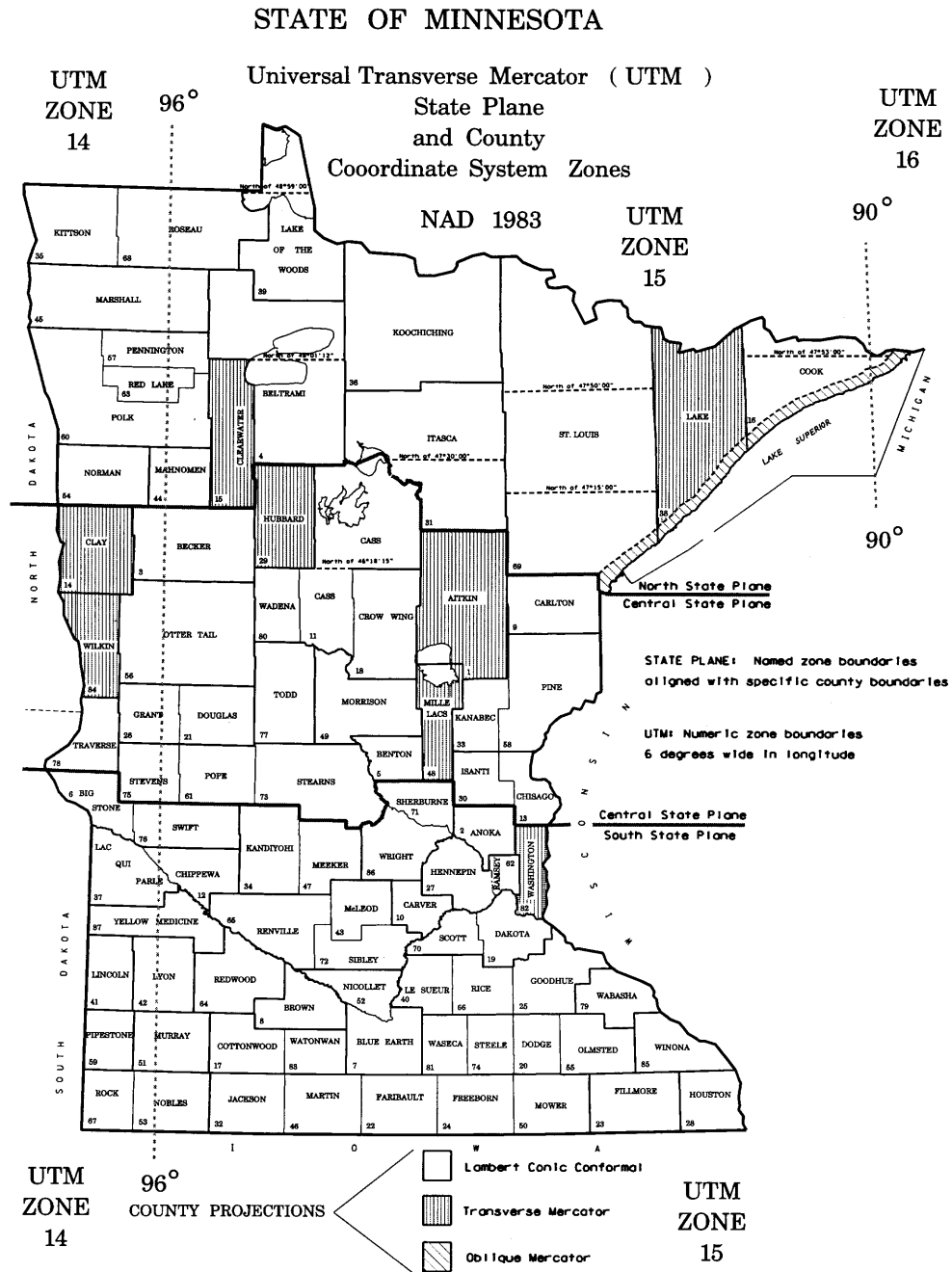

FIGURE 2-4.0203 COUNTY COORDINATE ZONES AND STATE PLANE ZONE BOUNDARIES

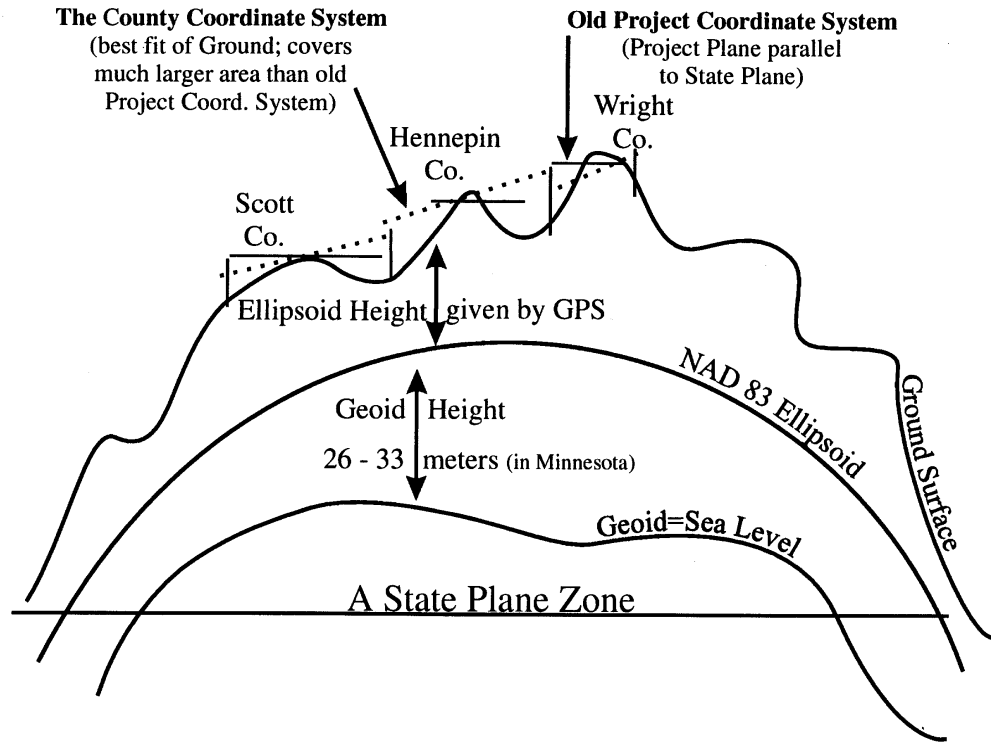

FIGURE 2-40205A RELATIONSHIP OF THE VARIOUS COORDINATE PROJECTIONS TO THE ELLIPSOID AND GEOID

COMMON PROJECTIONS USED IN SURVEYING & MAPPING

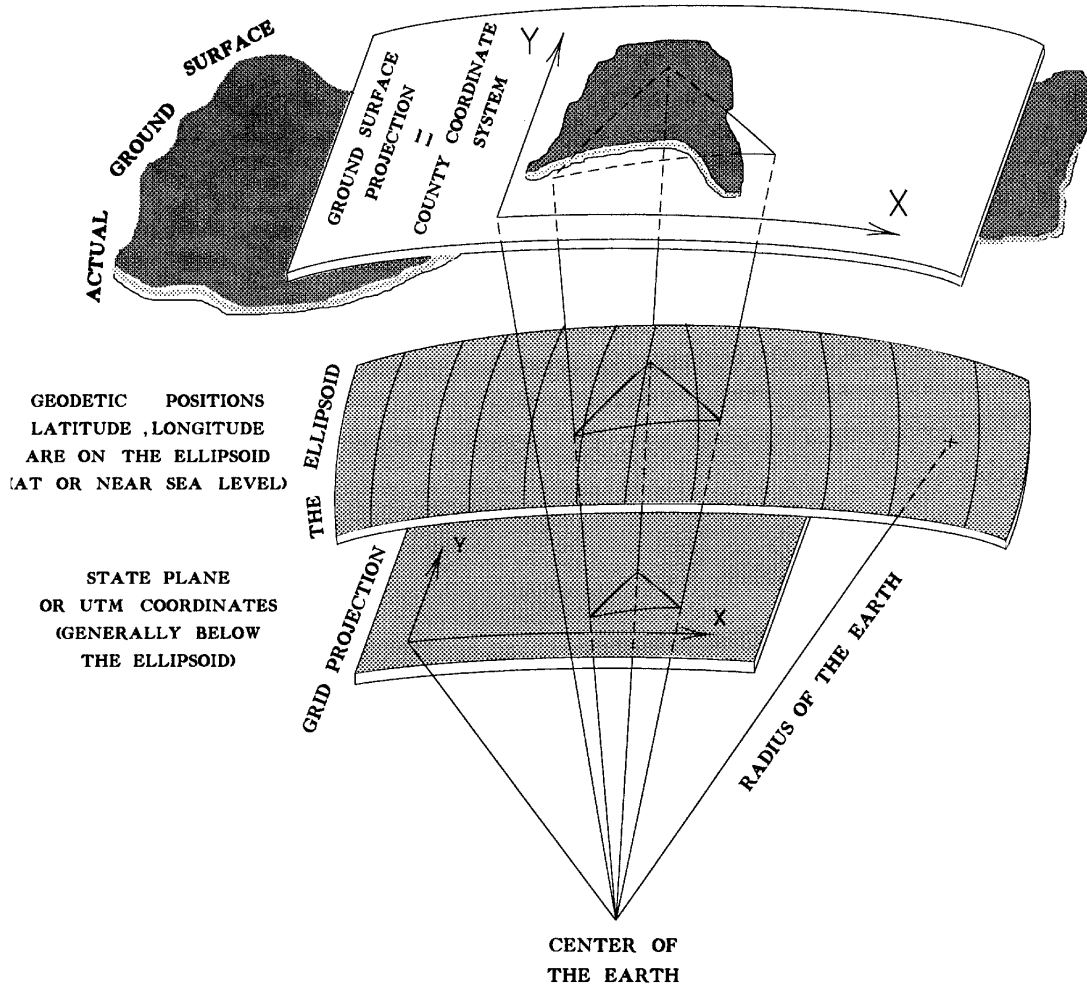

Figure 2-40205B Comparison of Ground Distance to Sea Level Distance and State Plane Grid Distance

T.H. 75	SEC. 17 T. 117N R. 44W	AT DAMP		
S.P. 3702-17	COUNTY Lac Qui Parle	POINT Punch Mark - 3/4" IP		
<p style="text-align: center;"><u>DIRECTIONS</u></p>		<p style="text-align: center;"><u>REFERENCE TIES</u></p> <p>3/4" Iron Pin with punch mark down 0.2 Ft. 26.0 ft east of TH 75 E 22.5 ft south of Top Ad E TH 75 mile Point 104.8</p>		
PROJECT COORDINATES	C'ked by	ELEVATION		
X= _____		_____ Ft. MSL Elev. 1929 Datum		
Y= _____		B.M. Tabulation		
Report				
FINAL DATA FROM COORDINATES				
TO POINT	X	Y	DISTANCE	AZIMUTH (0° = NORTH)

Figure 2-40501A Mn/DOT Horizontal Field Note Form (No 21863)

INSTR. AT DAMP		Instr. Type	Serial Number	Observer HTS	Date	
POINT 3/4" IP w/Ranch Mark		Angle T2	191872	Recorder TAM	3/9/78	
		Distance H.P. 3800	W9A 01061	Crew CP & DS		
TO POINT	1st SET	HORIZONTAL READINGS			DIRECTIONS	MEAN DIRECTIONS
MAD	D 00 00 40.0 40.0 40.0	33.0"				
3/4" IP w/Disk	R 180 00 26.0 26.0 26.0					
2482 Pole	D 37 02 36.0 36.0 36.0	27.5			37° 01' 54.5"	37° 01' 50.0"
	R 217 02 19.0 19.0 19.0					
FOG	D 42 32 42.0 42.0 42.0	35.0			42 32 02.0	42 32 00.8
IP w/Disk	R 222 32 28.0 28.0 28.0					
Vert. Triang. Point	D 178 54 36.0 36.0 36.0	28.5			178 53 55.5	178 53 53.8
Top 2393	R 358 54 21.0 21.0 21.0					
CLAYT	D 219 45 47.0 47.0 47.0	41.0			219 45 08.0	219 45 08.5
Alum. Cap on Sq. Pipe	R 39 45 35.0 35.0 35.0					
2382 Pole	D 221 56 49.0 49.0 49.0	38.5			221 56 05.5	221 56 07.5
	R 41 56 28.0 28.0 28.0					
2nd SET					REMARKS	
Vert. Triang. Point	D 270° 40' 23.0" 23.0" 23.0"	14.5"			270° 39' 41.5"	270° 39' 39.8"
Low 2391	R 90 40 06.0 06.0 06.0					
2481 Pole	D 309 40 36.0 36.0 36.0	28.5			309° 39' 55.5"	309 39 50.8
	R 129 40 21.0 21.0 21.0					
	D _____					
	R _____					
	D _____					
	R _____					
	D _____					
	R _____					
	D _____					
	R _____					
		VERTICAL ANGLES		DISTANCES		
MAD	D 90° 03' 16" _____	Slope (Ft. or M.)		Corr. Slope	Horiz. (Ft.)	
3/4" IP w/Disk	R 269 56 44 _____	1 7117.35				
	X 00 03 16 _____	2 Ecc 7116.33				
2482 Pole	D //////	//////			Chained	
	R //////	//////			203.31	
	X _____					
FOG	D 90 27 35 _____	3451.80				
3/4" IP w/Disk	R 269 32 40 _____	2 Ecc 3450.80				
	X 00 27 27.5 _____					
Vert. Triang. Pt.	D 90 11 05 _____	1604.49				
Top 2393	R 269 48 48 _____	2 Ecc 1603.49				
	X 00 11 08.5 _____					
CLAYT	D 89 55 53 _____	2151.92				
Alum. Cap on Sq. Pipe	R 270 04 07 _____	2 Ecc 2150.92				
	X 00 04 07.0 _____					

FIGURE 2-4.0501B MN/DOT HORIZONTAL FIELD NOTE FORM (NO. 21863)

NAVD 88 MINUS NGVD 29 ADJUSTED ELEVATIONS
NOVEMBER, 1991
(IN METERS)

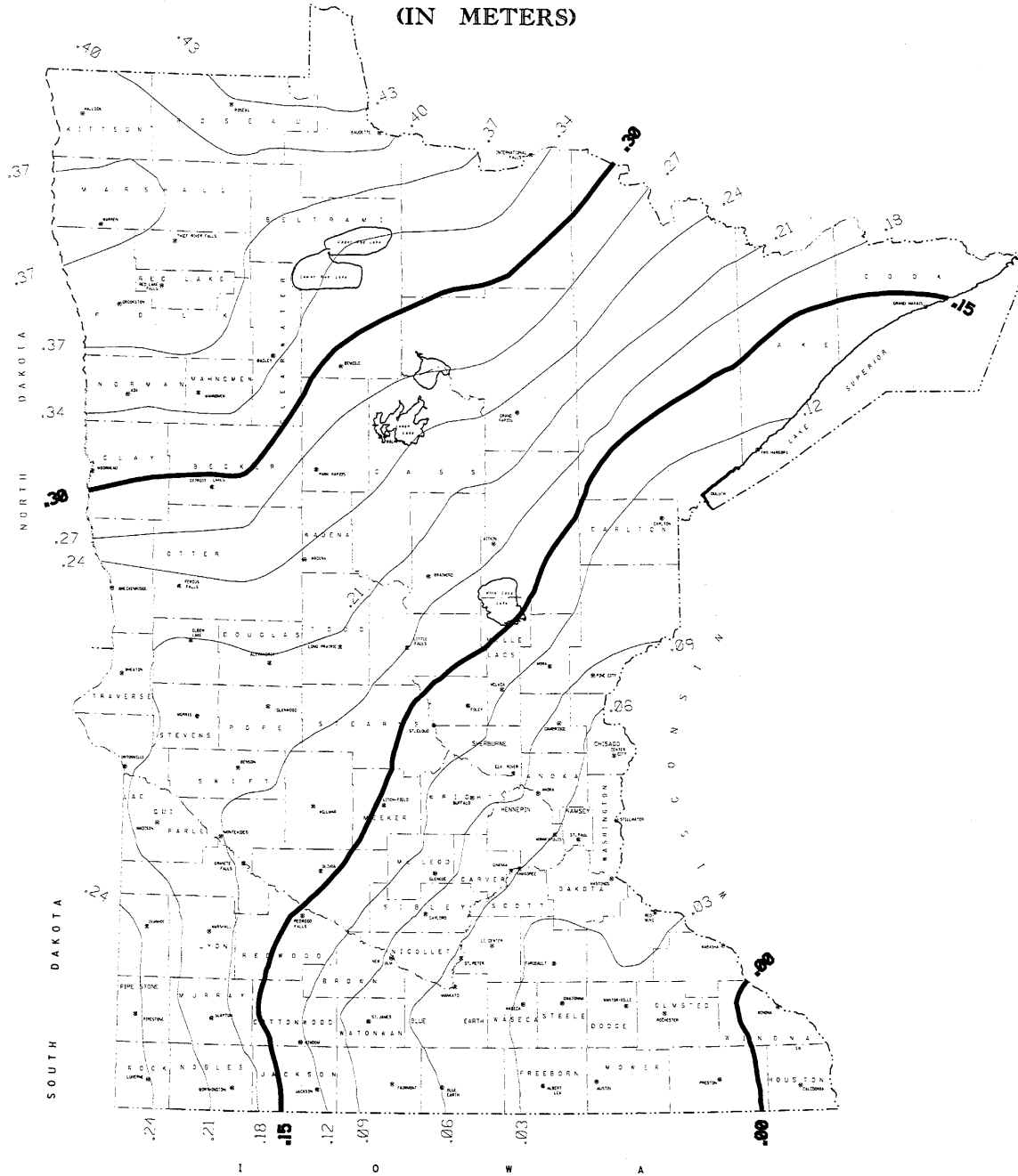

FIGURE 2-5.0102 VERTICAL SHIFTS BETWEEN NGVD29 AND NAVD 88

NOAA FORM 76-187 (8-76)		U.S. DEPARTMENT OF COMMERCE NATIONAL OCEANIC AND ATMOSPHERIC ADMINISTRATION			
GEODETTIC LEVELING FIELD ABSTRACT					
HGZ L			SHEET		SHEETS
					OF
TITLE					
DISTANCE UNITS: KM SM		D/F.E. UNITS: MT FT		Mo. / Day	F. / B.
				DISTANCE Δ/Σ	D
				$-(B+F) / \Delta/\Sigma$	$\bar{D}/F.E.$
*30" FROM					
TO					
*30" FROM					
TO					
*30" FROM					
TO					
*30" FROM					
TO					
*30" FROM					
TO					
*30" FROM					
TO					
*30" FROM					
TO					
*30" FROM					
TO					
*30" FROM					
TO					
*30" FROM					
TO					
*30" FROM					
TO					

SUPERSEDES NOAA FORM 76-148 (11-72) WHICH IS OBSOLETE, AND EXISTING STOCK SHOULD BE DESTROYED UPON RECEIPT OF REVISION.

© U.S. Government Printing Office: 1977-765-005/1144 Reprint No. 4

FIGURE 2-5.0301 GEODETTIC LEVELING FIELD ABSTRACT NOAA 76-187

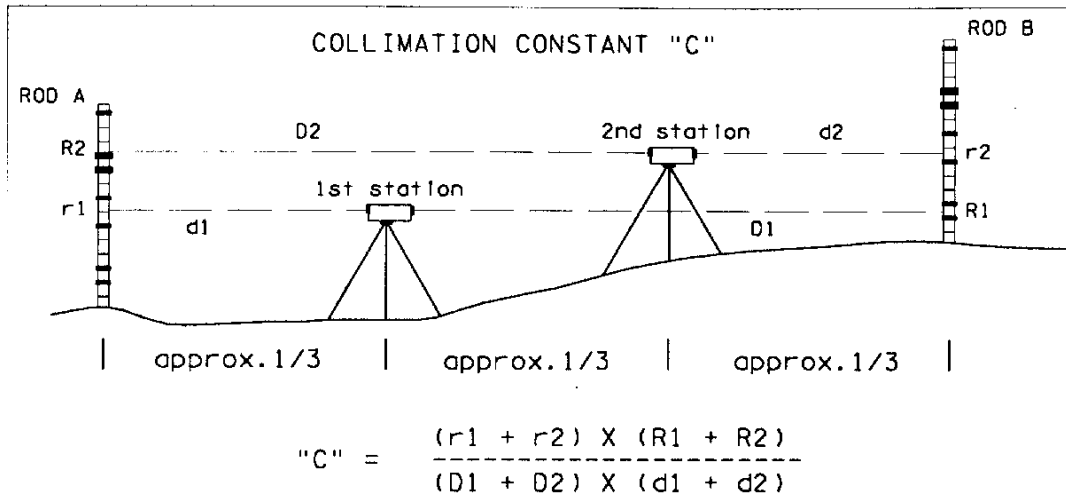

FIGURE 2-5.0302 TWO PEG TEST (FORSTNER METHOD)

CONTROL LEVELING

THREE WIRE

Project 6008 Inst. ZEISS NI2 Weather CLOUDY-COLD Observer R. SANDMAN
 Date 1-20-77 Rods METER 102791-3 Wind CALM - 5 MPH Recorder K. PEARSON
 From B.M. 6008 K To B.M. G 70 "c" Temp. +10° Rodmen J. LEITHEISER, F. HEIMARK

STATION NUMBER	BACKSIGHT					FORESIGHT					NOTES
	THREAD READINGS	MEAN METER	MIDDLE THREAD-FT.	INTERVALS THREAD	SUM	THREAD READINGS	MEAN METER	MIDDLE THREAD-FT.	INTERVALS THREAD	SUM	
1	0912				.077	1509				.079	Mn/DOT B.M. 6008 K 10 S' RT. STA. 1135+75
	0835	08350	274		.077	1430	14300	469		.079	
	0758				.154	1351				.158	
2	1683				.087	1478				.101	
	1596	15957	523		.088	1377	13770	452		.101	
	1508				.175	1276				.302	
3	1804				.086	1968				.086	
	1718	17180	564		.086	1882	18820	617		.086	
	1632				.172	1796				.172	
4	1342				.081	1707				.097	
	1261	12610	414		.081	1610	16100	528		.097	
	1180				.162	1513				.194	
5	1408				.086	2543				.086	
	1322	13220	434		.086	2457	24563	806		.088	
	1236				.172	2369				.174	
6	0835				.084	2067				.092	
	0751	07513	246		.083	1975	19750	648		.092	
	0668				.167	1883				.184	
7	1871				.083	1539				.070	USC + 6S B.M. 670
	1788	17877	587		.084	1469	14693	482		.069	
	1704				.167	1400				.139	
		927107	3042				121996	4002			

FORM 21857 (MHD)

Sheet 15 of 65

FIGURE 2-5.0401 CONTROL LEVELING THREE WIRE MN/DOT FORM 21857

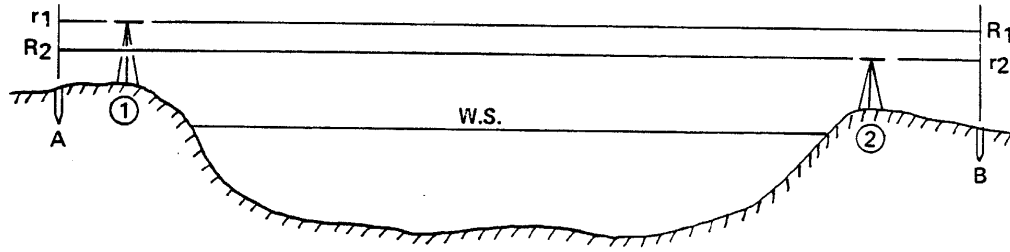

PROJECT: 6280-18 5307-18				WEATHER: CLEAR-WARM		DATE: 3-10-88	
Bm 5307 A	12.43	1445.19	1432.76 = 436.706 M.	●	Bm DISK IN SOLIC	MUN	PARTY: FRANK JOHANSON MNNDT 3rd order CS 5307
		1.27	1443.92	●			
	7.57	1451.49	1447.76	●			
-	6.74	1454.50	1451.39	●			
	6.64	1458.03	1452.96 = 442.863 M.	●	HEM DISK ON Rod		
STAIN	4.53	1457.49	1449.23	●			
	3.78	1453.01	1446.27	●	Top of rock		
TBm	3.41	1449.68	1440.21	●			
	2.53	1442.24	1432.76	●	SAME AS ABOVE		
Bm 5307 A	9.97	1432.77	1432.76	●			
J.W. GARD 4-12-88							

CHAPTER 3 - LAND SURVEYS

- 3-1 INTRODUCTION**
- 3-2 ORGANIZATION**
- 3-3 PUBLIC LAND SURVEYS/PRIVATE BOUNDARY CORNERS**
 - 3-3.01 RECORD RESEARCH**
 - 3-3.0101 U.S. Government Survey Records**
 - 3-3.0102 State Survey records**
 - 3-3.0103 County Surveys records**
 - 3-3.0105 Private Records and Local Knowledge**
 - 3-3.02 FIELD RESEARCH**
 - 3-3.0201 Verification of Records Evidence**
 - 3-3.0202 Reconnaissance of Occupation Lines and Roads**
 - 3-3.0203 Interviews-Property Owners & Local Residents**
 - 3-3.0204 Search for Unrecorded Monuments**
 - 3-3.03 MONUMENT PERPETUATION**
 - 3-3.04 ANALYSIS**
 - 3-3.0401 Methods for Determining Position of Government Corners**
 - 3-3.05 PUBLIC LAND CORNER MONUMENTATION**
 - 3-3.0501 Government Monuments**
 - 3-3.0502 Private Land Surveyor Monuments**
 - 3-3.0503 Reference Ties and Witness Posts**
- 3-4 CERTIFICATES OF LOCATION OF GOVERNMENT CORNERS**
 - 3-4.01 INSTRUMENTS FOR PREPARATION OF CERTIFICATE OF LOCATION OF GOVERNMENT CORNER**
 - 3-4.02 FILING OF CERTIFICATE OF LOCATION OF GOVERNMENT CORNER**
 - 3-4.03 Mn/DOT's CORNER CERTIFICATE POLICY**

- 3-5 R/W BASE MAP**
 - 3-5.01 SPECIFICATIONS**
 - 3-5.02 PREPARATION**
 - 3-5.0201 Map Content**
 - 3-5.0202 Text Annotation**

- 3.6 R/W STAFF AUTHORIZATION MAP**

- 3.7 RIGHT OF WAY PLATS**
 - 3-7.01 RIGHT OF WAY PLATS**
 - 3-7.0101 Computation of Boundary Corners**
 - 3-7.0102 Plat Development**
 - 3-7.0103 Plat Monumentation**
 - 3-7.0104 Final Preparation of Plats**
 - 3-7.0105 Certificate and Signatures**
 - 3-7.0106 Reproduction and Distribution**
 - 3-7.0107 Plat Revisions**
 - 3-7.02 PROPERTY SURVEY MAP**
 - 3-7.03 MONUMENTATION PLAT**

- 3-8 R/W ACQUISITION BY METERS AND BOUNDS DESCRIPTIONS**

- 3-9 FINAL R/W MAP**

- 3-10 SPECIAL SURVEYS**
 - 3-10.01 SITE SURVEYS**
 - 3-10.02 REGISTERED LAND SURVEYS**
 - 3-10.03 RECONVEYANCE SURVEYS**
 - 3-10.0301 Surveys of Critical Topography**
 - 3-10.0302 Establish Land Ties**
 - 3-10.0303 Establish Line Data for Description**

3-11 TURNBACKS

3-11.01 SURVEYS OF CRITICAL TOPOGRAPHY

3-11.02 ESTABLISH LAND TIES

3-11.03 ESTABLISH LINE DATA FOR DESCRIPTION

3-11.04 TURNBACK AUTHORIZATION MAP

3-12 MISCELLANEOUS R/W STAKING

3-12.01 R/W STAKING FOR VIEWING OR APPRAISING

3-12.02 R/W STAKING AT THE REQUEST OF ADJOINING PROPERTY OWNERS

3-12.03 R/W STAKING FOR PRIVATE LAND SURVEYORS

CHAPTER 3 - LAND SURVEYS

3-1 INTRODUCTION

Chapter 3 - Land Surveys documents the policies, standards, and procedures regarding boundary control of Mn/DOT land. Most of the material is directed toward operations at the district level. The function of the Central Office of Land Management and the services rendered by it are also addressed.

In addition to the material contained in this chapter, the reader is referred to the Mn/DOT Right of Way Manual due to overlap between the right of way and surveying and mapping functions. Liaison between these groups is essential to eliminate duplication of effort and to coordinate land-related activities.

3-2 ORGANIZATION

Land survey operations are handled primarily at the district level with review and guidance from the Central Office Surveying and Mapping Section, primarily the Legal Descriptions and Commissioner's Orders Unit and the Platting Unit. The functions of this section are as follows:

- a. To finalize right of way plats.
- b. To review all land survey related documents that Mn/DOT files for public record. To maintain uniformity and standards on a statewide basis.
- c. To assist district land surveyors in solving land corner location problems. The Surveying and Mapping Section maintains a file of case histories and the Minnesota Statutes with annotations on court cases related to boundaries to assist the districts. In addition, data is collected from private surveyors, county surveyors and other agencies to provide additional information.
- d. To assist in making decisions as to the proper location of highway right of way lines in complex or controversial situations. Consultations with the Office of the Attorney General may be required in special cases.
- e. To maintain a liaison with the Office of Attorney General on all land surveying related matters and description writing.
- f. To establish policies and procedures and to keep the land surveys chapter of this manual up to date.
- g. To maintain liaison with other governmental agencies (e.g. DNR, US Forest Service, Corps of Engineers, etc.) on land surveying related matters.
- h. To conduct, coordinate and supervise research projects.
- i. To maintain a professional surveys development program for Mn/DOT.

3-3 PUBLIC LAND SURVEY/PRIVATE BOUNDARY CORNERS

The location, re-establishment and perpetuation and certification of land corners on or near highway properties and right of way are of utmost importance to the Minnesota Department of Transportation (Mn/DOT) and to the public. Legal descriptions and highway plats and maps used in the purchase of highway property are based on these government land corners. If one of these government corners is incorrectly positioned or the wrong location is used as the government corner, all of the property described or referenced from this corner could be open to future boundary disputes and/or costly litigation.

Minnesota Statutes 160.15 requires the road authority to perpetuate and replace all known section and quarter section corners that are destroyed or obliterated by construction, reconstruction or maintenance of a public highway. The responsibility by law is assigned to the road authority having jurisdiction over the road. In Mn/DOT, the district surveyor/engineer is responsible for compliance with this law. For further guidance on this subject see, the *Mn/DOT "Certificate of Location Of Government Corner" Policy* in APPENDIX B of this manual.

Private boundary corners are usually corners marking subdivision plats, registered land surveys, and/or metes and bounds surveys. The location, re-establishment and perpetuation of these corners are a necessity to highway right-of-way acquisition and monumentation. For more on this subject see, the **Obliterated Property Corner Monument Policy** in APPENDIX B of this manual.

Minnesota Statutes 505.32 states that no previously existing survey or reference monuments or land marks evidencing property lines or corner posts shall be removed or destroyed by the surveyor of a new survey.

3-3.01 RECORD RESEARCH

The location and restoration of public land and private boundary corners requires a thorough research of all the survey records, recorded and unrecorded for the particular area. The research of the public recorded survey data can be researched by starting with the original Public Land Surveys (PLS) of the United States Government, followed by state, county, township, city and private surveys.

The research of private boundary corners will be more difficult as the survey data may not be of public record and is usually stored in private files of present and past property owners, private land surveyors, or by others.

3-3.0101 U.S. Government Survey Records

There were and are different federal agencies that have made surveys in the State of Minnesota. The records of these surveys are available as explained below.

- a. In Minnesota, the Secretary of State is the official keeper of the original Public Land Survey and resurvey records. These records consist of the original and resurvey township plats and field notes made by the U.S. Government Land Office and Bureau of Land Management. Some of the county offices have the same records. To secure these records, a request to the LIS and R/W Mapping Unit in the Central Office should be made by the district surveys.

- b. In some cases, there may be records of a survey made by the Bureau of Land Management that the Secretary of State does not have. Should this be the case, the records can be obtained from the Eastern States Office of Bureau of Land Management, Springfield, Virginia, 22153.
- c. The U.S. Army Corps of Engineers made surveys in Minnesota, primarily along the Mississippi River. The records of these surveys can be obtained from the Corps' district office in St. Paul, Minnesota, 55101.
- d. There are areas of land in Minnesota owned by the U.S. Government, especially in northern Minnesota. Most of this land is under the jurisdiction of the U.S. Forest Service. The Forest Service is continually making surveys of their lands that are usually very complete and well recorded. The records of these surveys can be obtained from the appropriate U.S. Forest Service district headquarters.

U.S. Forest Service
Chippewa National Forest
Cass Lake, Minnesota 56633

U.S. Forest Service
Superior National Forest
8901 Grand Place
Duluth, Minnesota 55808-1102

- e. The Federal Court may have survey information on court cases related to boundary problems. To research the court record, it is necessary to know the names of the plaintiff and defendant, as well as the date of action.
- f. Other sources of survey information: National Fish & Wildlife Service; National Park Service; Bureau of Indian Affairs; and WPA Projects.

3-3.0102 *State Survey Records*

Most state surveys were done for highways, lakeshores, rivers, and forests. These surveys and records are as follows:

- a. Mn/DOT has survey records on land corners along most of the state highways. These survey records are in note and graphic form. The graphics can be plan sheets, construction profile, hardshell right of way maps, and plats. All of the notes and most of the graphics are on file in the district survey section along with Certificates of Location of government corners. The Central Office may also be a resource for survey records.
- b. The Minnesota Department of Natural Resources has records of surveys available by one of the following:
 1. Engineering Bureau
 2. Real Estate Management Bureau
 3. Forestry Division
 4. Minerals Division
 5. Parks and Recreation Division
 6. Waters Division

Local Area Foresters should be contacted for records of forest surveys.

- c. The Minnesota Historical Society may have survey information in the form of old plats, maps, notes, books, etc. This research is very time consuming and should be limited to unique cases.

3-3.0103 County Survey Records

Property and survey records may be found and researched in the following offices:

- a. County Surveyor (full time): This office should be completely researched. It contains Certificates of Location of government corners, survey record books, section or half-section maps, record plats, auditor plats, aerial photos, resurvey data, etc.

The records in the office of a part-time county surveyor shall be researched using the same procedure outlined in Section 3-3.0105a.

- b. County Highway Department: The volume and content of survey records in each highway office will vary greatly. Some highway offices may contain the entire survey record system for the county; on the other hand one may find a complete void of survey records in some county highway offices.
- c. County Recorder, Registrar of Titles: The research in these offices requires the researcher to be thoroughly familiar with tract indexing and county record systems. This office may contain records regarding the Public Land Survey, Certificates of Location of government land corners, and some private survey records. In most counties you may expect to find record descriptions, record plats, and auditors' plats. The descriptions of metes and bounds tracts should be carefully checked as they may indicate evidence of a previous survey.
- d. County Auditor: One should research the data in this office regarding road orders and drainage ditches. The auditor may also be able to identify the problem areas within the county in regard to property boundary identification and surveys. The auditor may also have recent aerial photos of the county.
- e. County Assessor: One should research the data in this office regarding property descriptions. The assessor may be able to supplement the knowledge of the auditor regarding property boundary identification.
- f. County Clerk of Court: The Clerk may have survey information on court cases heard in the District Court. These records will show any judicial land corners and boundary markers ordered by the court. To research these records it is necessary to know the name of the plaintiff and/or defendant.
- g. County Historical Society: These records may be used but research should be limited to unique cases.

3-3.0104 Township and City Records

Property and survey records may be found and researched in the following sources:

- a. Road and Street Department: This research should include anyone (former or present employees) who has been involved in the construction or maintenance of improvements.
- b. Clerk (former or present): The clerk is usually knowledgeable in regard to boundaries because of local government involvement. The clerk may be able to identify other people with knowledge of boundaries.
- c. Board or Council Members (former or present): Council members are usually knowledgeable in local boundary problems or are key people in identifying other knowledgeable owners and residents in local boundary problems.

3-3.0105 Private Records and Local Knowledge

Private records and local knowledge should be researched as follows:

- a. Private surveyors including part-time county surveyors. The district surveyor shall contact these surveyors to explain the scope of the Mn/DOT project and request and obtain all pertinent available data to the project. The resultant updated survey data will be beneficial to the private surveyors.
- b. Engineers: Same as Section 3-3.0105a in this manual. Engineering firms that are consultants for city or township governments usually retain survey data relating to government land corners.
- c. Land Owners: Land owners should be contacted and interviewed for knowledge of PLS corners if their land abuts section or quarter section lines. The landowners should also be contacted as to the location of their boundary corners. See Section 3-3.0203 in this manual.
- d. Former owners and local residents: These people are usually identified through previous interviews of government officials, landowners, and record information. Their testimony can be valuable in developing parol evidence for obliterated corners and to provide clues for other evidence. See Section 3-3.0203 in this manual.
- e. Utility Companies and Large Corporations: Same as Section 3-3.0105a in this manual. The utility alignment, utility R/W or easement, and other engineering data needed should be defined by the Mn/DOT user, i.e., design, hydraulics, right of way, etc. Sources to research are:

1. Electric	4. Mining
2. Railroad	5. Wood Products
3. Communication	6. Pipe Lines
- f. Abstract Company: The county or local abstract company should be researched. This should be done by calling the company and explaining to them what information is needed.

3-3.02 FIELD RESEARCH

A diligent search shall be made to find all public land corner and private property monuments that fall within, abut or impact the area of highway construction. The inclusion of all necessary land corners for legal land ties is of utmost importance. It is helpful to have aerial photography, digital orthophotos, quadrangle maps, and GPS search coordinates to assist with the field research.

After the written evidence has been researched, the information obtained should be verified on the ground. Ground checks are made for possible gaps, overlaps and discrepancies in the survey data that would have an effect on Mn/DOT right of way.

3-3.0201 Verification of Record Evidence

The first phase of field research should be the location of known monuments that do exist. Such monuments are based on records that they do exist subject to local changes that might indicate that the monument has been destroyed, e.g., deep road excavation after the date the record evidence was collected. The following steps should be taken:

- a. Check of reference ties: If there are reference ties on record for the land corners, they should be checked. Any major difference in distance for these ties to a monument should be noted. It is important that no new ties be added to the same trees, poles, etc. that are already being used for a reference tie as this may lead to confusion at a later date.
- b. Magnetic locator: The magnetic locator affords a very quick and efficient means of locating ferrous metallic monuments. For example, one tie could be used in combination with the locator and the point found. At this time the other existing ties should be checked.
- c. Excavation. If not readily visible, the monument marking the land corner may have been covered by several feet of dirt or by a roadway. In this case, searching an area large enough and deep enough that leaves no doubt that a monument is existing, must be excavated. Existing construction plans of the area should be researched to determine if the area is in a "cut" or "fill" area. Depending on conditions, the excavation could be done with a jackhammer and spade, pick and shovel, or a backhoe. Care must be taken so that the corner is not damaged, moved or destroyed in this excavation. Color photographs should be taken of the excavation and any monuments or evidence found. The photographs should show the size of the evidence found and the relationship of the monument to occupation lines if they exist.

In looking for lot corner monuments, it will suffice most of the time to excavate with a shovel. Usually these monuments are within one to three feet of the surface of the ground. In developed areas, neatly replace the sod when finished.

3-3.0202 Reconnaissance of Occupation Lines and Roads

A field check should be made for occupation lines, roads, sixteenth corners, and property corners which could be used to substantiate a PLS corner.

Those elements to be used to substantiate a corner must be tied to the control survey. An indexing system, i.e., marking on a quadrangle sheet, in notes, or flagging in the field, must be used so that these points are known to the field survey crew.

If lot corner monuments are missing or do not seem to fit the occupation lines, it should be noted on the field blue line of the plat or on the certificate of survey. Occupation lines may have to be tied in to analyze and verify the platting.

3-3.0203 Interviews – Property Owners & Local Residents

Before the interview, the interviewer should become knowledgeable in the extent of the project and the approximate dates of various phases of the planned construction. The interviewer should also understand the limits on information he/she can give. In cases regarding specific questions relative to areas in Mn/DOT outside of surveying, the interviewer should indicate the question will be relayed to the proper section. After forwarding the question to the proper section, inform the interviewee by letter to whom the question has been referred.

The following steps are a guide to establish a business format for the interview.

- a. Prepare a comprehensive list of questions before the date of the interview. The following are samples of frequently asked questions:

1. How many years have you lived in the area?
 2. How many years have you owned or occupied this property?
 3. How long has a specific improvement (road, fence, building) existed?
 4. Did the improvement in Item 3 replace a previous improvement? If so, when?
 5. Was either, old or present, improvement placed by a survey? If yes, find out by whom and when. Ask to see certificate of survey of the work.
 6. Do you have knowledge of your property corners? Would you help me locate the monuments?
 7. Have there been property disputes, feuds, or legal proceedings over property boundaries in the vicinity?
 8. Do you have knowledge of the location of section, quarter, meander, or judicial monuments in the area?
 9. Where are the locations of any wells (used or unused) within 20 ft of Mn/DOT right of way?
 10. Where are judicial ditches, drains or field tile lines located?
 11. Do you have any knowledge of dates, elevation, or horizontal position limits of high water during floods?
- b. Introduce yourself: Give your name, title and office location. Calling cards can be helpful for those who do extensive interviewing.
- c. Inform the interviewee of:
1. The project you are working on.
 2. The nature of the project.
 3. The information needed.
 4. When you may return to do work in the area.
 5. Arrange for a convenient time to return if more information is needed.
- d. Interview: During the interview make short written notes of names, dates and significant facts. Upon completion of the interview write neat and complete notes. If you need a statement relating to the verification of a corner monument, many times such statements can be drafted and signed during the interview.

Sample: I, John Doe, being a resident of the Southwest Quarter of the Southwest Quarter, Section 9, Township 141 North, Range 29 West for over 60 years saw a squared sandstone monument at the southwest corner of said section. The stone was near the center of the E-W road in line with the fence to the north.

3-3.0204 Search for Unrecorded Monuments

- a. Magnetic Locator: A search should be made at road intersections, fence intersections, etc. for possible monuments even if there is no record evidence available. Many government corners were set by private surveyors, which were not filed in any public records. When such monuments are found they may have registration numbers or other identifiable characteristics that may lead to their origin.

- b. Excavation. No excavation should be done at random. If a reading registers on a magnetic locator some digging should be done. If extensive excavation is involved it should be done after all evidence has been analyzed through a control survey.

3-3.03 MONUMENT PERPETUATION

Where the highway right of way takes partial lots or tracts, the position of the old corner monuments are crucial to private surveyors for future location of property lines.

The block and lot corner monuments of subdivision plats may be the only evidence by which the correct corner monument can be reestablished.

A record of all monuments found shall be kept in the survey report as to the type, size, and registration number of the surveyor who set the monument if known. All found monuments shall have their position perpetuated by making ties to the control survey. Include the date of recovery and the coordinates, to include coordinate system, datum, and adjustment, of the monuments in the survey report for future reference.

3-3.04 ANALYSIS

Reconstructing boundary corner locations from written, survey, parol, and physical evidence requires considerable care and judgment. Generally the analysis should result in a reconstruction of the original survey or a “following in the footsteps of the original surveyor”.

Mn/DOT does not certify that found monuments mark the correct location of private boundary corners, but Mn/DOT does certify the monument marking the location of government land corners.

The Manual of Surveying Instructions 1973 prepared by the United States Department of the Interior provides the general practices and rules for the restoration of lost corners and the subdivision of sections.

3-3.0401 Methods For Determining Position of Government Corners

- a. Existing: A corner whose position can be identified by verifying the evidence of the monument, or its accessories, by reference to the description that is contained in the field notes, or where the point can be located by an acceptable supplemental survey record, some physical evidence, or testimony. Even though its physical evidence may have entirely disappeared, a corner will not be regarded as lost if its position can be recovered through the testimony of one or more witnesses who have a dependable knowledge of the original location or other evidence. Refer to: Manual of Surveying Instructions 1973, Chapter 5-5.
- b. Obliterated: A corner at which there are no remaining traces of the monument or its accessories, but whose location has been perpetuated or may be recovered beyond reasonable doubt, by the acts and testimony of the interested land owners, competent surveyors, other qualified local authorities, witnesses, or by some acceptable record evidence. A position that depends upon the use of collateral evidence can be accepted only as duly supported, generally through proper relation of known corners, and agreement with the field notes regarding distances to natural objects, stream crossings, lone trees, and off-line tree blazes, etc., of unquestionable testimony. Refer to Manual of Surveying Instructions 1973, Chapter 5-9.

- c. Lost: A previously established survey corner whose position cannot be recovered beyond reasonable doubt, either from traces of the original position, and whose location can be restored only by reference to one or more inter-dependent corners. Refer to: Manual of Surveying Instructions 1973, Chapter 5-20.

3-3.05 PUBLIC LAND CORNER MONUMENTATION

3-3.0501 *Government Monuments*

- a. U.S. Monument. The U.S. government agencies set various types of monuments to mark corner locations. These monuments range from cast iron with numbers stamped on top to iron pipes with and without caps. If these monuments are found in good condition they can be left as the corner rather than lowering them and placing a Mn/DOT cast iron monument over the top.
- b. State monuments. Most state monuments have been set by the Department of Transportation or the Department of Natural Resources. Mn/DOT sets cast iron monuments at the section and quarter corners. The DNR uses iron pipes with caps. If these monuments are in good condition they may be left in place as the corner monument.
- c. County monuments. There is a wide variety of material used for county monuments. If the in-place monuments are of substantial material, they may be left in-place as the corner monument; otherwise lower the monument and place a Mn/DOT monument on top.

3-3.0502 *Private Land Surveyor Monuments*

Monument types placed by private land surveyors vary. Some surveyors place their registration number on top of the monuments for identification. When these monuments are tied into the DOT control survey and assigned coordinates, usually no other monument is placed. However, in some cases the monument is lowered and a Mn/DOT cast iron monument is placed above. Minnesota Statutes 505.32 prohibits the removal and destruction of in-place corner posts or their accessories.

3-3.0503 *Reference Ties and Witness Posts*

The reference tie sketch should show the natural and cultural features near the monument being referenced, the measurements to the reference points and the general descriptive statement. The sketch should be complete enough so that anyone looking for this can:

- a. Find the general location within 300 ft.
- b. Identify the specific location within 10 ft from the sketch (accuracy in sketching).
- c. Identify the reference points.
- d. Locate or relocate the monument by the ties to ± 0.03 ft.
- e. Verify the monument.

Reference tie sketches require the following:

- a. Name of person making sketch
- b. Date
- c. State Project Number

- d. Section, Township, Range
- e. County
- f. Name of road or railroad appearing on sketch
- g. Approximate distance and direction (odometer) from nearest town, road intersection, farmhouse, etc. Other general location methods, such as identifying the quarter-quarter section can be used.
- h. Monument identification. Give type of monument and relation of top of monument to ground elevation.
- i. Map sketch
 - 1. Show monument location with respect to cultural features, i.e., buildings, roads, railroads, occupation lines, fence lines, etc.
 - 2. Show reference tie locations including: horizontal distance from monument (if slope distance is given, show difference in elevation and direction of slope by arrow and sign); direction from monument to reference point (use 16 points of compass rose, i.e. N, NNE, NE, ENE, E, etc.); and identification of reference point (name, type and relation of top of reference point to ground).

3-4 CERTIFICATE OF LOCATION OF GOVERNMENT CORNERS

The Certificate of Location of Government Corner is the written record of the present condition and the history for the public land survey corner. To be useful for posterity, this document must be properly completed, provide an unquestionable location, and assure the total perpetuation of the government corner when made of public record. A monument without a history is of little value as evidence and a new monument marking the location of a government corner is worthless if it cannot be identified in the future.

According to Minnesota Statutes 160.15, whenever we destroy or obliterate a public land survey marker or monument it is our duty to place new monuments so the corner can be readily located. We must use a specific monument and place it at the proper location. Each land corner monument must have at least two reference monuments. A Certificate of Location, for each land corner, shall be filed with the County Recorder. The Certificate of Location shall contain specific information about the corner. If any information on an existing Certificate of Location changes, a new Certificate of Location must be prepared. Examples of information changes are: ties, monument type or statement of evidence. Any required filing fee shall be paid out of funds set aside for highway purposes.

It is the responsibility of the District Surveyor to provide for the perpetuation of all land corners, relating to Mn/DOT, within the district. The perpetuation will comply with the guidelines indicated in the attached "Instructions for Certificate of Location of Government Corner".

3-4.01 INSTRUCTIONS FOR PREPARATION OF CERTIFICATE OF LOCATION OF GOVERNMENT CORNERS

The Certificate of Location should be a complete document relating to the location, monumentation, perpetuation and history of a corner. If done properly, the need for future surveyors to research the past record evidence will be eliminated. The following outline provides guidelines for preparation of the Certificate of Location.

- a. Corner Index System
 1. Identify corner in section where the corner is the North Quarter, Northeast or East Quarter corners.
 2. Identify corner in the proper section if on standard parallel or correction line.
 3. If a corner is on a county line it should be identified and filed in each county in the proper section.
 4. List section, township, range, principal meridian and county.
- b. Monument
 1. Check the appropriate statement on the Certificate of Location for monument at corner location.
 2. Indicate date of recovery and/or placement of monument.
 3. Describe the monument in detail and give relationship to ground elevation.
 4. If a monument is removed, during construction or for other purposes, explain fully under statement of evidence (on back of page).

- c. Sketch of Reference Ties
 1. Make a minimum of two ties, more if practicable.
 2. Identify the reference points in detail, e.g., nail and disc on S.W. side of (diameter) burr oak, distance above ground.
 3. Reference tie distances are horizontal unless clearly stated on sketch. Show difference in elevation and direction of slope for slope measurements.
 4. Direction of reference point from corner should be given by:
 - A. Point of compass i.e., N, NNE, NE, ENE, E, etc., or
 - B. By a bearing, i.e., N50°E. For bearings indicate on sketch their basis of orientation and accuracy.
 5. Show the improvements in the immediate vicinity such as roads, including name or number, buildings, fences, tree lines, retaining walls, field lines, and their relation to corner.
 6. Indicate Standard Parallel or Correction Line.
- d. Statement of Evidence
 1. Include all record evidence that relates to the history of this corner chronologically beginning with Public Land Survey.
 2. Include all parol evidence and testimony concerning corner location. List name, age, residence, address, job title, and how information was obtained.
 3. Include all information on field search and excavation. Indicate extent and depth of excavation; soil profile characteristics; present and original ground elevations could be added.
 4. Include information on monument found in place. Identify type and size of monument; who, when and how it was placed in addition to a photo. Indicate in statement of evidence if no information is found on the origin or history of monument.
 5. Method used to set lost or obliterated corners must be stated in a short summary with supporting evidence.
 6. When a coordinate value is known, the coordinates may be listed. If the coordinates are enumerated, the reference coordinate system must be indicated.
 7. Analyze all of the information on the document. Indicate the reasons for the decisions made in the form of a summary or conclusion statement.

For examples of the completed form, see Figure 3-4.01A and Figure 3-4.01B.

3-4.02 FILING OF CERTIFICATE OF LOCATION OF GOVERNMENT CORNER

According to Minnesota Statutes 160.15 subd. 4, the surveyor placing and establishing the markers or monuments shall file a Certificate of Location to that effect in the Office of the County Recorder, or the County Surveyor where the county maintains a surveyor's office, in the county wherein the markers or monuments were placed.

Therefore the completed Certificate of Location shall be filed at the following locations:

- a. The County Recorder's Office
- b. The County Surveyor's Office
- c. By the District Surveys Office in Mn/DOT's Electronic Document Management System (EDMS)

Minnesota Statutes 507.093 imposes standards on documents to be recorded with the county recorder or filed with the registrar of titles. Current standards state that:

- a. Document sheet(s) size not to exceed 8.5 inches by 14 inches.
- b. All text shall be printed, typewritten or computer generated in black ink and not smaller than 8-point type.
- c. All documents to be on white paper not less than 20-pound weight with no background color, images or writing.
- d. The first page of the document is to have a 3-inch margin at the top for recording and filing information and no less than a one-half inch margin on each side and the bottom.
- e. The title of the document shall be prominently displayed on the first sheet of the document immediately below the 3 inch recording and filing margin.
- f. Additional document pages shall have no less than a one-half inch margin on top, bottom and each side.

3-4.03 MN/DOT CORNER CERTIFICATE POLICY

For further guidance on this subject see, the Mn/DOT "Certificate of Location Of Government Corner" Policy in APPENDIX B of this manual.

Index No. _____

CERTIFICATE OF LOCATION OF GOVERNMENT CORNER

Northeast Corner of Section 9, Township 149N, Range 34W, 5 P.M.

STATE OF MINNESOTA, County of Beltrami

At the corner location shown on the sketch:
Nov. 2, 1971

On _____ found a Brown quart whiskey bottle, neck down and
vertical, 4.5 feet below surface of old township road.

left monument as found, lowered monument, removed monument (explain)
Nov. 2, 1971

On _____ placed a two 3/4 inch x 24 inch Iron Pins (one on
top the other) directly over bottle. Top of upper pin is 0.3 feet
below surface.

SKETCH OF REFERENCE TIES

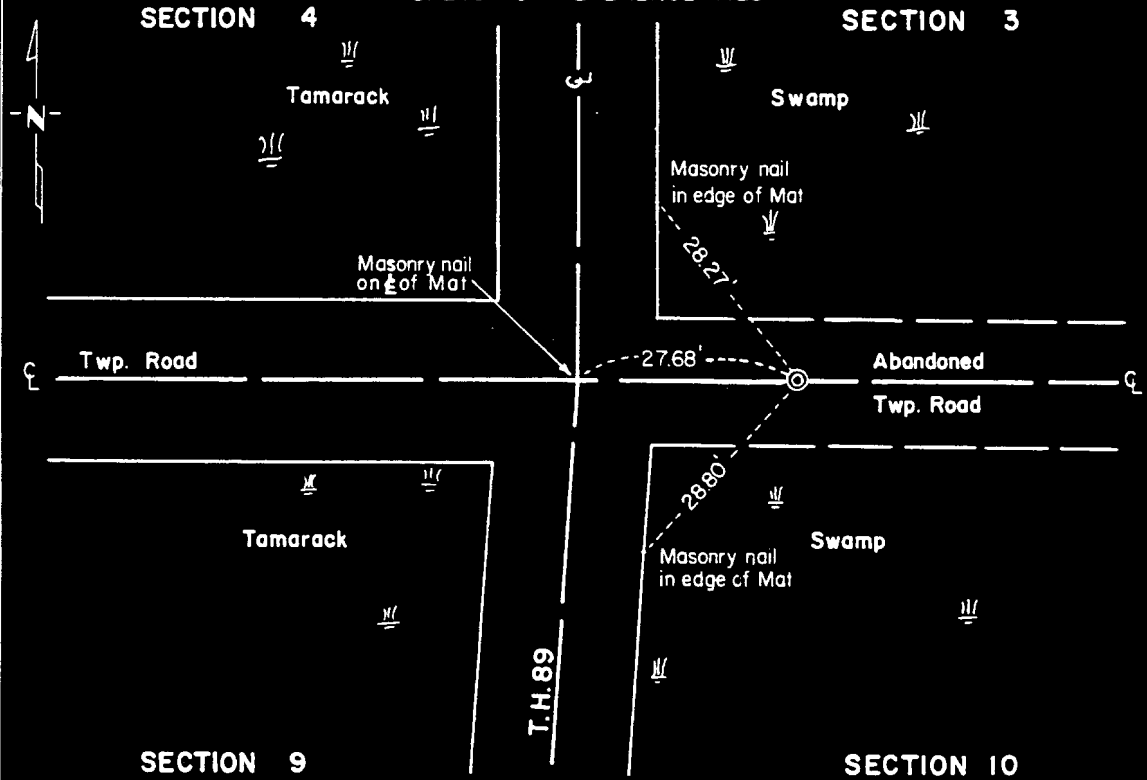

Statement of evidence relative to this corner location is on back of page.

I hereby certify that this document and the data contained herein was prepared by me or under my direct supervision.

John E. Swenson 3-14-74
SIGNATURE DATE

Registration No. 10460

- Land Surveyor, Professional Engineer
- County Surveyor, County Engineer

OFFICE OF THE COUNTY RECORDER
County of Beltrami

I hereby certify that this document was filed in the Co. Recorders office at 4:00 P. M. on the 16th day of April A.D., 19 74

County Recorder Martin R. Sathre

By Ruby A. Butler, Deputy

DOCUMENT NO. 232958

Statement of Evidence: NORTHEAST CORNER OF SECTION 9, T149N, R34W, 5TH P.M.

The original Public Land Survey was run in 1891 and a wood post was placed to mark the corner.

In 1908, Roy K. Bliler, County Surveyor, while conducting a township road survey, found the original corner and perpetuated its location by placing a quart bottle and tamarack post at the original corner location. Bliler also established 2 bearing trees for this corner.

In 1910, Roy K. Bliler, County Surveyor, while conducting a township survey, found his original corner as set in 1908 and the 2 bearing trees in good condition.

In 1914, C.C. Spencer, Deputy County Surveyor, while conducting a township road survey, found and used the original corner location as perpetuated by Roy K. Bliler in his 1908 survey.

In 1919, A.L. Bye R.L.S. #1287, while conducting a State road survey, found Bliler's tamarack post, quarter bottle and 1 bearing tree. A.L. Bye then placed a stone mound and marked 2 new bearing trees.

A 1930 County Road Plat indicates A.L. Bye's bearing trees, original corner, and engineer's stationing to the point.

In 1936, R.D. Sorenson, Minnesota Highway Department Project Engineer and R.L.S. #1166, while conducting a survey for T.H. #89, found A.L. Bye's Corner at the perpetuated original location, established a distance tie to the centerline of T.H. #89 and centerline of a township road running East.

In 1940, the Civilian Conservation Corp ran a lineal survey near the corner, but did not indicate any physical evidence of a monument.

In 1971, the Minnesota Highway Department excavated an area 4.0 feet by 6.0 feet to a depth of 4.5 feet.

Natural ground was reached at a level of 4.0 feet. At 4.5 feet the quart bottle as set by Roy K. Bliler in his 1908 township road survey was found. No other physical evidence of monumentation could be found.

An analysis of record data, compared to field measurements and occupation lines of long standing, places the accepted location for the perpetuation of the original corner, at the quart bottle as set by Roy K. Bliler in his 1908 township road survey.

For recent survey measurements and additional information relative to the corner, contact the Surveys Section, Minnesota Highway Department, Bemidji, Minnesota.

3-5 R/W BASE MAP

The right of way base map is the planimetric map used in the right of way process to the acquisition stage. At the time the district is preparing requests for aerial photography to be used for mapping, a meeting should be held by the district design, survey, and right of way engineers to determine if a new right of way base map will be needed on any projects. A new right of way base map is usually needed when a project requires additional right of way or urban development has occurred.

3-5.01 SPECIFICATIONS

- a. All new right of way base maps will be completed using computer aided design and drafting (CADD). For CADD standards, see the "R/W CADD Mapping Standards & Drafting Details" manual available from the Right of Way Engineer or the Central Office Mapping Group.
- b. The map shall be trimmed to 30in width to fit files. On projects with intersection of major roadways 36in width maps will be acceptable.
- c. The right of way map shall have a borderline 3/4in down from the top and 3/4in up from the bottom of the roll.
- d. 9in shall be left at each end of the roll to the borderlines.
- e. Both ends of the right of way map shall be marked as shown in the Right of Way Manual (Figure A 5-491.103).
- f. An index map shall be at the beginning of each roll. A layout showing the roadway and interchanges for which the right of way map is being prepared shall be shown boldly on the index map.
- g. The right of way map shall be limited to 30 ft.
- h. The centerline of the highway should be positioned as close as possible to midway between the top and bottom of the roll. Match lines should be used to keep the map centered. The match lines should be made at section lines, quarter section lines or on centerlines of dedicated streets.

3-5.02 PREPARATION

When the planimetric map files are received in the district surveys office from the Photogrammetric Unit, the files will have the coordinate grid ticks and the surface physical and cultural features shown on it.

3-5.0201 *Map Content*

The district surveys office should then add the following graphics to the computer graphics files:

- a. Identity of existing roadways by name, number, and/or the government level. Description of the ownership interest of the right of way such as fee, easement, dedication, prescription, and the recorder's document number, if available.
- b. Section corners and quarter section corners. Plot the position by coordinates and show the symbol for the type of monument at this position. The symbol, indicating the government corner, should be shown a short distance away from the actual position. (See Figure C 5-292.620 Mn/DOT Technical Manual)

- c. Section lines, quarter lines and sixteenth lines should be drafted in the graphics file using proper section breakdown methods to establish them. (See Manual of Surveying Instructions 1973)
- d. Plot all property corner monuments found and indicate by symbol the type of monument.
- e. Draft lot, block and other property lines.
- f. Draft all existing public road right of way and railroad right of way with dimensions so that any proposed right of way which will tie into the existing right of way can be computed.
- g. Plot the manholes, catch basins, utility pedestals and valves. The various lines connecting these utility structures should not be shown on the right of way base map.
- h. Plot the culverts but do not indicate type and size on the right of way base map.
- i. Plot any wells (used or unused) located within 20 ft of Mn/DOT right of way.
- j. Plot any underground fuel tanks and sewer systems including septic tanks, outlets and drain fields.

3-5.0202 *Text Annotation*

After the graphics have been placed in the computer files, the annotation (labeling) can be added. In order to have the annotation placed properly and have a legible map, it is important to have the graphics on the map prior to beginning the annotation. Guidelines for the graphics to be annotated on the right of way base map are:

- a. Section, quarter and sixteenth corner symbols along with the coordinate values for the section and quarter corners to three decimal places.
- b. Alignment data (P.I., P.C., P.T., P.O.T. delta angle, tangent length, arc length, radius, and degree of curve. This information should be shown to the nearest 0.01 ft (distances), and the nearest second (angles). Coordinates should be shown for the P.I.s and the P.O.T.s to three decimal places.
- c. Lot, block, subdivision, towns, and corporate limits.
- d. Streets, county roads, township roads, and railroads.
- e. Rivers, streams, county and judicial ditches. Show the name or number and direction of flow.
- f. Buildings. In rural areas the type of structure should be shown. In urban areas the address also should be shown and if a commercial building the name of the establishment.

When the graphics and annotation listed in this section have been completed, the graphics file can be used for plan sheets in detail design, right of way work map (see Right of Way Manual 5-491.107), utilities map (see Surveying and Mapping Manual Section 5-6.0504).

3.6 RIGHT OF WAY STAFF AUTHORIZATION MAP

The Right of Way Staff Authorization Map (see Right of Way Manual 5-491.108) is a print of the right of way work map showing the proposed acquisition including the various types of interests to be acquired, indicated in red. The staff authorization map gives the people who must approve and sign it an opportunity to make recommendations for changes in the right of way before the processing of the parcels for descriptions and appraisals begins. The staff authorization map must be approved and signed by the district and central office personnel.

When the staff authorization map has been approved, the district surveys office should complete their final computations of the plat boundary corners and submit the plat graphics file to Central Office Platting Unit (See Surveying and Mapping Manual Section 3-7.01).

3-7 RIGHT OF WAY PLATS

3-7.01 ACQUISITION PLATS

The acquisition of right of way for highways, both State and County, by reference to a plat of the proposed right of way is authorized by Minnesota Statutes 160.085. This law authorizes the road authority to use the plat as the commissioner's order or county resolution as required by law.

Mn/DOT policy is that all right of way to be acquired shall be by reference to an acquisition plat. Any exception to this policy must be approved by the Director, Office of Land Management.

The plat delineates by courses and distances the right of way access, temporary easements, and other permanent easements, the road authority is acquiring. The plat boundary is also referenced to the PLSS survey by courses and distances. In special cases, the plat may be referenced to block corners of a recorded subdivision plat. Property ownerships and parcels being acquired are shown graphically, the name of the fee owner of the property and the area of each type of interest being acquired from each ownership is shown in tabular form.

The position of one Public Land Survey System corner on the plat is shown with reference to the State Plane/County Coordinate System. The positional tolerance of the boundary points of the plat are stated statistically, i.e., standard deviation.

The numbering of the plats should follow a convention. Plats are numbered with the first two digits being the county number followed by a dash number. The dash number represents the number of prior plats in that specific county.

3-7.0101 Computation of Boundary Corners

Plat boundary corners are computed on a county coordinate system. Basic data on conversion factors, ties to Public Land Survey System lines and corners, and other data will be found in the plat folder or survey report for the project. The following steps outline the computation procedure.

- a. The data needed to compute coordinates of boundary corners are:
 1. A copy of the right of way work map with the construction limits and the proposed right of way.
 2. The coordinate values for the proposed alignment points.
 3. A copy of the PLSS section breakdown sheets.
 4. The mathematical data and legal descriptions on existing state highway alignment. This includes Mn/DOT final certificates, easements, deeds, and coordinates of in-place alignment points.
 5. Data on county right of way from county engineer.
 6. Township road orders filed with township clerk or county auditor.
 7. Data regarding subdivision plats affected by plat boundary, including coordinates of found lot corners.

- b. The number and location of the boundary corners for each plat are determined from the right of way work map. A boundary corner is designated at each point where the boundary of the plat has a deflection and at the beginning and end of curves. Boundary corners are also established at intersections with section and quarter section lines. The method of computation of the coordinates of each boundary corner must be determined by the individual doing the computing. Usually one of the following methods will be used.
 1. Stationing and parallelism with respect to centerline alignment.
 2. Adjacent platting.
 3. PLSS section or subdivision line.
 4. Adjoining right of way boundary.
 5. Selected or scaled coordinate position.
- c. Several rules are given below as guides in numbering boundary corners:
 1. All boundary corners will be assigned a B number.
 2. The boundary corners on the lowest numbered plat will be numbered first. The remaining plats on the project are numbered in consecutive order.
 3. Boundary corners will be numbered clockwise around the plat boundary beginning with B1. B1 is usually in the upper left hand portion of the plat and never common to another plat.
 4. The sequential number of any corner common to two or more plats will be prefixed by the digit to the right of the hyphen of the plat number. If the number to the right of the hyphen is over 100, then the last two digits are used, i.e., B10 of Plat 125 is B2510.
 5. The boundary corner numbering system will bypass any common corners numbered on a previous plat. On subsequent plats, common corners will retain the same previous B corner number.
 6. Numbering of boundary corners on detached areas of right of way to be acquired on a plat will use a continuation of the numbers used on the main body of the plat.
 7. If the numbering of boundary corners is changed in the process of computation, revise the numbering system to be compatible with rules 1 to 6 above.
 8. Section and quarter section corners are not assigned a B number.
- d. The computations of the boundary corners are based on the geometric conditions that control Section 3-7.0101b in this manual. All coordinate and distance computations should be carried to three decimal places. Azimuths should be computed to tenths of a second. Final values of distance and azimuths to be shown on the plat are as follows:

1. Show all distances to nearest 0.01 ft.
 2. Show all azimuths to nearest 1 second and adjusted for intent, if applicable.
 3. Perpendicular azimuths must differ by $90^{\circ}00'00''$.
 4. Parallel lines must have the same (or supplemental) azimuth to nearest second.
 5. The central angle on curves must agree with the difference in azimuths of the tangent lines.
 6. The chord azimuth must agree within the nearest second of half of the central angle, except where the radius of curve is extremely large.
 7. Common lines of abutting plats must agree in distance and azimuth.
 8. The sum of the dimensions to access openings, temporary easements, etc., between boundary points must equal the overall distance between the boundary points.
- e. All values must be checked before data is transferred to the graphics file. These guidelines should be followed:
1. The checker should be someone other than the person who computed the data.
 2. With a computer printout, only the input data and the method used need to be checked.

3-7.0102 Plat Development

Plats depicting the right of way must conform with the uniform standards in the Mn/DOT R/W PLAT STANDARDS AND DRAFTING DETAILS booklet available from the Central Office Platting Unit.

The plat CADD drafting process begins as soon as the Right of Way Authorization Map is approved. To expedite the drafting process the base map graphics file containing section lines, property lines, affected specific easements, and existing right of way must be completed accurately so that this graphics file can be used in preparing the plat file.

The draftsman needs the following to be able to draft the plat:

- a. The scale of plat and the basis of the coordinate system being used.
- b. The section breakdown containing quarter-quarter section, quarter section, and section corner coordinates.
- c. A data file with coordinates for azimuth and distance between boundary corners.
- d. A data file with coordinates for azimuth and distance between section corners and boundary corners on section line.
- e. A data file for right of way boundary curve data.
- f. The work map showing the right of way, access control, and temporary easements to be acquired.

3-7.0103 *Plat Monumentation*

Each plat must have a sufficient number of monuments placed in the ground to perpetuate the plat boundary.

Corners may be identified by:

- a. 50-year monuments. There should be a minimum of four (4) per plat. The locations of these should be selected so they are in an area that will not be disturbed and visible from another 50-year monument. A 50-year monument can be a 1½ in by 30 in iron pipe with an aluminum cap, two inch square by 30 inch unistrut monument, or a 4 in by 20 in cast iron monument with a brass disk insert (see Standard Plates Manual No. 9309).
- b. 25-year monuments. These will mark most of the newly set boundary corners that are not marked by 50-year monuments. A typical 25-year monument is a 3/4 in by 24 in iron pin with an aluminum cap stamped "Mn/DOT".
- c. Previously set monument. These may be any monuments set on adjoining private or public land. Analysis and verification of the monument should be completed under the direction of a licensed land surveyor.
- d. No monument. Areas that will be disturbed during construction should not be monumented. They may, however, be marked for right of way viewing or for the landowner's benefit. Every plat boundary corner need not be marked, even in an undisturbed area, if the corner could easily be placed from an adjoining corner.

All of the monumentation shown on a plat must be placed in the ground before the plat is filed. After the corners are set, an independent check of the positional tolerance is made. A standard deviation of the position for the monumented corners is computed and the result shown in the Survey Standards block of the plat.

3-7.0104 *Final Preparation of Plats*

Once the preliminary plat has been drafted numerous activities must be performed to finalize it for certification. The following steps outline the final preparation procedure:

- a. The Central Office Platting Unit sends a preliminary copy of each plat to the Central Office Description Unit.
- b. The Central Office Platting Unit checks the plat in its entirety following the Mn/DOT R/W Plat Check List. All items must be initialed by the person actually checking that particular item.
- c. The procedure for preparing the official plat and the reproductions can be found in the Mn/DOT R/W Plat Standards and Drafting Details booklet.

3-7.0105 *Certification and Signatures*

Before the plats can be filed, they must be approved by the proper authorities in Mn/DOT as follows:

- a. Have the licensed land surveyor responsible for drafting the plats sign the three (3) positives certifying them as a correct representation of the proposed right of way lines as designated.

- b. Have the Director of the Office of Land Management sign the three (3) positives for certification as the official plat.
- c. Have the Land Surveyor responsible for the field-work sign the three (3) positives for certification as to the monumentation of the plat.

3-7.0106 Reproduction and Distribution

The reproductions of the plats for distribution and recording in county offices are as follows:

- a. County Recorder's Office:
 - 1 - Signed "Official"
 - 1 - Matte film "copy" or 1 - Matte film reduced (11" x 17") copy
- b. County Auditor's Office:
 - 1 - Paper copy (certified)
 - 1 - Copy of the Commissioner's Order (certified)
- c. County Assessor's Office:
 - 1 - Paper copy
- d. County Surveyor's Office (County Engineer's Office if no County Surveyor):
 - 1 - film transparency

The filing information; including the document number assigned by the County Recorder, is placed on the "Mn/DOT ORIGINAL." From this "Mn/DOT ORIGINAL" two full size matte film copies and four 50% reduction paper copies are made for Mn/DOT distribution as follows:

- a. Central Office of Land Management:
 - 1 - Signed "Mn/DOT ORIGINAL"
 - 1 - Matte film for file copy
 - 3 - Paper reductions (Platting Group, Mapping Group and Direct Purchase Unit)
- b. District Survey Office:
 - 1 - Matte film copy
 - 1 - Paper reduction

3-7.0107 Plat Revisions

Once a plat is filed of record in the County Recorder's office, the only way to make revisions or changes affecting the recorded plat are:

- a. File a Certificate of Correction in accordance with Minnesota Statutes 505.174 and 505.175. This is done when the recorded plat contained an error, (e.g., typographical, mathematical, etc.) and the error can be explained within the structure of the Certificate of Correction form available from Central Office Land Surveys Unit.
- b. File an amended plat with a new number and an asterisk following the plat number in the upper right corner of the plat (e.g., MINN. DEPT. OF TRANSPORTATION RIGHT OF WAY PLAT NO. 89-3*). The note explaining the asterisk will be

below the heading of the plat indicating the sections involved by the plat. The explanatory note should indicate what parcels are amended by the revision.

- c. File with the County Recorder a rescinding Commissioner's Order. If a parcel is not needed for highway purposes and is not being acquired, that parcel will be rescinded, vacated or set aside by Commissioner's Order. Note: The original plat is not amended in this case.

Subsequent right of way takings that abut a recorded plat which involve parcel numbers other than those shown on the recorded plat may be handled by filing another plat or by metes and bounds description. If another plat is filed it will not have the asterisk or accompanying explanatory note because it is not considered a revision to the previously recorded plat.

3-7.02 PROPERTY SURVEY MAP

The purpose of this map is to define the right of way boundaries of the acquisition or reconveyance graphically.

3-7.03 MONUMENTATION PLAT

Monumentation plats are produced to graphically depict the boundary lines of the right of way owned or controlled by Mn/DOT. In accordance with Minnesota Statutes 160.14, Mn/DOT is authorized to place monuments that mark and indicate the boundaries of highway right of way. The general procedures can be found in the Mn/DOT Right of Way Manual 5-491.131.

3-8 R/W ACQUISITION BY METES AND BOUNDS DESCRIPTIONS

The land surveying required for any right of way that is to be acquired using a metes and bounds description which includes descriptions referenced to a survey line or centerline should be done to the same standards as right of way that is to be platted. The alignment and land corners should be tied into a horizontal coordinate system. There should be two monumented land corners, one on each side of the intersection of the line being referenced to the land line. These land corners should be in the same section as the property that is being acquired and should have Certificates of Location filed in the appropriate county office. (See Surveying & Mapping Manual Section 3-4.02.)

3-9 FINAL R/W MAP

The final right of way map is used as:

- a. A graphic record of the right of way acquired by Mn/DOT.
- b. A reference for obtaining the files containing information regarding the acquisition of the right of way.
- c. Exhibits to indicate the relationship of the right of way with physical features in the area.

The final right of way map is completed by the LIS and Right of Way Mapping Unit of the Office of Land Management in the Central Office. The final map is prepared by computer-aided drafting (CADD) methods using data from the right of way base map graphics file. The standards and the content for the map are as described in the "R/W CADD Mapping Standards Details" manual available from the Central Office LIS and Right of Way Mapping Unit.

The Central Office LIS and Right of Way Mapping Unit assigns a file number to the map and adds this number to the county right of way index map system.

3-10 SPECIAL SURVEYS

Special surveys are surveys of tracts of land required by Mn/DOT for purposes other than right of way. Three types of these surveys are: site surveys; Registered Land Surveys; and reconveyance surveys. Whenever possible, these special surveys should be tied into the project control system.

3-10.01 SITE SURVEYS

Examples of site surveys include surveys for gravel pits, maintenance sites, rest areas, soil borings, communication towers, etc. Site surveys may require additional information to that necessary for a land survey (e.g. topography, boring location, drainage information, etc.). Any special data needed for a site survey should be included in the request of survey.

3-10.02 REGISTERED LAND SURVEYS

A Registered Land Survey may be required when Mn/DOT plans to acquire registered (Torrens) property. This type of survey may be required in certain counties if the tract of land to be acquired is unplatted registered land and is not a full government subdivision. If a Registered Land Survey is necessary, it must meet the requirements of Minnesota Statutes 508.47.

3-10.03 RECONVEYANCE SURVEYS

Property that is excess or surplus and no longer needed by Mn/DOT may be either:

- a. Transferred to another state agency.
- b. Quit Claim deeded to a political subdivision at no cost if the property is to be used for a public purpose.
- c. Sold to the underlying fee owner or the original owner.
- d. Put up for public auction.

Reconveyances are covered by Minnesota Statutes 161.23, 161.43, and 161.44. When a piece of property has been identified as surplus or excess, a survey may be required to define the new property boundaries for description and identify any structures or easements that may affect the sale of the property.

3-10.0301 Survey of Critical Topography

The survey that is required for a reconveyance should be similar to a site survey which includes all structures, buildings, improvements, walls fences, utilities, etc. to a distance of about 130 feet adjoining the proposed reconveyance area.

3-10.0302 Establish Land Ties

To enable the new right of way line and the property boundaries to be properly tied into the Public Land Survey System (PLSS), a minimum of two land corners should be used. These land corners may be PLSS corners, or recorded plat or lot corners depending upon the boundaries of the proposed reconveyance. If PLSS corners are used, Certificates of Location should be filed for these corners according to Section 3-4.02.

3-10.0303 Establish Line Data For Description

If a new right of way line is to be described and it will be referenced to a centerline, it should be the centerline used for the existing highway.

A field survey should be made to establish the centerline on the ground so the new right of way line is referenced to something that was actually built rather than a planned line, which was never built. The critical topography should be tied into the same centerline as the right of way line to determine if the right of way being retained is sufficient to include the roadway structures.

If the right of way line to be described is not going to be referenced to a centerline and will be described using courses and distances, the district survey office should then:

- a. compute the courses and distances
- b. tie the right of way line into a land line
- c. be sure the computed line leaves any critical topography within the remaining right of way of the trunk highway system.

A drawing of this survey should be produced and forwarded to the district right of way office to be enclosed with the right of way package that is forwarded to Office of Land Management at the Central Office.

3-11 TURNBACKS

Roadways that are no longer needed in the trunk highway system are removed from the system in accordance with Minnesota Statutes 161.16 and 161.24. When a portion of a roadway is to be released from the trunk highway system and the establishment of a new right of way line is required, the district survey office, in cooperation with district right of way and state aid offices, should follow the instructions set out in Section 3-11.01 through Section 3-11.03.

3-11.01 SURVEY OF CRITICAL TOPOGRAPHY

All structures necessary to the roadway that is to remain in the trunk highway system (i.e., drainage structures, retaining walls, fences, utilities, etc.) should be tied into the alignment of a roadway that is to remain in the trunk highway system.

3-11.02 ESTABLISH LAND TIES

To enable the new right of way line to be properly tied into the Public Land Survey, a minimum of two land corners is required. These land corners should straddle the new right of way line that will be described, or reference line used for the new right of way. These corners should be in the same section as the right of way to be released. Certificates of Location will be filed for these corners according to Section 3-4.02.

3-11.03 ESTABLISH LINE DATA FOR DESCRIPTION

If the right of way line to be described is referenced to a centerline, it should be a centerline that is remaining in the trunk highway system, not the centerline of the roadway that is being removed from the trunk highway system.

A field survey should be made to establish the centerline on the ground so the new right of way line is referenced to something that was actually built rather than a planned line, which was never built. The critical topography should be tied into the same centerline as used for the new right of way line to determine if the right of way being retained is sufficient to include the roadway structures.

If the right of way line to be described is not referenced to a centerline, but will be described using courses and distances, the district survey office should then:

- a. compute the courses and distances
- b. tie the R/W line into a land line
- c. be sure the computed line leaves any critical topography within the remaining right of way of the trunk highway system.

3-11.04 TURNBACK AUTHORIZATION MAP

The turnback authorization map is a paper print of the permanent right of way map that indicates the areas proposed to be released by solid yellow shading. Any data collected under 3-11.01 through 3-11.03 should be added to the turnback authorization map. This map offers the people who approve and sign it an opportunity to recommend changes before the release is processed. The turnback authorization map must be approved and signed by district and central office personnel.

3-12 MISCELLANEOUS MARKING OF RIGHT OF WAY BOUNDARIES

The Mn/DOT policy regarding Trunk Highway Right of Way is that right of way occupied and /or monumented represents the property that was viewed, appraised, to which rights were acquired, and is the property that the Department will claim. This policy should be followed for all requests to mark right of way purchased by centerline descriptions.

In the case where the decription of record does not fit the occupied right of way, the Minnesota Department of Transportation will rectify the description of record by the necessary means to make it conform to the right of way as occupied and/or monumented.

For purposes other than platting and large-scale monumentation, the accuracy of the staking and the methods used are governed by the purpose for which the staking is being done (see Section 3-12.01 through Section 3-12.03).

3-12.01 R/W STAKING FOR VIEWING OR APPRAISING

Staking for viewing or appraising is done upon request from the district right of way office. A current right of way map is furnished to the district survey office for guidance in making the survey. Nothing permanent is placed at these temporary corners. They should be placed to a tolerance of ± 1.0 ft (one standard deviation).

3-12.02 R/W STAKING AT THE REQUEST OF ADJOINING PROPERTY OWNERS

Adjoining property owners may request right of way staking for the purpose of ensuring they do not place improvements encroaching upon Mn/DOT property. In this type of staking, usually lath are used but occasionally R/W posts and signs are placed. This may require relocating and re-establishing the centerline used for the purchase of the right of way.

3-12.03 R/W STAKING FOR PRIVATE LAND SURVEYORS

This type of staking is done upon the request of a private land surveyor. The request comes to the district surveys or right of way office. This staking may take one of the following forms:

- a. The procedure required for locating the right of way alignment monuments requires the use of the old notes and ties to recover the alignment. Care should be taken in interpreting the record since the right of way alignment is not always the same as the construction or in-place alignment. For comments relative to re-establishing the right of way centerline see Section 5-3, Alignment, in this manual. Essential points of the right of way centerline are then marked so they can be readily found and used by the land surveyor. These points should be placed to a tolerance of ± 0.1 ft.
- b. In some cases the right of way boundary will be monumented for adjacent surveys such as platting. These surveys must be done under the supervision of a licensed land surveyor. The general procedure is as follows:
 1. Relocate or reset the P.I.s on each side of the property and reestablish the right of way centerline from these points.

2. Offset essential points along the right of way boundary, (e.g., points opposite the beginning and end of curves, jogs in the right of way) and set standard R/W monuments with posts.
 3. Prepare notes on survey for district file.
- c. Provide a coordinate file of control, alignment, and right of way boundary points for staking by the private land surveyor.

CHAPTER 4 - PHOTOGRAMMETRY

- 4-1 INTRODUCTION**
 - 4-1.01 PURPOSE**
 - 4-1.02 ORGANIZATION OF SERVICES**
 - 4-1.0201 Planning Group**
 - 4-1.0202 Mapping Group**
 - 4-1.03 DEFINITIONS**

- 4-2 PRODUCTS AND SERVICES**
 - 4-2.01 INTRODUCTION**
 - 4-2.02 AERIAL PHOTOGRAPHY**
 - 4-2.0201 Vertical Aerial Photography**
 - 4-2.0202 Oblique Aerial Photography**
 - 4-2.03 PHOTOGRAPHIC REPRODUCTION**
 - 4-2.0301 Mn/DOT Photo Lab**
 - 4-2.0302 Contractor Photo Lab**
 - 4-2.0303 Contact Prints**
 - 4-2.0304 Diapositives**
 - 4-2.0305 Photographic Indexes**
 - 4-2.0306 Photo Enlargements**
 - 4-2.0307 Digital Images**
 - 4-2.04 AERIAL MOSAIC**
 - 4-2.0401 Uncontrolled Mosaic**
 - 4-2.0402 Semi-Controlled Mosaic**
 - 4-2.0403 Digital Ortho Mosaic**

- 4-3 AERIAL PHOTOGRAPHY ACQUISITION**
 - 4-3.01 INTRODUCTION**
 - 4-3.02 AERIAL PHOTOGRAPHY USES**
 - 4-3.03 AERIAL PHOTOGRAPHY REQUESTS**
 - 4-3.04 AREAS TO BE PHOTOGRAPHED**
 - 4-3.05 TIME OF PHOTOGRAPHY**
 - 4-3.0501 Spring Flying**
 - 4-3.0502 Fall Flying**

4-3.06 COORDINATION OF PHOTOGRAPHY WITH GROUND TARGETING**4-3.07 PRIORITIES FOR PHOTOGRAPHING PROJECT AREAS****4-3.08 ACCURACY****4-3.0801 Non-Mapping Photography****4-3.0802 Mapping Photography****4-3.0803 Photography Specifications****4-3.09 PHOTOGRAPHIC MATERIALS TO BE DELIVERED****4-4 PHOTGRAMMETRIC MAPPING PROJECT PLANNING****4-4.01 PRE-SURVEY PLANNING****4-4.0101 Control Targets****4-4.0102 Test Targets****4-4.0103 Single Strip - Any Length Horizontal Control Only****4-4.0104 Azimuth Deformation: Suppressed With Horizontal Control****4-4.0105 Single Strip - Any Length Horizontal And Vertical Control****4-4.0106 Bowing Deformation: Suppressed With Vertical Control****4-4.0107 Torsional Deformation: Suppressed With Vertical Control****4-4.0108 Successive Single Strips Connected****4-4.0109 Successive Strips - Offset Overlap****4-4.0110 Block Photography: Horizontal Control Only****4-4.0111 Block Photography: Horizontal And Vertical Control****4-4.0112 Target Material and Placement****4-4.0113 Aerial Target Size****4-4.0114 Target Site****4-4.0115 Target Pickup****4-4.0116 Extra Targets****4-4.02 NON-TARGET CONTROL****4-4.0201 Non-Target Control: Horizontal Only****4-4.0202 Non-Target Control: Horizontal And Vertical****4-4.0203 Possible Problematic Control****4-4.03 PROJECT PLANNING POST FLIGHT SETUP****4-4.0301 Photograph Marking****4-4.0302 Control Point Diagram****4-4.0303 Control Point and Passpoint Numbering****4-4.0304 Control Point Symbols****4-4.0305 Control Point Tabulation Sheets**

4-4.0306 Control Point Survey Data**4-5 AEROTRIANGULATION****4-5.01 INTRODUCTION****4-5.02 MAPPING MODEL****4-5.03 AEROTRIANGULATION PROCEDURE****4-5.04 AEROTRIANGULATION ACCURACIES****4-5.05 AEROTRIANGULATION OUTPUT****4-5.06 AEROTRIANGULATION REPORT****4-5.07 PROJECT RECORD SHEET****4-6 DIGITAL MAP COMPILATION****4-6.01 INTRODUCTION****4-6.02 STEREOPLOTTERS / DIGITAL WORKSTATIONS****4-6.03 MAPPING HARDWARE AND DATA COLLECTION SOFTWARE****4-6.04 MAPPING SCALES****4-6.05 TYPES OF MAPPING****4-6.0501 Planimetric****4-6.0502 Digital Terrain Model (DTM)****4-6.0503 Contours****4-6.06 STANDARD AND REDUCED DETAIL****4-6.0601 Standard Planimetric Detail****4-6.0602 Reduced Planimetric Detail****4-6.07 FILE TYPES****4-6.08 DATUMS, COORDINATE SYSTEMS****4-6.09 MAPPING FILE DESIGN PARAMETERS****4-6.10 REQUIRED FILES****4-6.1001 Planimetric Projects****4-6.1002 DTM Projects****4-6.11 STEREOPLOTTER MODEL SETUP PROCEDURES****4-6.1101 Interior Orientation****4-6.1102 Exterior Orientation****4-6.12 PLANIMETRIC STEREOMODEL SETUP****4-6.13 DTM STEREOMODEL SETUP****4-6.14 PLANIMETRIC FEATURE COMPILATION**

4-6.15 DTM MAP COMPILATION

4-6.1501 Center Point Data

4-6.1502 DTM Feature Compilation

4-7 DIGITAL MAP EDITING

4-7.01 INTRODUCTION

4-7.02 FILE TYPES

4-7.03 FILE SIZES

4-7.04 FILE NAMING CONVENTION

4-7.05 PLANIMETRIC FEATURE EDITING

4-7.06 GRID TICKS

4-7.07 MAPPING INDEX

4-7.08 DTM EDITING PROCEDURES

4-8 MAP ACCURACY

4-8.01 INTRODUCTION

4-8.02 MAP ACCURACY STANDARDS

4-8.03 MAP TESTING PROCEDURES

4-8.04 ACCURACY TESTING ANALYSIS

4-8.05 MAP ACCURACY REPORT

4-9 MAPPING DELIVERY AND ARCHIVING

4-9.01 INTRODUCTION

4-9.02 MAPPING DELIVERY

4-9.0201 Planimetric Projects

4-9.0202 DTM Projects

4-9.03 FILE ARCHIVING

CHAPTER 4 - PHOTOGRAMMETRY

4-1 INTRODUCTION

Chapter 4 - Photogrammetry will acquaint the user with the policies, procedures, products and services of the Mn/DOT Photogrammetric Unit. It discusses the acquisition of aerial photography products, photogrammetric mapping, the procedures by which to obtain these products and the methods and standards used to produce the products and services.

In addition to the material covered in Chapter 4, the reader is referred to the Photogrammetric Products Catalog, the Photo Control Users Manual and the Photogrammetric Digital Mapping Features Symbols and Cells Manual. Copies of these reference materials are located in the Photogrammetric Unit or can be accessed from the Web at the following addresses:

<http://www.olmweb.dot.state.mn.us/photogrammetric/photogrammetry.html>.
<http://www.dot.state.mn.us/tecsup/caes/>

4-1.01 PURPOSE

The Photogrammetric Unit exists to provide Mn/DOT and its staff with those photogrammetric services and data, which will aid and benefit the department in planning, constructing and maintaining transportation facilities. The Photogrammetric Unit maintains staff and equipment capable of gathering, interpreting and extracting data by photogrammetric techniques. Photogrammetric services for which the unit is not equipped or staffed are provided through agreements with photogrammetric contractors.

The importance of photogrammetry for the rapid and reliable accomplishment of engineering and associated surveys is recognized internationally. Photogrammetry is the art, science and technology of obtaining reliable information about physical objects and the environment by recording, measuring and interpreting photographic images.

Products and services provided by the photogrammetric/mapping community play important roles in the study, planning, design and engineering tasks carried out by the department and by consultants. A wide variety of products and services, ranging from an aerial photograph to a complete digital engineering map are available and are often used to improve project development. The most common products and services include: contact prints, photo enlargements, photo mosaics, rectified enlargements, rectified mosaics, digital orthophotos, planimetric maps and topographic maps.

The basis for all the photogrammetrically derived data is the aerial survey project. The aerial survey project is the means by which each physical feature depicted in the aerial photograph (what it is, where it is, and its condition and dimensions) can be identified. Photogrammetry uses precision aerial cameras to photograph desired areas. The images are captured using black-and-white, color or color infrared film. The quality of the photographs depends on a number of factors. These factors can be classified as those related to the quality of the camera and lens, and the general environmental conditions such as cloud cover, foliage, sun angle, haze or smoke. There are no limitations on using aerial surveys for engineering and related work provided the aerial photographs are obtained during a suitable flying season, at the appropriate flight height, and proper photogrammetric methods are used to collect the data.

4-1.02 ORGANIZATION OF SERVICES

The Photogrammetric Unit of the Office of Land Management provides services to Mn/DOT district offices, central office units and the general public. The Photogrammetric Unit is divided into two separate areas, the Planning Group and the Mapping Group to provide quality customer service in their respective areas.

4-1.0201 *Planning Group*

The Planning Group's function is to coordinate the planning and scheduling of photogrammetric activities within the Photogrammetric Unit and with district and central office Design and Surveys. Each spring and fall the Planning Group prepares and coordinates all aerial photography requests from Mn/DOT offices. These requests are transmitted through work orders to aerial photography consultants who fly throughout the state obtaining photography in the desired locations.

The Planning Group is also responsible for maintaining the Photogrammetric Unit film library for internal use and for sale to the general public. Library services consist of processing requests for copies of aerial photography, photographic enlargements, mosaics, quad maps and other hard copy maps located in the Photogrammetric Unit. The Planning Group's library services are also a reference resource for locating other suitable photographic products offered by private or governmental sources.

4-1.0202 **Mapping Group**

The Mapping Group is divided into three areas, each representing a phase in the mapping process. The three areas are:

a. Project Planning and Analytical Aerial Triangulation

Analytical personnel perform these two mapping processes working with district survey files. Projects are set up so that requested areas on the photo index can be translated to digital formats on the computer.

b. Map Compilation

The actual development of the digital map or mosaicing of digital scanned photos is done by this section.

c. Editing, Accuracy Testing and Archiving

Individual map models are merged into workable file sizes. Vertical mapping that requires map accuracy standards is then checked to verify compliance with these set standards.

When the mapping project is complete the districts are sent a notice that the electronic files are stored on a server and can be downloaded from that location. A copy is also archived in the Photogrammetric Unit for future reference.

4-1.03 DEFINITIONS

In order to acquaint the reader with the terminology commonly used in photogrammetry, a list of the more commonly used definitions is printed below.

Aerotriangulation: Term frequently applied to the process of determining X, Y and Z ground coordinates of individual points artificially introduced to extend the control network, and determine the camera's position at time of exposure, based on measurements of known ground points from the photographs.

Analytical Photo Control: Term applied to photo control when it is produced by analytical aerial triangulation methods. This method reduces the number of ground points required compared to conventional photo control.

Block of Photography: Two or more side lapping or intersecting strips of aerial photos

Breaklines: Longitudinal profiles photogrammetrically compiled in contour mapping or DTM mapping to define changes in ground elevation. Usually taken at edge of pavement, shoulder, ditch bottom, top of backslope, and other locations as needed. Breaklines are needed at sharp breaks in the terrain such as drainage areas or near water features.

Center Point Data: A series of points that are tied in the field horizontally and vertically and are used to adjust the elevations in the photogrammetric process on projects where contours, cross-sections, or DTMs are to be compiled. The points are selected randomly at approximately 200 ft intervals along the length of the mapping and near the center of the proposed construction (or center of the flight strip if there is no construction). They are also taken on cross strips of photography. This is not to be confused with a test profile.

Conventional Photo Control: Term applied to photo control when all of it is obtained by ground survey procedures. Requires more ground points than control extended by analytical methods.

Cross Strip: A flight strip that crosses another. Usually used to extend the photo coverage on a crossroad.

Digital Terrain Model (DTM): A process of defining the ground surface in with a series of points and breaklines. The DTM can be done Photogrammetrically or by field survey methods. Software is used to connect these points, forming a network of triangles covering the surface area creating a TIN.

End Lap: The overlap area common to two successive aerial photos in a strip. End lap between successive exposures should average 60%.

Flight Strip: A succession of overlapping aerial photos taken along a single flight line. Flight strips are straight lines; hence many flights may be required to cover a curvilinear section of road.

Geodetic Control: First and second order horizontal and vertical control points.

Geodetic Unit: The unit responsible for establishing and maintaining first and second order control throughout the state.

Horizontal Picture Point: A picture point that is surveyed for horizontal control only. This provides the horizontal position and scale control for mapping.

Image Point: A picture point that is chosen from existing ground based objects after aerial photos are taken. May consist of any well-defined, describable object whose position can be determined and whose image appears on at least two overlapping photos.

Model: The area of a strip between the centers of two successive photos. This is the area on which stereoscopic coverage is available; *i.e., this area is approximately 800 ft on a 1"=250' scale aerial photo.*

Passpoint: A photo control point mechanically or automatically produced in the aerotriangulation process and usually not identifiable on the ground. It is used to extend or bridge the horizontal and vertical control from one photo to the next.

Photo Control: Picture points and center points used to relate the aerial photos to field dimensions in photogrammetry.

Photogrammetric Unit: The unit responsible for making planimetric and topographic maps along with cross-sections and digital terrain models from aerial photographs.

Photogrammetry: The art and science of making accurate measurements from aerial photography. The compilation of mapping from aerial photography using stereoplotters, instruments, or photogrammetric workstations is an example of photogrammetry.

Picture Point: A point that can be identified on the photo and is tied to horizontal and/or vertical control in the field. Picture points are used to control the horizontal and vertical relations on the photos. Examples are targets, poles, manholes.

Side Lap: The overlap area common to two parallel strips of aerial photos. Side lap between parallel strips may range from 25% to 45% and should average 35%.

Stereo Model: The three dimensional image formed by the two photographic images of the same terrain taken from different exposure stations. The stereoscopic area is normally formed by the overlap of two consecutive photographs in a strip.

Target: An artificial picture point that is placed on the ground before aerial photos are taken. Usually consists of a painted cross or strips of material laid to form a cross. Each strip or cross member of the target is called a panel.

Target Layout: The map sent to the district by the Photogrammetric Unit, with the flight lines and proposed target locations shown.

Target Pairs: Two total control picture points, at the wing point positions, left and right of the flight line, that appear on the same model.

Test Cross-Section: A cross-section taken in the field to check the accuracy of the photogrammetric cross-sections, referenced to a computed alignment.

TIN: A three dimensional triangular network that represents the ground. From the triangles legs intercepts can be determined to form a contour or cross-section.

Topographic Map: A map that contains planimetric detail and contour lines.

Total Picture Point: A picture point that is surveyed for both horizontal and vertical control.

Trilap: The overlap area common to three successive aerial photos in a strip.

Vertical Picture Point: A picture point that is surveyed for vertical control only.

Void: An area where ground elevations can not accurately be determined due to being obscured by vegetation, bridge decks, canopies, etc.

Wing Point: A picture point located toward the edge of a strip of photos rather than on the center of the photo strip.

4-2.03 PHOTOGRAPHIC REPRODUCTION

Once the aerial negatives have been exposed, various items can be reproduced from them to suit the needs of most customers. Processing of the reproduction products follows procedures similar to film processing except that it can be carried out under safe light conditions rather than complete darkness. The following two sources are available to provide these various items to internal Mn/DOT customers:

4-2.0301 *Mn/DOT Photo Lab*

- a. Maximum enlargement size: 40 in x 40 in.
- b. Maximum enlargement ratio: 6X.
- c. Materials: paper or film positive.
- d. Quick turnaround time.
- e. Low cost.

4-2.0302 *Contractor Photo Lab*

- a. Maximum enlargement size: 40 in x 72 in.
- b. Maximum enlargement ratio: 25X.
- c. Materials: paper or film positives, 85 and 133 line screens, film positives can be printed on clear or matte mylar finish.
- d. Average of 3-4 week turnaround time.
- e. 2 year contract pricing.

4-2.0303 *Contact Prints*

A contact print is a direct positive copy developed at the same scale as the aerial negative. These prints measure 9 in x 9 in.

4-2.0304 *Diapositives*

A diapositive, also referred to as a film plate, are positive images that are contact printed onto transparent film the same size as the original negatives. These film plates are used in the stereoplotters to produce digital mapping.

4-2.0305 *Photographic Indexes*

Photographic indexes are photo reproductions of flight strips. The scale of photo indexes varies with the scale of the photography. A typical scale would be 1" = 1000'. Photo indexes measure 20 in x 24 in. An index sheet does not contain projects for more than one district. The photo indexes are also available as an electronic digital file and can be accessed through Mn/Dot's Electronic Document Management System (EDMS).

4-2.0306 *Photo Enlargements*

A photo enlargement is a print of an original aerial negative produced at a larger size and scale. These enlargements can be made of whole or partial photo images of the original aerial negative.

4-2.0307 *Digital Images*

A digital image is an electronic raster file of the aerial photograph. The Photogrammetric Unit is in possession of a high quality Photogrammetric Scanner that is capable of scanning the aerial film negatives to produce a digital image of any photographic exposure. Resolution of the image can be customized to any pixel size down to 12.5 micron (2032 DPI). Compression and embedded overview options are available. Digital images can be enlarged or reduced to any size, or warped with software to loosely fit control.

4-2.04 AERIAL MOSAIC

An aerial mosaic is an assemblage of two or more individual overlapping aerial photographs to form a single continuous picture of an area. Mosaics are produced on digital workstations from scanned photography and are no longer done by photographic processes. All mosaics are produced digitally and may be geo-referenced depended upon the type of mosaic. Mosaics are divided into three categories as follows:

4-2.0401 *Uncontrolled Mosaic*

An uncontrolled mosaic is made from two or more photos that have not been corrected. Uncontrolled mosaics have all the distortions associated with a regular photograph plus the distortions inherent between successive photographs. These mosaics are used for photos indexes, design investigation tools, report displays, and plan sheets.

4-2.0402 *Semi-Controlled Mosaic*

A semi-controlled mosaic is made from photos that have been at least partially corrected for variances between exposures. A USGS quadrangle map is the primary basis of control. Semi-controlled mosaics are commonly used for plan and right-of-way sheets, and other products from which scaled dimensions are expected to be semi-accurate.

4-2.0403 *Ortho Mosaic*

A digital ortho mosaic provides an image that is essentially as positionally accurate as a map. The first step in producing a digital ortho mosaic is to scan the film of the desired photographs into a digital format. The second step is to create an analytical solution based on field control. Highly accurate products require control similar to what is needed to produce mapping. The third step is to create a DTM model throughout the desired area to drape the scanned image over. The fourth and final step is to merge all of the data to create the digital ortho mosaic.

4-3 AERIAL PHOTOGRAPHY ACQUISITION

4-3.01 INTRODUCTION

Pre-flight planning is critical to the acquisition of all aerial photography. The requirements outlined in this section are necessary for the timely delivery of all desired photographic products.

4-3.02 AERIAL PHOTOGRAPHY USES

Aerial photographs can be utilized in both planimetric and topographic mapping as well as photo interpretation or image analysis. Some of the more common uses are listed below:

Non-Mapping Uses

- a. Exhibits at public meetings.
- b. Exhibits in reports and legal documents.
- c. Photo record of construction areas.
- d. Route studies.
- e. Appraisals of property.
- f. Airport updates.
- g. Facilities management.
- h. Wetland inventory.

Mapping Uses

- a. Planimetric (topography).
- b. Digital Terrain Models (DTM's).
- c. Contours generated from the DTM.
- d. Cross-sections generated from the DTM.

4-3.03 AERIAL PHOTOGRAPHY REQUESTS

Aerial photography projects for mapping and non-mapping purposes are discussed at flying meetings which occur prior to the two flying seasons each year. The seasonal flying meetings are scheduled with each district and interested central office divisions. The information shared at these meetings includes the areas to be photographed, the purpose of the photography and the scheduling of any existing mapping projects. Requests for photography must be made within a couple of weeks after these meetings in order to get the targets down, and the contract for the photography written and signed, prior to the flying season.

There are two flying seasons. In the spring after the snow has melted, but before the trees bud out, and in the fall after the tree leaves have dropped, but before snow covers the ground. Typically these dates are between March 15 to May 15 for the spring season and October 15 to December 15 for the fall season.. There may be other times that photography is needed other than during the normal flying seasons, in these instances the contractor will be requested to fly projects at a negotiated price.

4-3.04 AREAS TO BE PHOTOGRAPHED

Each request for photographic coverage requires a "Request For Aerial Photography" form (Figure 4-3.04.) and an area map. The anticipated beginning, end and side limits of the area to be photographed must be clearly indicated. The area map will normally be a U.S. Geological Survey (USGS) 7-½ minute quadrangle map, or the exported electronic route file from the MapTech Software . Mapping and non-mapping areas are to be clearly marked.

The Photogrammetric Planning Group marks the proposed centerline of each flight on a USGS quadrangle map or MapTech file. This information is then provided to the Contractor along with the work order for flying the project.

4-3.05 TIME OF PHOTOGRAPHY

Photography shall be undertaken only when the lighting and weather conditions are such that acceptable negatives can be produced. In general, photo flights are taken when the angle of the sun is greater than 30 degrees to avoid long dark shadows and between the time period 3 hours after sunrise and 3 hours before sunset. Other seasonal guidelines, listed below, are used to determine the optimal time of photography.

4-3.0501 Spring Flying

The following conditions are required to obtain acceptable aerial photography in the spring:

- a. Snow coverage gone, including ditches.
- b. Ground water gone, including most ditches.
- c. Vegetation not yet leafed out to obscure the ground.
- d. Flying area free of clouds.
- e. Wind conditions no worse than calm to moderate.

4-3.0502 Fall Flying

The following conditions are required to obtain acceptable aerial photography in the fall:

- a. Vegetation or ground cover has died back.
- b. Trees have shed leaves to a large degree.
- c. Most areas are not snow covered.
- d. Flying area free of clouds.
- e. Wind conditions no worse than calm to moderate.

Adverse conditions in any combination of these situations can degrade the quality of the photographic image, which reduces the mapping quality and increases the time to deliver the final mapping project.

4-3.06 COORDINATION OF PHOTOGRAPHY WITH GROUND TARGETING

A target pattern will be drawn on the flight lines for all mapping projects. All contractor photographic operations must be coordinated with the district's placing of targets on the ground in order to minimize the time between these two operations.

4-3.07 PRIORITIES FOR PHOTOGRAPHING PROJECT AREAS

The districts surveys unit will be responsible for prioritizing all requests for aerial photography within the districts boundaries. This will ensure that the highest priority projects for the districts will be flown first in case weather conditions or vegetation leafing out causes the flying season to end before all projects are flown.

4-3.08 ACCURACY

Photography will be checked for accuracy by the Photogrammetric Planning Group in the following manner:

4-3.0801 Non-Mapping Photography

Non-mapping photography will be checked on every third flight strip. If errors are found additional strips will be checked. Districts may be asked about acceptability of photography with discrepancies.

4-3.0802 Mapping Photography

Mapping photography will be checked on every flight strip. If errors are found, the photography contractor will be required to re-fly any flight strips in which discrepancies have been found if time and field conditions permit a reflight. Substandard photography may be used for mapping if the errors or voids can be compensated for with an acceptable amount of extra field survey work.

4-3.0803 Photography Specifications

All photography flown for Mn/DOT will be analyzed using a series of checks to determine if the photography is meeting our aerial photography specifications. Our specifications can be found at the following web address <http://www.dot.state.mn.us/surveying/Photo/photospecs.html>. The results of the checking will be recorded on the "Photography Checklist Form" (Figure 4-3.0803A).

"Flight Inconsistencies", Figure 4-3.0803B, contains pictures to assist in visualizing some of the checklist items.

- a. End of strip coverage length, stereo coverage at selected ends.
- b. Center of flight line (course), must be within 10% of flight height.
- c. Scale of photography ($\pm 8\%$).

- d. Crab: camera axis not in alignment with direction of flight, 5 degree maximum allowed.
- e. Tilt: wing tips not level, 4 degree maximum allowed.
- f. Tip: aircraft nose-tail not level, determined by scale and end lap check.
- g. End Lap: consecutive photo overlap is to be 60% ($\pm 5\%$).
- h. Side Lap: parallel flights 35% ($\pm 10\%$).
- i. Photo Quality
 - 1. Leaf condition: degree to which ground is obscured.
 - 2. Moisture: degree to which ground is obscured.
 - 3. Shadow: note length of shadow and degree of contrast.
 - 4. Fiducials: note clarity of side and corner exposure markers.

4-3.09 PHOTOGRAPHIC MATERIALS TO BE DELIVERED

The photogrammetric unit receives from the Contractor by Work Order:

- a. Photos, 9 in x 9 in contact prints (1 complete set for non mapping projects, 2 complete sets for mapping projects).
- b. Indexes, photo reproductions of flight strips (3 each hard copy).
- c. Digital file of index sheet containing digital image of flight lines and legend.
- d. Photo negatives on rolls stored in film cans.

4-4 PHOTGRAMMETRIC MAPPING PROJECT PLANNING

4-4.01 PRE-SURVEY PLANNING

Photogrammetric mapping project planning begins with an aerial photography request submitted to the Photogrammetric Unit. Upon receiving this request, flight lines will be placed by the Planning Group under the guidance of the Mapping Group Supervisor to obtain the desired mapping area while utilizing topographical features in which to locate targets on.

If existing photography does not have control point targets, consideration should be given to re-flying the proposed mapping area after control targets are set. Photogrammetric mapping based on targeted control points will result in higher mapping accuracies and require 30 to 50 percent less processing than non-targeted projects.

4-4.0101 Control Targets

The recommendation to use targets for control points on photogrammetric mapping is one of the results of extensive research into test data. This test data is available through the Mn/DOT Library or the Mn/DOT Photogrammetric Unit. A series of Federal Highway Administration (FHWA) demonstration projects were conducted with the cooperation and involvement of many state highway agencies. The projects reviewed demonstrated the advantage of using analytical triangulation to reduce the amount of field control survey work.

The FHWA demonstration projects showed a 30 to 50 percent timesavings in photogrammetric mapping procedures using analytical triangulation. The use of targets for control points showed a significant decrease in point misidentification errors and an increase in overall accuracies of point coordinate positioning. Non-target image control points were found to have a high potential for misidentification and too often present poor image measuring characteristics on the diapositive material used for processing data.

Control targets are widely recognized as being the most accurate method of producing an analytical extension of photo control data for photogrammetric mapping projects. A systematic pattern of correctly constructed and properly placed targets will usually result in a one-pass "analytical solution" computation with an excellent ratio or precision. A control target placed on level ground and visible on at least two consecutive photographs will eliminate the more common problems of misidentified photo control points, hard to describe objects and locations, or obscured photographic image points. A good target will not require companion points for verification and will allow a more confident bridging of mapping models, both horizontally and vertically, resulting in a significant reduction in the total number of photo control points required and the time needed to process the data.

The accuracy of an analytical solution is primarily dependent on the repeatability of measurements made at the precise x, y and z coordinates of a point visible from different observation angles. The exact center of a well positioned target can be measured from all angles. Most photographic image points, visible on two or more photos will require some degree of estimating on the part of the photogrammetric technician. As most photogrammetric measurements are in microns (one millionth of a meter) with an accuracy requirement of plus or minus three to ten microns, any ambiguity in the precise center of the photo control point will be reflected in the final accuracy of the analytical solution values from which the photogrammetric mapping measurements are derived.

Reducing the field photo control points to the minimum number of points required to process an analytical solution can only be attempted when all control points are targets. If targets are incorrectly positioned, lost before the flying or survey work is done, or fail to appear on the photos because the aircraft drifted off the selected flight path, extra photo image control points will be needed.

The usual ratio of targets to image points will be one target replaced by two image points. If consecutive targets are lost, additional photo image points will be required, usually at more than a two for one ratio.

With an all-target control pattern, as many as seven mapping models can be horizontally bridged and up to three mapping models can be bridged vertically. Vertical bridging will require the upper and lower one-third of the photographic strip to be considered independently. Targets placed in the wing point positions of every other model alternating between the upper and lower one-third bands of the strip will result in a target occurring in every other mapping model of the strip and every fourth model in either the upper or lower one-third bands of the strip.

While a photo control target project will require less time and effort during the field photo control survey, more time and effort will be required during the photo flying seasons. Targets must be established in the proper locations. If the proper location is an area in which the target will be destroyed by farming, or the target will be objectionable to the general public, the coordinates of the target must be determined and tied to a temporary or permanent protected point at the time the target is established.

All targets must be carefully marked on the quadrangle map furnished and carefully referenced with "swing ties" to enough local objects to render the target recoverable. Ties are to be made to PK nails set in bituminous or spikes set in the center of the target panels, or, if necessary, to marks chiseled in concrete. Painted targets usually remain visible for a long time but may be lost to traffic wear or resurfacing before the mapping request is initiated. A lost horizontal control target may mean that photo image horizontal control is not possible. Additional analytical control models may be required or in some cases mapping in the field may be the only solution.

All photo control points are identified by unique point number. This number must be all numeric. The photographic exposure number will not be available when the targets are being set so the targets will be numbered consecutively starting with number "601" and continuing until the last target for the project is set.

Upon notification of the completion and acceptance of the aerial photography, all target panels on private property are to be picked up, swing ties made or checked and the numbering sequence verified between the quadrangle map on which the target sites are noted and the listing of local or swing ties. Target pattern layout maps and target tie lists are to be submitted the Photogrammetric Unit for use in preparing the photo control project when the mapping request is made.

Distances between targets in a control target layout are determined by the scale of the photography ordered. Wing points are left and right of the flight path centerline. Centerline points are usually set where needed to transfer from one flight strip to another or set as extra data points, such as, alignment points, traverse stations or land ties.

Target Pattern Example

1"=250' Photography

Wing Point = Photo Scale x 3 ft = 750 ft ±150 ft

Mapping Model = Photo Scale x 3.2 ft = 800 ft. (Approximate or Average)

3 Model Bridge = 4 Models x 800 ft = 3200 ft Maximum Between Wing Points

7 Model Bridge = 8 Models x 800 ft = 6400 ft Maximum Between Horizontal Points

15 Model Bridge = 16 Models x 800 ft = 12,800 ft Maximum Between Target Pairs

Alternate Vertical = 2 Models x 800 ft = 1,600 ft Maximum Between Consecutive Targets

1"=500' Photography:

Double All 1"=250' Scale Target Pattern Measurements

For Any Scale Photography Scale (PS):

Wing Point = PS x 3 ft (±20%)

Mapping Model Width= PS x 3.2 ft (Approximate Average)

3 Model Bridge = PS x 3.2 ft x 4 Models

7 Model Bridge = PS x 3.2 ft x 8 Models

15 Model Bridge = PS x 3.2 ft x 16 Models

Alternate Vertical = PS x 3.2 ft x 2 Models

4-4.0102 Test Targets

Each strip of photography intended for an analytical solution and photogrammetric mapping must be tested for accuracy. A strip of photography is tested by comparing a field survey measured control point against the analytical solution computed coordinates for the same point. If a target control pattern is set up with the minimum number of control points possible and no extra points are measured during the field survey, no points can be withheld from the analytical solution for test purposes.

Each flight strip being targeted for photogrammetric mapping must have one extra target set near the middle of the flight strip. The test target can be set at a convenient site, usually at a point for which coordinates will be determined during the survey for some other purpose. Extra targets can be set at alignment points, land corners, land corner tie points or permanent survey monuments.

While only one extra target is required for test purposes, any additional targets can be of help if computation problems are encountered. See Figure 4-4.0105 for location of test targets.

4-4.0103 Single Strip - Any Length Horizontal Control Only (Figure 4-4.0103)

The minimum length of a strip of photography intended for photogrammetric mapping is determined by the photographic coverage requested. In some instances, it will be necessary to extend the ends of the flight line to reach areas where photo control can be established. It is inadvisable to begin or end a strip of photography in a heavily wooded area or in an extensive swamp. The maximum length of a strip of photography intended for photogrammetric mapping is determined by locating the first acceptable control point area in which targets can be established or in which image points will be available. The control point pattern must be in the same model as the beginning and ending mapping model. If the mapping limits cannot be defined prior to setting up the target pattern, the entire photographic strip must be controlled.

Horizontal control for a strip of photography will require two wing point targets in the first and last mapping model of the strip with one additional target near the center of strip for test purposes. If the strip is more than seven mapping models but less than fifteen mapping models, the test target must occur so that no more than seven mapping models are being bridged in either direction.

There must be no more than fifteen mapping models between pairs of targets set in wing point positions of the same model. A strip of twenty-five mapping models will require pairs of wing point targets in models, 1, 10 to 15 and 25. Additional single targets must occur at or near mapping models 6 and 18.

For a photographic scale of $1''=250'$, the maximum distance between pairs of targets will be 12,800 ft. A common target pattern would result in pairs of targets 2 miles apart with a test target set near the 1 mile mark between the pairs. If the strip length exceeds the 12,800 ft maximum, an additional pair of wing point targets must be set, creating convenient segments of nearly equal length. Each strip segment should have two targets near the center of the segment one to be used for control and the other to be used for test purposes.

If a "planimetric mapping only" request cannot be verified prior to the spring-fall flying, the target pattern must be set up to include vertical control targets. Elevations will be required on all of the horizontal control targets and many additional targets for "vertical control only" will be needed.

**4-4.0104 Azimuth Deformation: Suppressed With Horizontal Control
(Figure 4-4.0104)**

Horizontal control points placed in pairs on opposite sides of the flight path center are needed to establish the proper base line measurements for a triangulation computation. Horizontal control points must not span more than seven models along the flight strip. Pairs of targets on opposite sides of the flight strip must set as to control not more than fifteen stereo models.

*4-4.0105 Single Strip - Any Length Horizontal And Vertical Control
(Figure 4-4.0105)*

The horizontal control pattern will remain the same as for horizontal control only. The horizontal control targets will require vertical control or "Z" coordinate positions and the target will become a total control point.

A vertical control pattern will require a target in every other model, alternating between the upper one-third band of the photo strip and the lower one-third band of the photo strip. If the scale of the photography is 1"=250', a target should appear every 1,600 ft along the photographic strip alternating between the upper and lower wing point positions. This will mean that along either the upper or lower one-third band of the photo strip a target will appear at no more than 3,200 ft. intervals.

The upper and lower one-third bands of the strip must be measured independently. Each band adheres to the 3,200 ft maximum distance between targets. The targets can be set as frequently as convenient but must not exceed the 3,200 ft limitation between left wing points or 3,200 ft between right wing points.

*4-4.0106 Bowing Deformation: Suppressed With Vertical Control
(Figure 4-4.0106)*

Bowing deformation is caused by using only pairs of targets in the wing point positions spanning to long of an interval between them. Vertical control points placed along the flight strip in either center or wing point positions will have about the same effect on bowing deformation. A vertical control point placed at three model intervals will usually control bowing deformation by holding the deformation down. A three model interval is determined by multiplying the photo scale 3.2 ft for an average model span, times three models, plus or minus 20 percent. Vertical control points placed at two model intervals will adequately control bowing deformation.

*4-4.0107 Torsional Deformation: Suppressed With Vertical Control
(Figure 4-4.0107)*

Torsional deformation is a deformation that occurs as a rotation along the x-axis of the flight strip. This deformation is greatest at the ends of the strips if sufficient control is not established. Vertical control points placed along the center of the flight strip will have limited effect on torsional deformation. Vertical control points placed in wing point positions will have maximum effect on torsional deformation. A wing point position is determined by multiplying the photo scale times 3 and measuring perpendicularly left or right of the center of the flight path the indicated distance plus or minus 20 percent.

4.4.0108 Successive Single Strips Connected (Figure 4-4.0108)

Each single strip of photography will be independently formed into an analytical solution and refined to the required degree of accuracy. In most cases, some part of the previous strip will become the beginning control for the next consecutive strip. Any number of strips can be formed in this manner, with each succeeding strip computation based on, or connected to, the previous strip. When all of the strips have been satisfactorily computed, the resulting data will be entered into a final computation designed to distribute any remaining error among a greater area.

Setting targets for a successive strip project requires each strip to be controlled in the same pattern as a single strip project. Targets should be set in an area that will be common to the end model of one strip and the beginning model of the next strip. These targets will reduce the amount of control needed and create a strong tie between strips.

Mapping models cannot be established until the photography is available. To insure the proper target control in the connecting areas between strips, a cluster of targets should be established. The last analytical model of one strip and the first analytical model of the next strip must each have targets in the wing point positions. It may be necessary to

control models that extend beyond the mapping limits in order to create a stronger tie between consecutive strips of photography.

4-4.0109 Successive Strips - Offset Overlap (Figure 4-4.0109)

It may be necessary to establish targets to control successive strips for which the flight lines will not intersect. Flight lines may be set up to have an overlap area occur between parallel strips. The end models of one strip will have an area of common photo image in the beginning models of the next consecutive strip. At some point in the common area, mapping limits will have to be connected from the end mapping model of one strip to the beginning mapping model of the next strip. If targets are located in the correct position of the overlap models, only three targets will be needed. Proper targeting of the overlaps area will usually require a series of three targets set at 500 ft to 800 ft intervals midway between the parallel section of the two flights. Additional targets should be set in the outer wing point positions of each flight, opposite the targets set in common flight area.

4-4.0110 Block Photography, Horizontal Control Only (Figure 4-4.0110)

The most desirable control point pattern for block photography is a perimeter control pattern. Any measurable point that falls within the perimeter control point pattern will be defined to the same degree of accuracy attained by the control survey. The entire perimeter of the block must be accessible.

The area can be extended to include public roads or private land to which access is permitted. The first strip of photography can occur at the top or bottom of the block. The first model of the strip must be at the left end of the strip and must have two control point targets in wing point positions. The end or right hand model of the first strip must also have two control point targets in wing point positions. Additional targets in the first strip between end models should be set to occur at no more than three model intervals. A three model interval is determined by multiplying the photo scale times 3.2 ft, times 3 models.

If the photo scale is 1:3000 (1" = 250'):

Use $250 \text{ ft} \times 3.2 = 800 \text{ ft} \times 3 \text{ models} = 2400 \text{ ft}$ between targets.

Any number of photo strips can occur between the first and last strips of the block of photography. Each of the inner strips of photos should have at least one control point target in the first and last model of the strip. The intended side-lap between parallel flight strips is thirty per cent of the photo scale with twenty to forty five percent considered acceptable.

$250 \text{ ft} \times (9 \text{ in photo} = 2,250 \text{ ft by } 2,250 \text{ ft coverage}$
 $30\% \times 2,250 \text{ ft} = 675 \text{ ft side-lap}$
 $2,250 \text{ ft} - 675 \text{ ft} = 1,575 \text{ ft between flight lines.}$

For the last strip in the block of photography the control point requirements are the same as the first, two wing point control targets in the first and last model of the strip and additional control targets at no more than three model intervals along the strip.

4-4.0111 Block Photography, Horizontal And Vertical Control (Figure 4-4.0111)

The horizontal control requirements for block photography with vertical control added, will remain the same as for "Horizontal Control Only". The perimeter control pattern will supply all of the necessary horizontal control. Each of the horizontal control points

will also be measured vertically and becomes a total control point. The first and last strip of the block of photography will also be controlled with the total control points. The first and last model of each of the interior strips will be controlled with total control points. Additional vertical control only targets will be required in the interior of the block. No segment of any of the interior strips can have more than three models bridged between vertical control points. Each of the interior strips should have one target placed near the center of the strip for test purposes.

For a 3 Model Bridge

Photo Scale X Model Width X model bridge +1 = Maximum distance between targets

If the photo scale is 1"=250':

250 ft x 3.2 ft = 800 ft. x 3+1 Models = 3,200 ft

4-4.0112 Target Material and Placement

Targets are the result of two panels that are formed into a cross and the exact center of the target is marked with a nail, iron pin or coordinate position to insure the target location can be repositioned if the target itself is lost before the photo control traverse can be measured.

Most targets will be painted targets, either painted directly on a roadway or similar paved surface, or painted boards set with a pin or nail set in fields, entrances, or open areas of woods. A light flexible white material such as Tyvek house wrap may also be used in fields but it must be securely fastened down so it lays flat. Contrast between the target and the background is an important consideration. White paint on new concrete will probably result in a target that is very difficult to see. Black paint on new concrete may be a better choice. White paint on blacktop usually results in a very clear target. Do not place a target panel over or parallel to existing paint stripes. To paint a centerline target, turn the target panel 45 degrees from the centerline stripe. A good target background can be achieved by placing the painted board target on a square sheet of non-reflective black material. Not only does the black material create the proper background but will also absorb heat from the sun to melt frost or a light snow cover that may occur overnight and obscure the white target outline.

4-4.0113 Aerial Target Size

The target size is proportional to the photo scale of the photography.

Use the following formula to compute the size of the required targets:

Width = Sp * 0.002 in feet.

Where Sp is the Scale of the photo

Length = 10 * W in feet.

Where W is the Width of the target computed from above.

On Mn/DOT projects flown for design type accuracies the photo scale is typically 1" = 250'

If the photo scale is 1" = 250': (Figure 4-4.0113)

Width = 250 * 0.002 which computes to 0.5 feet.

Length = 10 * 0.5 which computes to 5.0 feet.

This formula for target size is based on the textbook **AERIAL MAPPING** by Edgar Falkner, 1995.

If the terrain or area is such that the size of the targets using the above formula would be difficult or impractical to place call Mn/DOT's Photogrammetric Unit to be advised on alternative sizes or configurations for the targets.

4-4.0014 Target Site

The general location of the target is determined by the mapping limits and the target pattern. After the general location of the target is arrived at, the specific target site must be selected. Usually the specific location can be adjusted about 300 ft back and forth along the flight line and about 150 ft towards or away from the flight line for the typical Mn/DOT design mapping type flight. The area selected should be reasonably level or on a constant slope, free of brush, trees, and high grass, and an area where the center of the target can be put flush with the ground surface. Tall objects such as buildings, trees or other obstructions should be far enough way to afford an open cone of visibility of about 45 degrees skyward, in all directions. Most photography will be flown in the mid-morning or mid-afternoon hours. Do not select a site that will be in shadow during those times.

After the requirements of the control pattern are satisfied, additional targets can be set at the discretion of the District Surveys. Additional targets can be set at any point for which a position will be computed as part of the project. These points can be for alignment, land ties, traverse or triangulation stations or any points unique to that particular project.

4-4.0115 Target Pickup

The District Surveys Office should Unit authorizes the aerial photography consultant to photograph the mapping project when all targets have been set and conditions (such as snow cover, leaf drop, and flooding) are good. A project will usually be photographed on the first acceptable day after authorization. Each day's flying will usually be checked for accuracy and coverage on the day after the photography was obtained.

If the photography is acceptable and no re-flights are required, the Photogrammetric Unit will be notified by the contractor. The Photogrammetric Unit will then notify the proper contact person in the District Surveys Office and authorize the pick-up of the temporary targets.

The following information or conditions must be noted at each target site at the time of pick up:

- a. Was a marker set at the center of each target? If not, a spike, iron pin, or other marker must be set at this time. If the survey work was already done and coordinates have been obtained for the target the marker can be pulled if it falls in an area where it may be a hazard (i.e. farm field).
- b. Is the marker under the center of the target? If not, record the distance and direction of offset from target center.
- c. Is the target site in the area of cultivation or construction? If so, has the proper transfer of the horizontal and/or vertical position to a safe and recoverable position been accomplished?

- d. Does the center of the target match immediate ground surface? If not, record the difference in elevation.
- e. Were local ties measured to nearby objects such as fence lines, trees, poles, etc.? If not, measure local ties before target is removed.
- f. Visit the site of targets not being picked up. Note all target conditions and local ties for these targets.

Return the following data to the Photogrammetric Unit as part of the Project Planning Package.

- a. Complete listing of target condition when picked-up and local ties.
- b. Target location map with exact location noted and numbered to correspond with target condition listing.
- c. All target coordinate data, both horizontal and vertical. If offsets were involved the offset should be added to the coordinates to give the Photogrammetric Unit the exact X,Y, Z coordinate of the targets center.

4-4.0116 *Extra Targets*

All permanent survey points occurring within 1000 ft of the photographic flight line should be considered for paneling as extra targets. Extra targets can be of great value to problem solving during the analytical solution process. An extra target may mean that a project does not have to be returned to the field for additional survey work. An extra target can be placed anywhere it is convenient. Targets placed over triangulation stations, traverse stations, alignment points or at land corner tie points will not require additional survey work as the horizontal position of the point will be required for the normal survey data, whether it is targeted or not. A bench mark monument can serve as a good vertical control target and very little extra effort is needed to make the monument a total control target.

In most instances, if an extra target falls within 300 ft of a photo control target site, the extra target can be substituted for the photo control target. If the extra target is more than 900 ft. left or right of the flight path, both the extra target and the photo control target should be set.

4-4.02 **NON-TARGET CONTROL**

There will be occasions when non-targeted photography must be used for photogrammetric mapping. A non-target control point pattern will usually require from 40 to 60 percent more control points than a targeted mapping project. Problems can be expected from:

- a. Difficult to describe control points.
- b. Difficult to measure control points.
- c. Misidentification of control points.

About 10 percent of selected non-target control points can be expected to fail due to one or a combination of the listed problems.

If the failure of a control point or points will cause the analytical solution to attempt to span or bridge more than the allowable number of models, the photo control project will have to be returned to the field for further survey work on additional control points.

If control point failure can be anticipated by recognizing some or all of the listed problem conditions, extra “buddy” or “insurance” points can be selected before the project is sent to the District for field survey work.

The problems associated with the use of power poles as horizontal control points are:

- a. Power poles are often replaced with new poles by setting the new pole immediately next to the old pole, transferring the wires, and removing the old pole. If the old pole is on the photography and the new pole is surveyed, there will be an error will in the coordinate positioning of the pole.
- b. Power poles are often set on sloping ground and the reference point of pole, pole shadow, and ground surface will change as the camera angle changes.
- c. Power poles are often found to have the center of the base of the pole, obscured by tall grass, weeds or other objects.
- d. Power poles are often found to be standing in a “non-perpendicular to the ground” position and the base of the pole, pole shadow and ground surface will change as the camera angle changes.
- e. Power poles that occur towards the center of a photograph often have the pole base obscured by the top of the pole cross-arms, or power transformers.

Poles and posts of 10 inches or less diameter tend to become indistinct as the quality of the photography degrades and contrast problems occur. Poles and posts of 20 inches or more diameters become very difficult to measure with the necessary precision and repeatability.

There are extensive areas in rural Minnesota where utilities have been placed underground and very few utility poles will be found. Trees can be used as horizontal control points but they are subject to many of the same problems that poles have in addition to a few more:

- a. Few trees have a uniform shape to the tree trunk at the base.
- b. Tree trunks seldom grow perpendicular to the ground.
- c. Trees that occur towards the center of the photograph will usually have the tree base obscured by overhanging branches.
- d. Trees that were photographed on a windy day may have an image shift from one photograph to the next photograph, making stereoscopic positioning difficult or impossible.

When good photography is being used and good horizontal control points are available, a minimum non-target control pattern can be used. The best control pattern will meet certain guidelines.

4-4.0201 Non-Target Control: Horizontal Only

A photogrammetric mapping request for “planimetric mapping only” will require horizontal (x-y) coordinates for the control points. The average vertical datum to be

assigned for aerotriangulation purposes will be determined from whatever source is available, usually a USGS quadrangle map showing 10-foot contour interval elevations. Adjustment during the triangulation process will correct control point elevations to within plus or minus 5 ft.

A horizontal control point must allow the precise determination of the horizontal (x-y) coordinates of the control point from at least two and sometimes as many as six different camera angles. The best horizontal control point would be a clearly visible mark on a flat surface with an unobstructed viewing cone of 45 degrees skyward in all directions. The best horizontal control point does not often occur on photogrammetric mapping projects. Horizontal control points are points that can be clearly seen and measured precisely both in the field and on the photography. Man holes, catch basins, intersections of painted striping and right angle corners of paved or concrete surfaces make good horizontal control points.. Poles will only be used if nothing else is available.

4-4.0202 Non-Target Control: Horizontal and Vertical

A photogrammetric mapping request may ask for some form of ground elevation measurements from jobs previously flown and not targeted. The usual format for ground elevation measurements will be a DTM - digital terrain model.

Vertical control points must be located on or outside of the intended mapping limits. If the mapping limits are unknown or the possibility of mapping extensions exist, vertical control points will be located 750 ft plus or minus 150 ft left and right of the center of the flight strip.

When good photography is being used and good vertical control points are available, a minimum non-target control point pattern can be used. The most likely control pattern will conform to the same criteria for horizontal control given above for non-targeted photography plus the following criteria given for non-targeted vertical control.

A vertical control point pattern should conform to the following minimum/maximum restrictions:

- a. Each photographic strip will have six vertical control points in the first and last model of the strip.
- b. No more than seven models will occur along a mapping strip between the six point vertical control models. The six point vertical control models should coincide with the 4 point horizontal control models when horizontal control is also required.
- c. No more than one model will occur between vertical control points along the strip.
- d. No more than two models will occur between vertical control wing points in the upper one-third (left wing points) of the models along the strip and no more than two models will occur between vertical control wing points in the lower one-third (left wing points)
- e. No more than 2 models will occur between models having a vertical control point in the upper and lower one-third (left and right wing points) of the same model.
- f. A vertical control point will be selected in the middle one-third of each model that has vertical control points in the upper and lower one-third (left and right) wing point positions.

Conditions can occur in photogrammetric mapping projects that suggest more than usual control problems can be expected. Some of those conditions are:

- a. Good vertical control points are not available in the mapping area. This condition often occurs in rural areas with extensive cultivated cropland.
- b. Unusually rough terrain is to be mapped and abrupt scale changes can be expected. The Mississippi River Valley in southeastern Minnesota and Lake Superior's North Shore are examples.

When any or all of the listed conditions exist (obvious or suspected), extra "buddy" or "insurance" control points will be selected.

4-4.0203 Possible Problematic Control

Conditions can occur in planimetric mapping projects that suggest control problems may be expected. Some of these conditions are:

- a. The quality of the photography is less than standard. This often happens with fall photography. Poor contrast, low sun angle, and long dark shadows are usually present.
- b. Photographic scale is distorted by tip, tilt and/or crab of the aircraft.
- c. Good horizontal control points are not available in the mapping area.
- d. If unusually rough terrain is to be mapped radical scale changes can be expected.

When any or all of the above conditions exist (obvious or suspected), extra "buddy" or "insurance" control points will be selected.

4-4.03 PROJECT PLANNING - POST FLIGHT SETUP

Photogrammetric post flight project planning begins with a mapping request submitted to the Photogrammetric Unit. All mapping requests should be processed through the District Surveys Office.

Mapping requests need to be submitted on a Request for Photogrammetric Mapping Form (Figure 4-4.03). Along with the mapping request form, mapping limits need to be placed on the photo index sheet(s) outlining both the planimetric limits and the vertical limits (if applicable).

The entire Project Planning Package should contain the following items to process the request:

- a. Request for Photogrammetric Mapping Form
- b. Photo Index with mapping limits
- c. Contact prints of the entire project with target locations identified.
- d. Target tie sheet
- e. Target Pattern Layout w/district target number assignments

Upon receipt of the Project Planning Package, the following procedure is used to set up a photogrammetric mapping project.

- a. Using the Photo Index negative or digital file, available from the Photogrammetric Unit, two photo indexes will be ordered from the Mn/DOT Photo Lab, or plotted.
- b. Mapping limits supplied by the client will be transferred to each of the Photo Index prints. One print is to be retained in the Photogrammetric Unit's correspondence file, and the other will be sent to the district for use and inclusion in the Photo Control Project Book.
- c. Determine the first and last mapping model needed for each strip of photography. If adequate control points (target or photo image) will be available at or outside of the mapping limits, the first and last photo used for mapping each strip can be listed on the photo index.
- d. A film diapositive or digital image of each photograph to be used in the aerial triangulation solution will be ordered or scanned from the film negative. Photo mapping information such as mapping limits and control point locations can be placed directly on the diapositives if used.

If proper control does not appear or exist in the first and last mapping model, additional photo exposures may need to be added if they exist until acceptable control points can be located. Each strip must be independently controlled. When the first and last exposure of each mapping strip has been selected, a photo order will be submitted to a contracted consultant or our in-house Photo Lab so that replacement photos are produced for the districts files.

4-4.0301 Photograph Marking

Control photos will be marked with specific information on particular photos. Do not mark photos with permanent felt tip markers. Mark photos with erasable ink pens.

The following data will be marked on control photos:

- a. Plan Mapping Limits: mark mapping limits on even numbered photos. Use the vertical center of the odd numbered photos to create the match line between the even numbered photos.
- b. Horizontal control points: mark horizontal control points on the even numbered photos only.
- c. Vertical control points: mark vertical control points on the odd numbered photos only.
- d. Total control points: mark total control points on both the odd and the even numbered photos.
- e. Triangulation Vertical Control: mark triangulated vertical control points on both odd and even numbered photos.
- f. Pass Points (office processing): pass points will be marked on both odd and even photos if a manual or semi-automatic aerotriangulation (A.T.) process is going to be used.
- h. Tie Points (office processing): tie points will be marked on all photos if a manual aero-triangulation (A.T), or semi-automatic aerotriangulation process is going to be used. If a fully automatic aerotriangulation software is being employed the software will automatically select the passpoint locations and numbering scheme, and they will not be marked on the photos.

4-4.0302 *Control Point Diagram*

A control point diagram will be required for each photo control project. One copy of the control point diagram will be retained in the Photogrammetric Unit correspondence file and one copy will be for field survey use and inclusion in the Photo Control Project Book.

The following procedure will be the normal sequence of steps in creating a control point diagram:

- a. Two additional copies of the photo index for project will be produced from the negative or digital file that is stored in the Photogrammetric Unit.
- b. The photo control points (targets or image points) will be marked on each copy of the photo index. Each control point will be marked using the proper photo control symbol and photo control number.
- c. A north arrow will be placed on each sheet of the photo index. If a flight photo index has flight strips that are broken and rotated in order to fit the entire project on a sheet or to reduce the number of sheets multiple north arrows may be added to show the orientation of the flight strip.
- d. Place a photo index legend (Figure 4-4.0302) following the standard A.T. format on each sheet of the photo control index if multiple sheets exist.

4-4.0303 *Control Point and Passpoint Numbering*

All photogrammetric photo control points must be assigned a unique point number. Duplicate point numbers must be avoided.

All ground based targets placed prior to the photography being taken will be numbered starting with 601 and advance sequentially. If it's determined additional image points are needed after the flight has occurred they will be selected and given a numbering sequence starting with either 700, or 800, series depending on number of targeted control points on the project..

If a manual aerotriangulation process is used on the project, the passpoint numbering system will start with the exposures number followed by a: 01 (for a location near the lower portion of the photo exposure), a 02 (for a location at near the central portion of the photo exposure), or a 03 (for a location near the upper portion of the photo exposure). The exposure number must be at least two characters in length. Exposures 1-9 will be labeled 01-09. If a fully automatic aerotriangulation software is being employed the software will automatically select the passpoint locations and numbering scheme.

4-4.0304 *Control Point Symbols*

All photogrammetric photo control points must be depicted by using the proper control point symbol. The control point symbol will indicate the type of control (horizontal, vertical, total, passpoint, point or triangulated). Use the chart in Figure 4-4.0304 to select the correct control point symbol. All types of control points are to be labeled on the contact prints except for the passpoints and tie points if a fully automatic aerotriangulation software is to be used. Only the horizontal, vertical, total, and triangulated control points need to be marked on the photo index control point diagram.

4-4.0305 Control Point Tabulation Sheets

If it is determined that any additional image points are needed for control after the flight has occurred they will be marked on the photos, included on the control point diagram (photo index) and listed on Control Point Tabulation Sheets (Figure 4-4.0305). The Control Point Tabulation Sheet(s) will be sent to the district Surveys office for them to obtain the coordinates of the additional control points.

4-4.0306 Control Point Survey Data

The following data will be assembled and placed in a Photo Control folder to be sent to the district surveys for the photo control survey:

- a. Photo copy of Mapping Request
- b. Control Point Diagram (Photo Index)
- c. Control Point Tabulation Sheets
- d. Annotated contact prints (Control Photos)

A duplicate of all photo control survey data is to be retained in the Photogrammetric Project correspondence file. Analytical Triangulation office processing will commence when the field survey has been completed and the photo control folder is returned to the Photogrammetric Unit.

4-5 AEROTRIANGULATION

4-5.01 INTRODUCTION

Aerotriangulation (A.T.) is the term most frequently applied to the process of using known ground point locations for determining X, Y and Z ground coordinates of other individual points, and the camera locations and position (pitch, yaw and roll) at the time of the photo exposure. This information is then used as control to set up individual stereo models so mapping can be done from them. The aerotriangulation process is often times used over field surveying because of cost, dangerous field conditions such as freeways, steep slopes, etc, and it provides a controlled environment eliminating the need to access private property and difficult areas to survey. The aerotriangulation process produces an aerotriangulation solution or sometimes referred to as analytical solution. The terms aerotriangulation and analytical solution are oftentimes used interchangeably. The analytical solution is the tying together of the individual photo exposures and the computation of the equations and solution of them to fit the photographic strip to the known ground survey points (also known as field control). This process is possible because the known ground control points, and known information about the camera geometry used to fly the project, and the mathematical equations developed between them.

This section of the Photogrammetric Chapter is intended to acquaint the reader with Mn/DOT's aerotriangulation procedures and requirements for performing aerotriangulation. Most all projects have aero-triangulation performed on them. Occasionally on very small mapping areas the Photogrammetric Unit may elect to use a full field procedure where a survey crew obtains enough control points to set up a pair(s) of photos without an aerotriangulation solution having to be run. These projects consists of one to three mapping models where the minimum number of control points the field crew needs to obtain would be about equal to the number required to run an aerotriangulation.

As of October 2004 all aerotriangulation done by Mn/DOT has been done using digital images (softcopy methods). Mn/DOT uses manual, semi-analytical, or fully automatic aerotriangulation procedures to provide a means in which to reduce the number of field survey points (either targets or photo identifiable points). The type of procedure, and software used is dependent on the project, product, and sometimes camera that was used in the acquisition of the aerial photography. The software packages the Photogrammetric Unit has available for running aerotriangulation are: *INPHO's* MATCHAT, *BAE's* SOCET SET MST, and *Intergraph's* ISAT software.

All projects that require design type accuracy are targeted as described in section 4-4.01. Projects flown with planning or documentation as the main objective may have a relaxed accuracy requirement. In such cases a project may be flown at a higher altitude utilizing a reduced number of targets and/or flown using airborne GPS-IMU technology. A Global Positioning System (GPS) antenna is mounted on the aircraft and an offset measured to the center of the camera lens. Attached to the camera mount is a Inertia measurement Unit (IMU). The GPS antenna and offset measurement determines the location of the camera at each exposure, and the IMU system determines the angles (also known as attitude, or position) of the camera at each exposure. This information alone will enable a stereomodel to be set up and mapped from, however the with a limited number of ground targets the camera location and position can be to be refined to provide better accuracy.

During the Aero-triangulation procedure the photo control (ground survey) points can be given estimated accuracies. When the programs are run individual photo control points can be weighted based upon their defined accuracies.

4-5.02 MAPPING MODEL

When aerial photography projects are flown a timer on the camera is set to fire it on a time cycle that provides for 55%-65% overlap between successive photos. This overlap area is called a model and is the basis of all aerotriangulation and mapping. A “neat” model is the area of overlap between the vertical centerline of one exposure to the vertical centerline of the adjacent exposure along the strip of photography.

An analytical solution cannot be run across a model that is composed entirely of water. Likewise a stereomodel that consists of all water except for a road or bridge running across the center of the model will not make for a good analytical solution. If any such areas exist, field control must be established on both sides of the water and the strip may be treated as two separate jobs for analytical processing. At times it may be necessary to fly at a higher altitude in order to minimize this occurrence.

4-5.03 AEROTRIANGULATION PROCEDURE

Before the aerotriangulation can begin the district must submit the target or image point coordinates that are being used as the photo control. The photo control file should be a comma delimited text file produced by the district Surveys office. This file contains the point number, X coordinate, Y coordinate and Z coordinate to three decimal places of any targets and/or image points used for photo control. This file should be submitted with _tgt.txt as the extension.

Because of the various software programs the Photogrammetric Unit has available and the options in regard to the amount of interaction required, the following text on procedure will be a summary and be general in nature.

The Aerotriangulation steps are:

- a. Importation of data. Into a Project Management directory, import camera calibration information, control point coordinates, and approximate camera/flight strip location. Approximate camera/flight strip data can be obtained from the flight navigation data, a quad map, or from a dump of the flight strip information that was entered into Mn/DOT's Photogrammetric database.
- b. Interior orientation. The exposure or image is orientated to tie it to the camera by reading/measuring the fiducials. This ties the imagery to the camera geometry. This step can be done either manually by the operator, semi-automatically by the operator and software, or fully automatically by the software alone.
- c. Relative orientation. The exposures or images are orientated to each other by generating/measuring points that fall in the overlap areas between the proceeding and succeeding photos. This can be done either manually by the operator, semi-automatically by the operator and software, or automatically by the software alone. This can be done either monoscopically or stereoscopically. A minimum of nine points per image are selected and read if doing the process manually. If the software does the selection and reading of the points automatically many more points may be generated for the relative orientation.
- d. Control point measurement. Targets and image points are read/measured. This can be done either manually by the operator, semi-automatically by the operator and software, or automatically by the software alone. This step can be done either monoscopically or stereoscopically.

- e. Strip formation. This step ties all the individual exposures together in a strip formulated in model space.
- f. Strip Adjustment and coordinate transformation. The strip, in model space is fitted to the control in the ground space coordinate system. This involves a polynomial strip adjustment, and a three dimensional rigid body coordinate transformation.
- g. Photo Resection. A space resection is performed to compute the X and Y location, the elevation, and the angles (roll, pitch and yaw) of the camera during the moment the exposure was taken.
- h. Space intersection. Computes X, Y, Z ground coordinates for measured points (non-control points or passpoints) that do not have a corresponding survey coordinate.
- i. Block or Bundle adjustment. Ties all flight strips together and performs a non-linear least squares adjustment to best fit all of the control.
- j. Refinement of camera location and angles, and ground coordinates of measured points based on results of bundle adjustment.

During relative orientation (item c above) the points selected are often referred to as passpoints. The relative orientation points and passpoints can be one in the same or they can be separate points. The control point measurement phase (item d above) may also be done at the same time as the relative orientation phase depending on the software being used. When one strip of photography meets the beginning of another strip or runs parallel to an adjacent strip the relative orientation points that fall in the overlap area are referred to as tie points. These points serve to tie the strips together and process the job as a whole.

If selecting the passpoints manually the ideal location of the passpoints would be at the vertical center of the photo approximately one inch from the top and the bottom edge of the imagery, and one at the center along the neat model line. (Figure 4-5.04). A passpoint any closer to the edge may cause problems due to lens and image distortion that may occur near the edges of the photo. Water, trees, swamps, rock ledges, other features, or a lack of contrast that may not lend to good stereo viewing may not allow the placement of the passpoint point in the ideal location. Another consideration for passpoint location is the layout of the photo control or targets. The aerotriangulation programs will compute the coordinates of the passpoints points based on the known ground control. The passpoints should therefore be located within the control network not outside of it. If the passpoint is located outside of the photo control the computed coordinates will be based on an extrapolation. For this reason it is important that targets used for photo control be placed such that they encompass the passpoints.

When reading/measuring the passpoints the measurements are stored as photo coordinates. The photo coordinates are derived from the information of the fiducials coordinates, principle point of symmetry and amount of lens distortion listed in the camera calibration report. With this information the software programs used with the scanner and/or aerotriangulation software can compensate for camera film shrinkage or expansion. Most aerotriangulation softwares can also correct for earth curvature and atmospheric refraction but at the flight height and length of Mn/DOT projects this is negligible. During strip adjustment and coordinate transformation (step f above) the photo coordinates are converted to ground coordinates. This is possible due to the known geometry of the camera, and the photo control points (ground targets and or image points) known coordinates in both the ground based coordinate system and the photo based coordinate system.

Sometimes ground targets are lost prior to the flight taking place especially in agricultural areas. In such cases an acceptable image point can't be located to be used as control. In such cases the Survey crew may obtain a triangulated point. A triangulated point is a control point the survey crew provides that has a X, Y, coordinate with an elevation attached to it. A triangulated point is used as vertical control only because the only way to determine on the photo image where this point was obtained is to drive or navigate to it's X,Y location. There is no distinct feature on the photo image to tell where the control point was obtained and if used as horizontal control it would only throw error into the strips horizontal solution. If triangulated points are required a preliminary aerotriangulation must be run in order to provide a solid horizontal solution in order to provide a means to navigate to the X,Y coordinates that determines where the elevation to be used as vertical control was obtained. This location is then added or appended to the original control point measurements and the adjustment programs are re-run.

4-5.04 AEROTRIANGULATION ACCURACIES

The end result of the aerotriangulation programs is a listing of the misclosures of all the surveyed control compared to the adjusted values after the best fit to the control and the photo resection. Typically the detailed design mapping project misclosures will be less than 0.15 feet horizontally and vertically with a maximum allowable of 0.35 ft horizontally and 0.25 ft. vertically . If the best-fit solution indicates errors greater than 0.50 ft horizontally and 0.25 ft. vertically the field surveyed control points will be examined and their weighted values may be adjusted to try and determine which control point(s) are causing the aerotriangulation misclosures to exceed tolerances . If it is deemed critical to the integrity of the analytical solution the relative orientation and control point measurements will be checked. If center point data is available selected stereomodels will be set up to see how the stereomodel setup matches the center point data. If the stereomodel setup appears to be in disagreement with the center point data and the relative orientation measurements are within their normal tolerances, additional field survey work will be requested before the project gets passed on for map compilation. If the point is not crucial to the formation of the analytical solution and there is adequate photo control without the point, it will be omitted. Mn/DOT accuracy standards for aerotriangulation call for the RMSE values in X,Y and Z not to exceed 1/10,000 of the flight height if survey quality control is obtained and the flight is going to be used for mapping purposes.

4-5.05 AEROTRIANGULATION OUTPUT

In addition to the control point misclosures the aerotriangulation software generates several files that can be used for the setting up of stereo models on the digital workstations. Depending on the aerotriangulation software used files may be generated that contain: the interior and relative orientation measurements, the control – either surveyed or adjusted, the refined passpoint coordinates, a model coordinate file, a camera calibration parameter files, and a camera station file. The camera station file contains the results of the resected photos with the X,Y, and Z coordinate and the angles (roll, pitch and yaw) of the camera at the time the image was exposed, and is the main file needed for stereomodel setup. If this information is embedded in one of the other files it will need to be stripped out and written to a text file containing only this information. (Figure 4-5.05) The camera angles for roll, pitch and yaw are listed in either decimal of degrees, radians, or gradains (gons) depending on the software.

4-5.06 AEROTRIANGULATION REPORT

After generating the analytical solution, the technician will withhold at least one photo control point per strip and re-run the aerotriangulation programs. The withheld control point will be assigned computed coordinates derived from the analytical solution. The computed coordinates are compared to the field surveyed coordinates as a check. If the difference between the computed coordinates and the field values are greater than those listed in Section 4-5.04, the same procedures will be followed. The technician who generated the analytical solution will create a report. The

report will describe the project, and any unusual conditions that were encountered. It will list the misclosures of the test points and the average X, Y, Z residuals from the solution, any targets or control points not used as control, what camera was used in creating the aerotriangulation solution, and any other information relative to creating the aerotriangulation solution

A copy of the report is stored on the server with the output files from the aerotriangulation, and a copy is kept in the projects correspondence file. A copy of the report is will be sent to the District Surveys Office if any unusual circumstances were encountered.

4-5.07 PROJECT RECORD SHEET

A Project Record Sheet is created when the aerotriangulation is finished. The project record sheet is made from a program run in the photogrammetric database. It lists the models that need to be compiled along with information needed by the photogrammetric technicians and editors. The project record sheet also helps keep track of the jobs progress, or a screen in the Photogrammetric Database can be edited to keep track of the projects progress.

4-6 DIGITAL MAP COMPILATION

4-6.01 INTRODUCTION

This section outlines hardware, software, digital map compilation requirements and procedures used to produce photogrammetric mapping. At the time of this publishing *BENTLEY's* MicroStation Version 8 is the CADD Standard used for all mapping projects. See Mn/DOT's CADD Standards documentation on the Web at <http://www.dot.state.mn.us/tecsup/caes/> for the most current standards, libraries, resource files, and settings.

4-6.02 STEREOPLOTTERS/DIGITAL WORKSTATIONS

As of Oct. 2005 all of Mn/DOT's internal photogrammetric map compilation has been done utilizing digital workstations and digital images. No longer is Mn/DOT's internal staff compiling from diapositives with stereoplotters, although some of the contractors Mn/DOT outsources work to may be using diapositives and stereoplotters in lieu of digital images and digital workstations. The Photogrammetric Unit currently operates two shifts because of workloads and to fully utilize costly equipment and software.

4-6.03 MAPPING HARDWARE AND DATA COLLECTION SOFTWARE

Mn/DOT's digital workstations used for mapping utilize the *DATUM's* Summit Photogrammetric Suite, and *Intergraph's* Image Station software. Map compilation is done directly into Bentley MicroStation. For producing mosaics software from *BAE's* Socet Set and *Intergraph's* Image Station software is used.

4-6.04 MAPPING SCALES

Mn/DOT's graphic mapping files are compiled at the following scales depending upon what units are requested. Typically urban areas are compiled at 1" = 50' and rural areas are compiled at 1" = 100'.

4-6.05 TYPES OF MAPPING

The type of mapping that will be produced and delivered will be one of or a combination of the following.

4-6.0501 *Planimetric*

Planimetric mapping is the mapping of the features only and not the terrain. Only features that can be seen on the aerial photography and identified will be digitized. Depending upon the scale of the mapping, all features that are visible and identifiable will be digitized. Any underground utilities or possibly other features such as culverts where both ends are not visible will need to be surveyed and added to the map by District Surveys office. When the planimetric map is to be compiled at 1"=100', the depiction of some of the features only causes clutter and as such will not be digitized (i.e. some sidewalks around houses, shrubs, patios, small retaining walls). The planimetric map will be delivered as a 2D file therefore, no vertical information can be obtained from it.

Planimetric map features that will be digitized include:

Airports & Runways	Field Roads	Piles (coal,sand,etc.)	Signs (large)
Athletic Fields	Fire Hydrants	Platforms & Ramps	Stacks-Chimneys
Billboards	Fuel Pumps	Playgrounds	Swamps
Buildings	Green Houses	Pools (inground)	Tanks
Borrow Pits	Guardrails & Posts	Quarries	Tennis Courts
Bridge Curbs	Hedges	Radio Towers	Traffic Lights
Catchbasins	Lamp Posts (private)	Railroads	Trails
Cemeteries	Light Posts	Retaining Walls	Transmission Towers
Conveyors	Manholes	Rivers & Streams	Trees (except very sm.)
Culverts	Monuments (Hist'cal)	Roads	Tunnels
Dams	Nurseries (plantings)	Ruins	Utility Poles
Ditches	Parking Areas	Shoulders-roads	Walls
Driveways	Patios	Shrubs	Water Towers
Fences	Piers	Sidewalks	Wooded Areas

4-6.0502 *Digital Terrain Model (DTM)*

The DTM consists of vertical elevation data in the form of breaklines and spot shots (mass data points). Breaklines (data strings) are compiled along the breaks or changes of grade in the terrain, and spot shots are added in areas where the terrain is relatively flat or uniformly sloping. The DTM data will be of sufficient density to correctly portray the ground. If the ground is obstructed from the aerial view by bridges, trees, high grass or other features to the extent it can not be accurately portrayed a void, or hole will be left in the data. If this missing information is important to the project the District Surveys office will need to field survey the area and supplement the photogrammetric DTM. The DTM data is used to produce a wire frame or triangulated irregular network (TIN) between each data point and its adjacent data points or line strings (breaklines). From the TIN file, contours or cross-sections can be generated based on an interpolation of the TIN data.

4-6.0503 *Contours*

A contour line is a line representing the same elevation along the terrain. Spot elevations are points with a labeled elevation placed where changes in slope occur between the contours. A contour map will consist of both contours and spot elevations. Contours will generate more data making larger files than a DTM and will not allow the user to cut cross-sections. Contours as well as cross-sections can be generated from the DTM therefore all projects will be mapped as a DTM unless contours are specifically requested or there is sufficient reason to do so. Contours generated from a DTM will not automatically contain spot elevations. For special situations where it may be beneficial to have contour mapping instead of the contours generated from the DTM the Photogrammetric Unit can produce a contour map.

4-6.06 **STANDARD AND REDUCED DETAIL**

On projects where planimetric mapping extends beyond the vertical mapping limits, it is recommended that a standard and reduced detailed mapping scheme be used. Using this method will reduce the turnaround time to produce the photogrammetric base map.

4-6.0601 Standard Planimetric Detail

Standard detail mapping would include all digitized features list in Section 4-6.0501 above.

4-6.0602 Reduced Planimetric Detail

Reduced detail mapping would include only the following features:

Roads	Hydraulic features	Sidewalks (only on Blvd.)
Buildings	Major tree groups	Towers
Driveways	Parking lots	

4-6.07 FILE TYPES

All graphic and binary files compiled and produced from the aerial photography will be done in a 3D file. All DTM data will be delivered in 3D files. All contour and planimetric data although compiled in 3D are converted to 2D data for editing purposes and then delivered in a 2D format.

4-6.08 DATUMS, COORDINATE SYSTEMS

The photogrammetric mapping will be compiled using the datum and projection that was used to establish the photo control. The coordinate system used will be Mn/DOT's County Coordinate System. If a project crosses over into another county the mapping will generally be broken at the county line. The photo control submitted by the district must be in the same units, datum, projection, and adjustment that the mapping is to be delivered in.

4-6.09 MAPPING DESIGN FILE PARAMETERS

For the purpose of setting parameters a seed file is created. All files made thereafter are made by copying the seed file. The global origin used for all digital map files will be X=0, Y=0 and Z=0 for 3D files and X=0, Y=0 for 2D files.

The design file working units will be set as follows unless specifically directed otherwise:

English -Unit Names
Master Units: Feet
Sub Units: Feet
Resolution: 1000 per foot

Current CADD standards will be adhered to.

4-6.10 REQUIRED FILES

Before the digital map compilation can begin the Photogrammetric technician will need the following files:

4-6.1001 *Planimetric Projects*

- a. Photo control or ground control file. A comma delimited text file produced by the district Surveys office. This file contains the point number, X coordinate, Y coordinate and Z coordinate to three decimal places of any targets and/or image points used for photo control. The file should be submitted with _tgt.txt as the extension. This would be the same file submitted for the aerotriangulation.

If aerotriangulation was run for the project the output files produced by the aerotriangulation will be used for setting up the stereomodel. If the project is small and no aerotriangulation was performed the ground control file is required. The ground control file would be in the same format as the file submitted as the photo control file needed prior to the start of aerotriangulation. The ground control file would contain the point number, and X, Y, Z, coordinates of the image points that are to be used as control in lieu of the targets.

4-6.1002 *DTM Projects*

In addition to the file(s) listed above for in section 4-6.1001 DTM projects require the additional files listed below:

- a. Centerpoint comma delimit text file produced by district Surveys. This file shall include the point number, X coordinate, Y coordinate, and Z coordinate. The file should be submitted with a _cpt.txt extension.
- b. A GEOPAK GPK file containing the Photo control targets coded as TGT, the Centerpoint shots coded as CPRO and the random test shots used for map accuracy checking coded as TPRO.
- c. Multi-Shot reports of the targets and random test shots, supplied by district surveys.

All coordinate values and stationing should be entered in to three decimal places.

4-6.11 STEREOMODEL SETUP PROCEDURES

The area to be mapped will consist of any number of stereomodels, the stereomodel being the overlap of two consecutive photographs. Each stereomodel must be set up individually on the digital workstation. Once the stereomodel is setup and orientated correctly map compilation can begin. The following steps describe the setup and orientation procedure. Some of them may be omitted dependent on if an aerotriangulation was done, the aerotriangulation software used, and what data can be imported from it.

Once the digital images of the photographs are loaded onto the workstation they may be compressed and overviews may be created. They may be re-formatted to a format more efficient to the operation of mapping software.

The steps required for steromodel setup are to create a new project using the project management software, and import the aerotriangulation data, the camera calibration data, and/or the surveyed ground control, Once this is done an inner orientation, and then an exterior orientation are performed.

4-6.1101 *Inner Orientation*

The interior orientation consists of creating or importing a camera calibration file that contains the camera focal length (CFL), location of the principal point and the calibrated lens distortion and then reading (measuring) the fiducial marks on the corners and sides of the digital images. The reading of the fiducial marks can be done either manually, semi-automatically or automatically.

4-6.1102 **Exterior Orientation**

A relative orientation combined with an absolute orientation is known as the exterior orientation.

- a. Relative orientation is determining the positioning and angular attitude of one photograph in relation to the other photograph of the stereomodel. This is accomplished by clearing out parallax in specific areas of the stereomodel.
- b. Absolute orientation is the scaling, leveling and orienting of the photo images to fit the surveyed ground control and the analytically derived control points (passpoints). The absolute orientation can also be done by importing the camera station (location) along with the camera angles (roll, pitch and yaw) at the time the exposure was taken. This information can be obtained from the aerotriangulation process if it was performed. The images are then adjusted automatically by the photogrammetric software to fit the control, or the photo images perspective is adjusted based on the cameras location and angles.

Before the absolute orientation can be performed either the control point information (coordinates) or the camera station (location) and camera's angular positions at time of exposures which is generated from the aerotriangulation process needs to be available.

After the absolute orientation is performed the stereo model should be parallax free and can be viewed in three dimensions. Horizontal and vertical measurements can then be made from the photos.

4-6.12 **PLANIMETRIC STEREOMODEL SETUP**

The stereomodel is determined to be set up properly if the photo control and/or passpoint best-fit solution is less than 0.5 ft horizontally and 3 ft vertically.

4-6.13 **DTM STEREOMODEL SETUP**

The stereomodel is determined to be setup properly if the photo control and/or passpoint best-fit solution is less than 0.5 ft horizontally and 0.3 ft vertically.

If it is determined that the stereomodel cannot be set up properly, the project will be returned to the Analytical Unit. If the Analytical Unit fails to resolve the stereomodel setup problem, additional field survey work will be requested.

4-6.14 PLANIMETRIC FEATURE COMPILATION

The photogrammetric technician creates a MicroStation design file by copying the 3D seed file, and calls up two overlapping photo images and the mapping interface software. The mapping scale is set and the operator proceeds to digitize the mapping limits. The technician proceeds to map all features listed in Section 4-6.0501 that fall within the mapping limits on the overlap area of the two images. A Polytel keyport attached to the PC and interfaced to the digital workstation contains macro commands necessary to digitize the various features.

The macro command is a batch program that sets the proper attributes and command to place the features. A listing of each feature and its attributes can be found in the CADD Data Standards website produced by the Office of Technical Support's CAES – Computer Aided Engineering Services Unit. The web address is <http://www.dot.state.mn.us/tectsup/caes/>

The technician or operator calls up the appropriate macro command moves the on screen cursor or measuring mark onto the feature to be digitized and clicks the data point. The operator does the same along the edge of the roadways, corners of the buildings, boundaries of tree groups, etc.

As each feature is digitized into the design file it is also superimposed upon the image. When compiling the features, the operator does all the same features throughout the stereomodel or compiles the stereomodel area by area such as one square city block at a time.

When the stereomodel is finished, the technician has another technician look it over for completeness and correct representation of the features before it is closed out. The next overlapping image is called up, a new MicroStation design file is created, and the process starts over until all the stereo models that contain mapping have been digitized.

4-6.15 DTM MAP COMPILATION

4-6.1501 Centerpoint Data

On DTM mapping projects after it is determined the stereomodel is setup properly, the center point data graphics file is called up as a reference file and superimposed on the stereomodel. The center point data is used to check the standard photo control and to optimize the vertical accuracy of the DTM. The center point data will be read and used as an index adjustment if necessary. The index adjustment may be needed due to deformation that can occur in the analytical solution or a weak control point. Factors such as water, swamps, dense vegetation and other inaccessible areas do not always allow for optimal target and passpoint placement resulting in deformation to the analytical computations. It is possible that the deformation that can occur may not be apparent in the residuals of the analytical solution. The vertical solution of the aerotriangulation is a best fit of all the field surveyed photo control points used. This may occasionally degrade the accuracy of the individual control points. The centerline profile allows the photogrammetric technician to locally reference the stereomodel to vertical control specific to the area of the model where the DTM is to be compiled. In an effort to determine if deformation exists and to more closely align the computed photogrammetric elevations to true ground, the district surveys office is requested to obtain center point data on all DTM projects.

The center point data consists of a series of shots (X, Y, Z coordinates) taken at or as close to the proposed center line as may be practical and still ensure the safety of the Surveys personnel. The center point data should parallel the proposed centerline and the shots should be taken at an approximated 200 ft interval running the length of the mapping project (Figure 4-6.1501). On projects with parallel flights of photography, the

center point data should be taken as near the center of the photographic strip as possible. The shot interval should remain the same, an approximated 200 ft interval.

Upon completion of the model setup to the analytical solution on the digital workstation, the technician reads and records the center point data. The vertical index on the stereomodel can be adjusted as necessary to achieve a best-fit correlation to the surveyed ground elevations before the model is compiled. If the index adjustment is greater than 0.35 ft, the model will not be compiled and the analytical solution will be checked and possibly re-run. If this fails to lessen the adjustment necessary, additional field survey work may be requested.

4-6.1502 DTM Feature Compilation

The photogrammetric technician creates a MicroStation design file by copying the 3D seed file, and calls up two overlapping photo images and the mapping interface software. The mapping scale is set and the technician will index to the center point data and begin to compile the vertical data into the graphics file. The DTM data is compiled into a separate file than the planimetric data. The operator compiles 3D breaklines of the ground terrain along the following features (Figure 4-6.1502A and Figure 4-6.1502B)

Roadway centerlines	Toe of ditch slopes
Inner edge of shoulders	Top of slopes
Outer edge of shoulders	Ditch bottoms (three breaklines to show rounding)
Curb gutterlines	Any breaks or changes in the terrain
Top of curbs	

Breaklines are linestrings with an elevation attached at the various data points along the linestring. The distance between data points on the linestring will not exceed 25 ft. Spot shots, which are individual points with an attached elevation, are inserted into areas not covered by the breaklines. Spot shots would occur at the natural highs and lows of the terrain and relatively flat or uniform areas, or between breaklines to show radical ground undulations. Spot shots are usually set in a grid pattern and not spaced more than 25 ft apart.

Any area where the ground is obscured and can't be seen or accurately read to within 0.5 ft it will be surrounded by a obscure breakline to denote a void area. Vertical data will not be compiled in the void area. Any vertical data needed in the void area will have to be obtained by the District Surveys Office.

All digitized DTM data is superimposed upon the 3D image. The operator will be able to determine if the compiled areas are sufficiently covered. As a final check of the stereo model contours are generated from the DTM data and superimposed upon the 3D stereo model. Another technician will look it over for completeness and correct representation of the ground before it is closed out. The next overlapping image is called up, a new MicroStation design file is created, and the technician will attach the previously compiled model as a reference file to see how it hits along the edge of the new overlapping photo (model). If the match from the previously compiled model is good the technician will snap to the end of the linestrings and continue on with the linestrings into the new model. This process will continue until all the stereo models that contain mapping have been digitized.

4-7 DIGITAL MAP EDITING

4-7.01 INTRODUCTION

Each stereomodel is compiled individually on the digital workstation. The map editor is responsible for merging all the individual stereomodels together into files of manageable size and area. When the individual models are merged together the editor will make sure all features match from model to model, that all CADD standards have been adhered to, and that all feature collection looks correct. The editor is also responsible for making sure the compiled DTM data will run through the GEOPAK software and create a TIN file. The editor will run the map accuracy tests and deliver the planimetric and TIN files to the District Surveys server after the job is reviewed and approved by the Photogrammetric Engineer or Surveyor..

4-7.02 FILE TYPES

All planimetric files are compiled in 3D but converted to 2D by the editor. By converting the files into 2D format line style rotation caused by 3D linestrings is eliminated. Editing is much easier in a 2D file, and by converting to 2D the user will not be confused as to the vertical accuracy of the map.

All DTM data is compiled in a 3D file, and the binary TIN file delivered to the Districts is a 3D file.

4-7.03 FILE SIZES

All planimetric files delivered will be under 30 MB. The size of the file, not the area, will be the determining factor. If the planimetric data for a project exceeds 30MB additional files will be created. All DTM data will be delivered in one binary TIN file unless the file size exceeds 100 MB. In such cases additional files will be created.

4-7.04 FILE NAMING CONVENTION

All photogrammetric files will start with the letters PH for Photogrammetric followed by, the S.P. number as defined in the Photogrammetric database followed by and extension listed below. The extension will indicate what type of mapping was produced:

- a. 01Pln.dgn would be planimetric only
- b. 01.TIN would be the binary TIN file produced from the raw DTM data
- c. 01dtm.dgn would be the DTM or raw ground data produced from the stereo model.

If a project is large enough to exceed the file size listed in section 4-7.03 above the project will be broken up into several files. The second file will contain an underscore (_) followed by the number 02, the third will contain an underscore (_) followed by the number 0 03, etc.

4-7.05 PLANIMETRIC FEATURE EDITING

Planimetric editing consists of merging the individual compilation files into a single merged plan file up to 30MB in size and then converting it to a 2D file. The editor also performs the following functions:

- a. Checks for feature and pattern matching between stereomodel compilation files.
- b. Snaps together the end points of line style elements for a clean no gap look between compilation files.
- c. Cleans up any overlapping features. i.e. removing sidewalks, treelines, fences, etc. from buildings or roadways, and moves text to reduce clutter.
- d. Checks the mapping against the aerial photography verifying that the mapping is shown correctly according to Mn/DOT mapping and CADD standards.
- e. Checks the delivery scale, size of the cells and line styles, levels, and weights and attributes of the map features and corrects any errors found.
- f. Adds and labels grid ticks in the merged file.
- g. Creates mapping index (see Section 4-7.07).

4-7.06 GRID TICKS

Grid ticks are the last element placed in the edited design file. The grid tick size is determined by the mappings delivery scale. The cell name is "Tick". The attributes for the cell can be found in the CADD Data Standards manual produced by the Office of Technical Support's CAD/GIS System Support Unit.

The spacing of the grid ticks is depended upon the units of the mapping. For English units the grid ticks are placed every 10 inches. A map scale of 1"=50' would have grid ticks every 500 ft. A map scale of 1"=100' would have grid ticks every 1000 ft.

4-7.07 MAPPING INDEX

The editor will make a mapping index (Figure 4-7.07) that fits on a standard sheet of paper. The mapping index will be on the Map Data level and be put in the first planimetric file (.pln.dgn) of the project. The editor will window area the mapping index and save the settings so the first time this design file is called up by the districts the index will appear on their workstations screen. The mapping index will show the mapping limits of the project. Prominent features such as trunk highways, rivers, major roadways, lakes, cities etc. will be labeled for easier map orientation and a north arrow will be placed. The map index will include the following information about the project:

- SP / photogrammetric tracking number
- Project location
- ASP (Aerial Survey Project) number
- TH number
- Type of mapping
- Photo scale
- Mapping scale
- Mapping completed date
- Archive info and phone # to call
- The mapping file names

A hardcopy of the mapping index will be filed in with the projects correspondence file, and the Completed Mapping Projects Book kept in the Photogrammetric Unit. A hardcopy or PDF file of the mapping index will be sent or e-mailed to the District Surveys Office.

4-7.08 DTM EDITING PROCEDURES

DTM files are 3D compilation files consisting of breaklines, spot shots, boundary breaklines and obscure breaklines, which denote void areas. Void areas are outlined with obscured breaklines. Vertical data is not compiled inside the void area because the ground elevation can't be read accurately.

Editing procedures consist of first merging all of the individual DTM files into one merged file. The plan file is attached as a reference file. The editor performs the following functions:

- a. The DTM file is checked for missing and/or incorrectly placed breaklines along road centerlines, top and bottom of curbs, edge of shoulders and ditch bottoms.
- b. All void areas are checked. Void areas must be a closed element. If it is not a closed element, vertical data will be interpolated across the void area.
- c. Check for crossing breaklines. If crossing breaklines are located they must be fixed or they will cause conflicting vertical data when generating the TIN file.

Once the DTM file is edited the GEOPAK application is loaded. Using the Extract Parameters, pull down dialog box from GEOPAK. The breaklines, spot shots, void areas and boundary breaklines are extracted from the DTM file to create a .DAT file. The .DAT file is the collection of all the x, y and z values of the breaklines and spot shots of the DTM file in binary format. The .DAT file can be created in either ASCII or binary format. The advantage of the binary format is that input data is located much faster when generating the triangle model. Using the Build Triangles, pull down dialog box. The .DAT file is read and the X, Y and Z values are triangulated in a binary file. The file containing the triangulated points is called a .TIN file. The .TIN file can be displayed in a MicroStation file by using the GEOPAK Load Triangles pull down dialog box from GEOPAK. The triangulated .TIN file is the core of the DTM process. All subsequent merged models, lattice models and calculations are all derived from this core triangulated model.

4-8 MAP ACCURACY

4-8.01 INTRODUCTION

All DTM mapping projects that are to be used by final design will be checked for accuracy. Mn/DOT uses design's computed earthwork volumes for payment to the contractors. Design computes the volume of earth needed to be moved and/or obtained based on the difference between the terrain before construction and the final design of the project. Typically another DTM is not produced following construction; therefore it is critical that the DTM used by design is accurate. To help ensure that the volumes used for the project are correct, the DTM data is tested for accuracy.

The planimetric data digitized on the map is not formally tested, however, there are several checks built into the process. The geodetic control used to perform the photo control is 2nd order; the photo control itself must meet 3rd order. The aerotriangulation process, which densifies the ground control, also serves as a check of the ground survey. After the photogrammetric map is produced, it is annotated and utilities are added, thus providing a field check of the horizontal accuracy of the map. Because of the variance in terrain and the different types and varying degrees of ground cover commonly encountered on a mapping project accuracies can vary. Figure 4-8.02A indicates the expected accuracies that can be obtained for a mapping project.

4-8.02 MAP ACCURACY STANDARDS

The Photogrammetric Unit uses the National Standard for Spatial Data Accuracy (NSSDA) as the standard for map accuracy testing and reporting. Reporting of horizontal and vertical accuracy for digitized features and for the DTM will be completed in accordance with the current published version of the National Standard for Spatial Data Accuracy. The NSSDA reports the accuracy of the map within a 95 % confidence level. The reported horizontal accuracy is circular and the vertical accuracy is linear.

The horizontal accuracy of all digitized features shall be compiled to meet a NSSDA standard of 1.0 ft. The horizontal accuracy of the digitized features may be tested either by field survey or photogrammetric methods.

The vertical accuracy of DTMs will be tested by creating a GEOPAK TIN file from the DTM data. Elevations derived from the TIN file will be generated at selected X,Y coordinate locations that are determined by the district survey crews. The generated elevation will be compared to the ground surveyed elevation at the same X,Y coordinate location. The accuracy of the TIN file derived points shall meet a NSSDA standard of 0.5 ft.

The National Standards for Spatial Data Accuracy (NSSDA) reporting standards will be used. The planimetric file will contain an accuracy statement on Map Data level reporting the NSSDA horizontal and vertical accuracy of the project. Projects encompassing more than one file will be tested and reported on a project basis and not individually. The accuracy statements for both the horizontal accuracy and the vertical accuracy will be in the planimetric (pln.dgn) file. The vertical accuracy statement is put in the planimetric file instead of the TIN file because the TIN file that is delivered is in binary format.

4-8.03 MAP TESTING PROCEDURES

The map accuracy test will be a test of the vertical data derived from the TIN file which is created based upon the DTM compiled by the photogrammetric technician.. The test is a direct comparison between elevation of the field surveyed point and the interpolated elevation derived from the TIN model.. The X, Y, Z coordinate, point number and station of the field survey test shots contained in the .GPK file are loaded into the GEOPAK under the GEOPAK Road, Geometry, Coordinate Geometry module. The projects associated GPK file is selected, the Element Point, and

Compare Points to TIN routine computes an elevation from the TIN model at the ground surveyed location. The Compare Points to TIN routine also compares the TIN models computed elevation to the actual surveyed elevation, performs a statistical analysis and computes the NSSDA accuracy of the TIN model. An output file called compare.txt is produced (see Figure 4-8.03).

4-8.04 ACCURACY TESTING ANALYSIS

Upon completion of accuracy testing programs the results are reviewed. Any test that does not meet accuracy standards is investigated. A graphic file of the test shots (TPRO shots) is called up and displayed over the mapping area to give a visual representation of where the test shots were taken. If there are shots that cause the accuracy test to fail, these shots are examined to find the cause of the discrepancy. If the mapping is suspect the model that the test occurs on is reset on the digital workstation. The breaklines and spot shots surrounding the test shots are checked for accuracy and checked for correct representation of the terrain. If an error is found in the breakline or DTM data, it will be recompiled and the remainder of the model will be scrutinized. If the DTM data appears to be of sound integrity, the District Surveys Office will be contacted to see if any type of earthwork, erosion, or construction had taken place between the photography date and the time of the field work. If no such changes have occurred, the District Surveys Office will be requested to check their field work and/or obtain another test in close proximity to the failed test.

4-8.05 MAP ACCURACY REPORT

Upon completion and/or resolution of any map accuracy problem areas, a Map Accuracy Report will be drafted. The report will describe the project, any aerotriangulation and accuracy testing problems encountered, and what course of action was taken to resolve them. The report will list the results of the accuracy tests and detail the accuracy standards adhered to. All pertinent hard copies and correspondence will be included in the report. The report will also include the signature and registration number of the Photogrammetric Surveyor/Engineer or ASPRS Certified Photogrammetrist. The Map Accuracy Report is filed with the contact prints after the project has been delivered. The contact prints and Map Accuracy Report are stored in the Photogrammetric Unit for approximately one year and then sent to the Record Center, which retains the contact prints, and Map Accuracy Report for up to ten years.

The reports synopsis and accuracy output files will be stored in a folder called "Accuracy" in the same location the project is archived. It is also scanned into Mn/DOT's EDMS (Electronic Document Management System) system.

4-9 MAPPING DELIVERY AND ARCHIVING

4-9.01 INTRODUCTION

This section identifies the procedures used to deliver, archive, and retrieve completed mapping projects. After the base map is delivered, the District Surveys Office is responsible for annotating, supplying vertical data to the voided areas, adding utilities, and an overall field check of the map.

4-9.02 MAPPING DELIVERY

The completed digitized photogrammetric map files will be archived in a Public folder on a server assigned to Land Management's Photogrammetric Unit. The files can be copied or downloaded by the districts from this location. The District Surveys Office will be notified of the files location and the mapping index created by the editor showing the area mapped will be sent to the District Surveys Office.

The following files will be delivered:

4-9.0201 *Planimetric Projects*

The number of files will be dependent on the project size. No files will be greater than 30 MB. All files will have the extension Pln.dgn.

4-9.0202 *DTM Projects*

On DTM projects the binary TIN file will be delivered. The number of files will be dependent on the project size but typically there will only be one file unless the file is greater than 100 MB. The TIN file will have the extension .TIN

4-9.03 *FILE ARCHIVING*

All completed mapping projects put on in the Public folder for the districts retrieval are backed up. The District Surveys Office will be permitted read only privileges to the data so they can retrieve the completed mapping projects. Projects completed prior to December 1994 were archived on tape within the CAES Unit. All archive tapes begin with the letters AR followed by a number. Contact the Photogrammetric Unit for access to these archived files.

The Photogrammetric database contains a field that lists where each project is archived, and if archived by the CAES Unit the applicable tape number. A log book containing the completed mapping index for each project is kept in the Photogrammetric Unit. Besides giving a visual layout of the project, the mapping index also contains the archive information.

Along with the deliverable files a number of raw data files and map accuracy testing files will be stored in the archive directory. This is necessary in case future extensions are requested or a problem with the mapping is discovered and the project has to be reset. The following list of file extensions indicates what files may be archived.

.PLN .TIN .DAT .DTM .3DP .CPG .CPT .TPT .TPG .GPK

A folder called "Accuracy" will also be created in this same location. The "Accuracy" folder will contain the files used to produce the Map Accuracy Report.

REQUEST FOR AERIAL PHOTOGRAPHY

Date: _____

Survey Section Reviewer: _____

Requested By: _____ Phone: _____

MAPPING: <input type="checkbox"/>	NON-MAPPING: <input type="checkbox"/>	PHOTO SCALE: 1" = _____	CO use only ASP: _____ FSM: _____ Item: _____	
S.P.	C.I.D.	T.H.		COUNTY:
NAME OF QUAD MAP(S) OR MAP TECH FILE FOR THIS PROJECT:		APPROX. MILES TO BE FLOWN:		
LOCATION:				
Intended use of aerial flight _____ Are there previous flights in the area? <input type="checkbox"/> YES <input type="checkbox"/> NO If yes, previous ASP: _____ Photography Type: Black & White <input type="checkbox"/> , Color <input type="checkbox"/> , Color Infra-red <input type="checkbox"/>				
IF INTENDED USE IS FOR MAPPING - COMPLETE THE REMAINING FORM				
Is vertical information required on mapping project? <input type="checkbox"/> YES <input type="checkbox"/> NO Have you included any non-mapping areas in a mapping flight? <input type="checkbox"/> YES <input type="checkbox"/> NO				
Please provide your best estimate of mapping limits or area of interest to ensure adequate coverage from our office. Detailed mapping limits need to be submitted on the photo indexes that you will receive. <p style="text-align: center;">(Note: limits submitted should be mapping limits, not photography limits)</p> If this project is programmed, please indicate the letting date: _____ Indicate the type of products that will be required: Ortho Photo (targeted) <input type="checkbox"/> , Rectified Mosaic (Quad Control) <input type="checkbox"/> , Plan &/or DTM <input type="checkbox"/>				
REMARKS:				

Rev: 2/06

FIGURE 4-3.04 REQUEST FOR AERIAL PHOTOGRAPHY FORM

	<p>A.S. P. # : _____</p> <p>Strip No. : _____</p> <p>Exposures: _____ thru _____</p> <p>Checked by: _____</p> <p>Date: _____</p>
<p>S.P. No. _____ T.H. _____ District: _____</p> <p>Location: _____</p> <p>Photo Date: _____ Labeling: _____</p> <p>Flown by: _____ Mapping: Yes _____ No _____</p> <p>Flight Strip Coverage:</p> <p>Side: _____</p> <p>Length: _____</p> <p>Scale: 1" = _____' / _____% Checked on Exposures: _____ thru _____</p> <p>Crab _____ Tilt _____ Tip _____</p> <p>End Lap: Maximum _____% Minimum _____% Average _____</p> <p>Side Lap: Maximum _____% Minimum _____% Average _____</p> <p>Photo Quality:</p> <p>Leaf Conditions: _____</p> <p>Moisture: _____</p> <p>Shadows: _____</p> <p>Fiducials: _____</p>	
<p>REMARKS</p>	<p>SCALE & END / SIDE LAP INFO, COMPUTATIONS</p>

FIGURE 4-3.0803 PHOTOGRAPHY CHECKLIST FORM

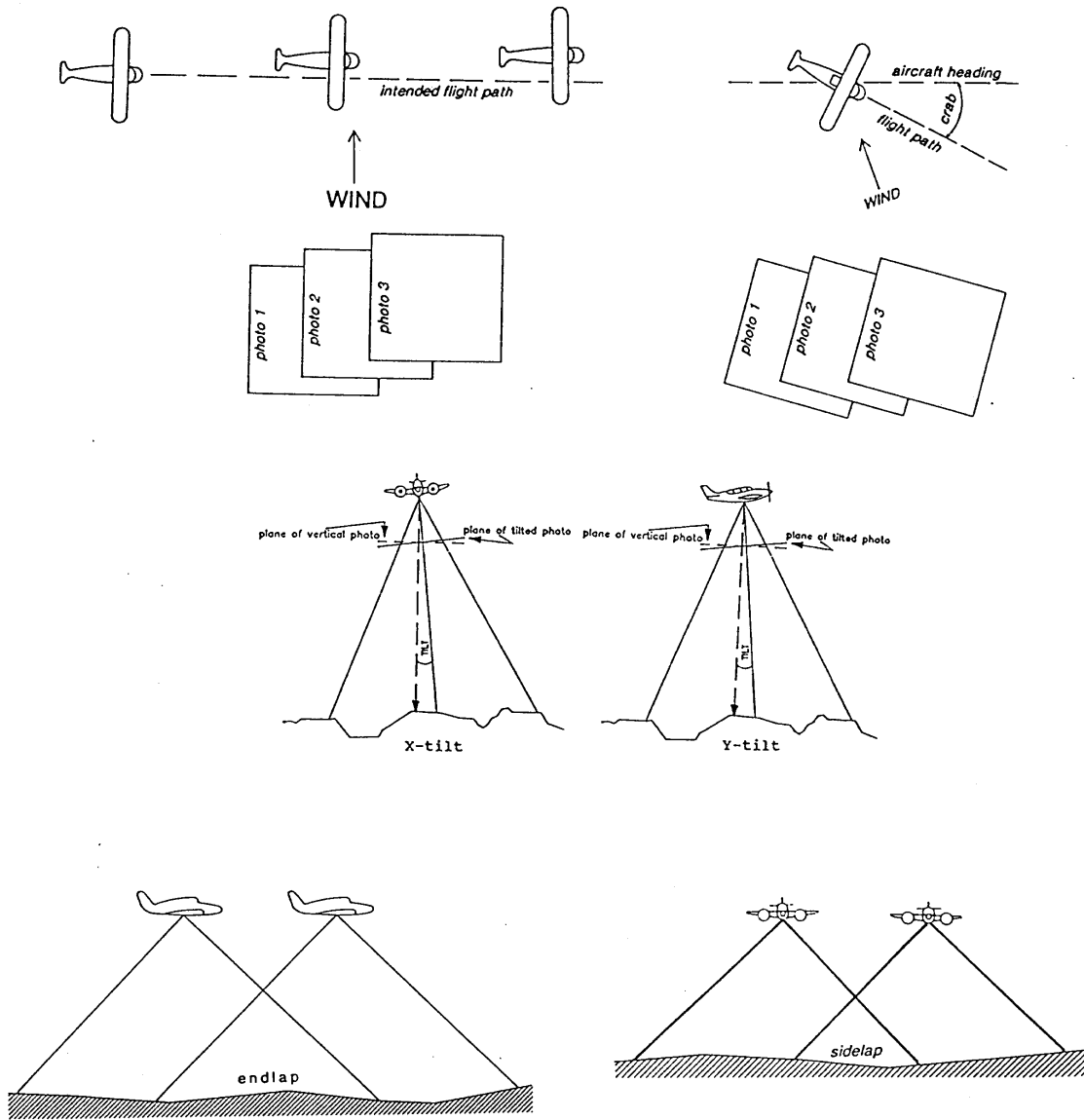
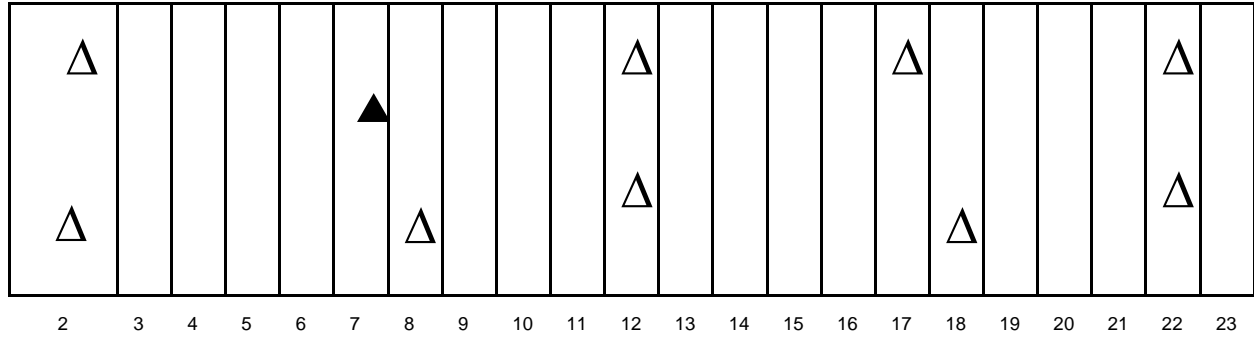

FIGURE 4-3.08303B FLIGHT INCONSISTENCIES

|----- 12,800FT OR LESS ----->



Not to Scale

Reference: Photo Scale 1" = 250'

△ = Horizontal Photo Control Point

▲ = Horizontal Test Target

FIGURE 4-4.0103 SINGLE STRIP - ANY LENGTH - HORIZONTAL CONTROL ONLY



FIGURE 4-4.0104 AZIMUTH DEFORMATION - PLAN VIEW

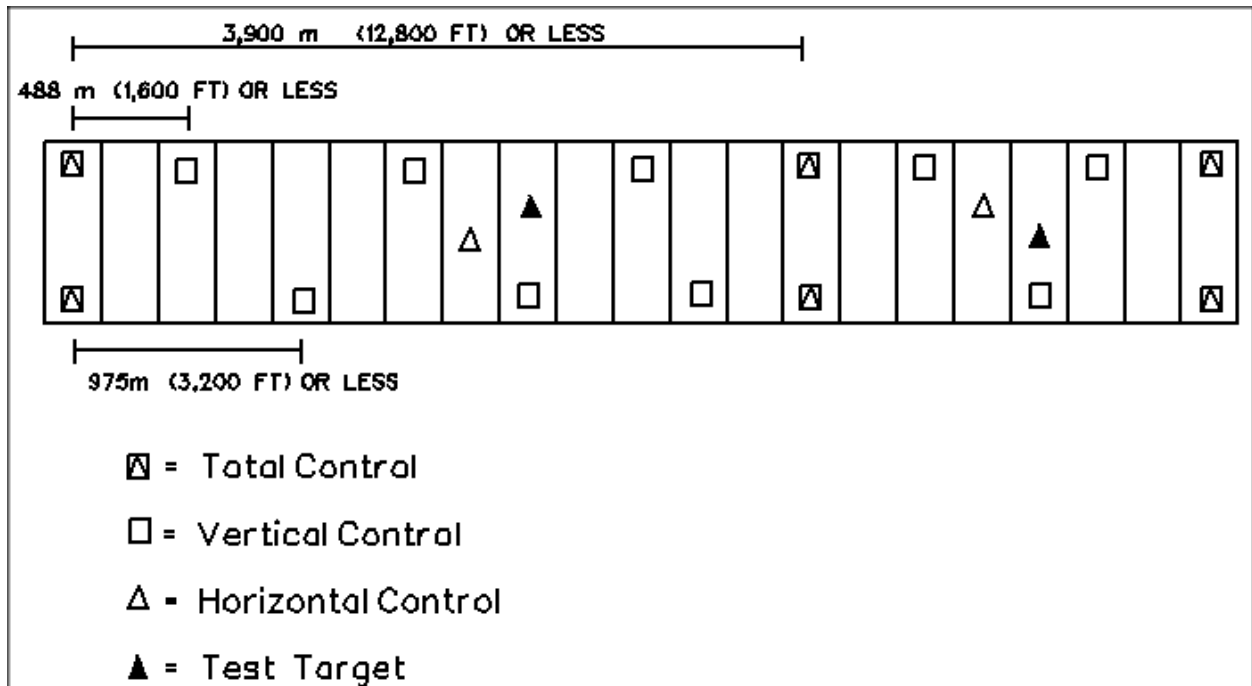

FIGURE 4-4.0105 SINGLE STRIP - ANY LENGTH - HORIZONTAL AND VERTICAL CONTROL

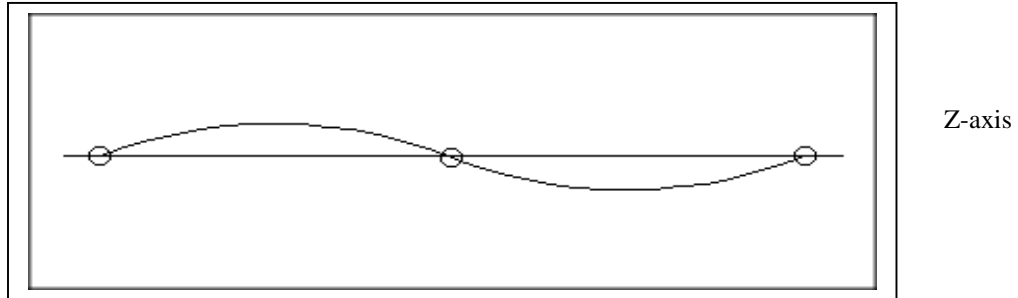

FIGURE 4-4.0106 BOWING DEFORMATION - PROFILE VIEW

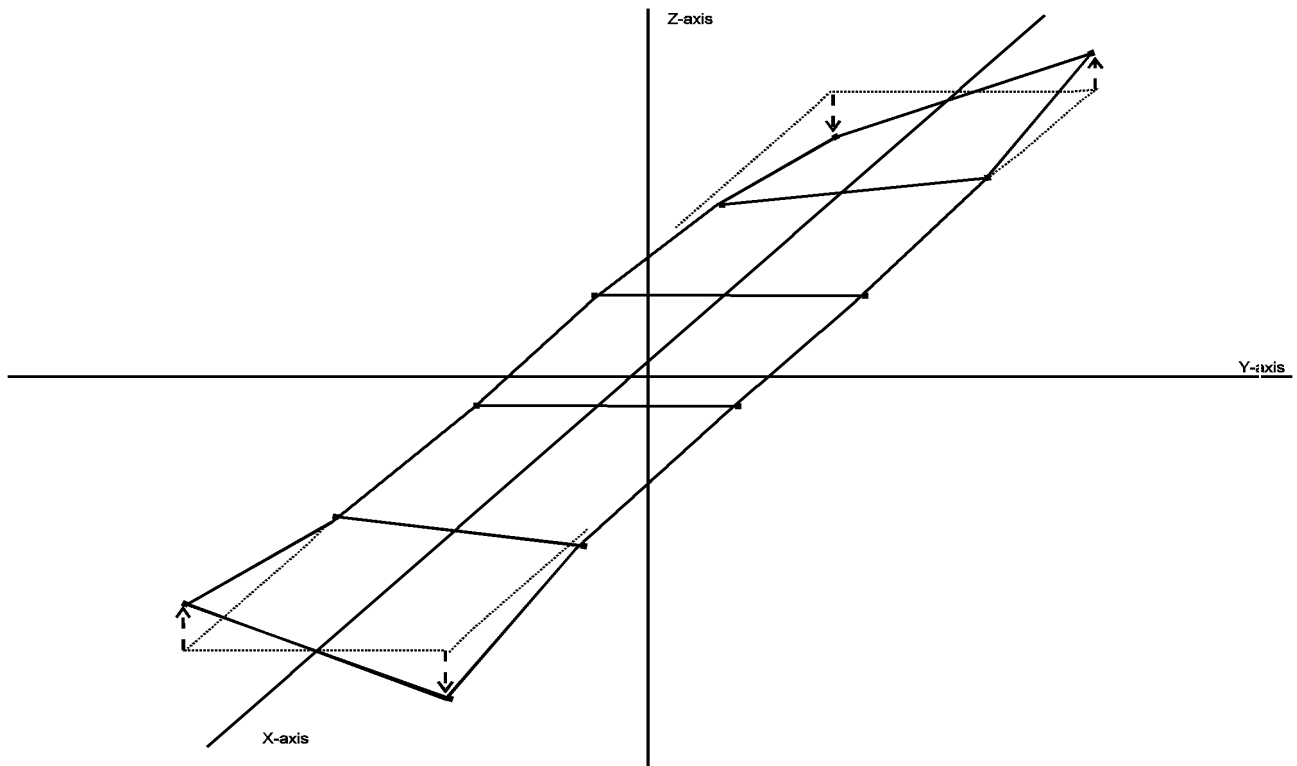

Figure 4-4.0107. Torsional Deformation

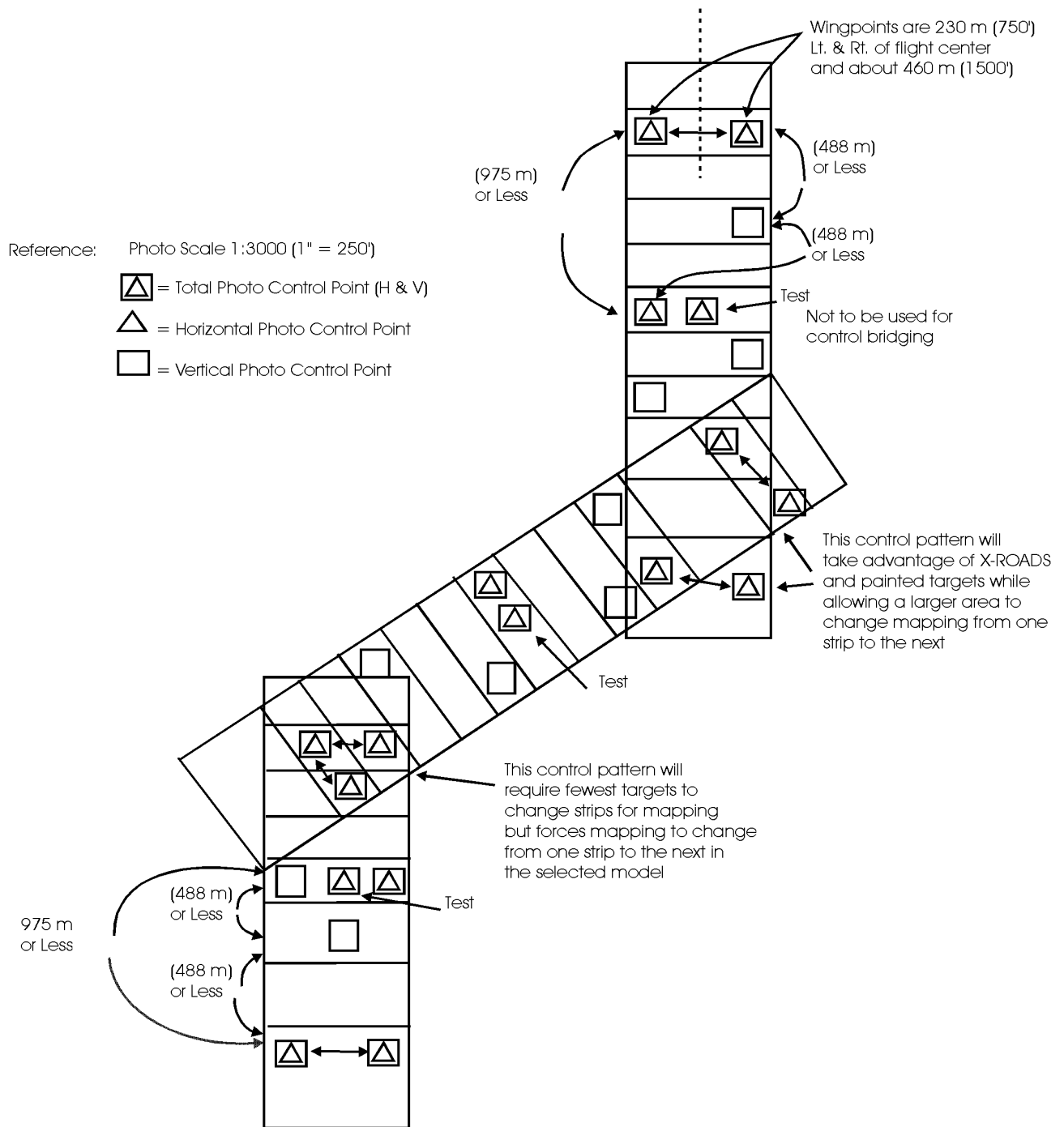
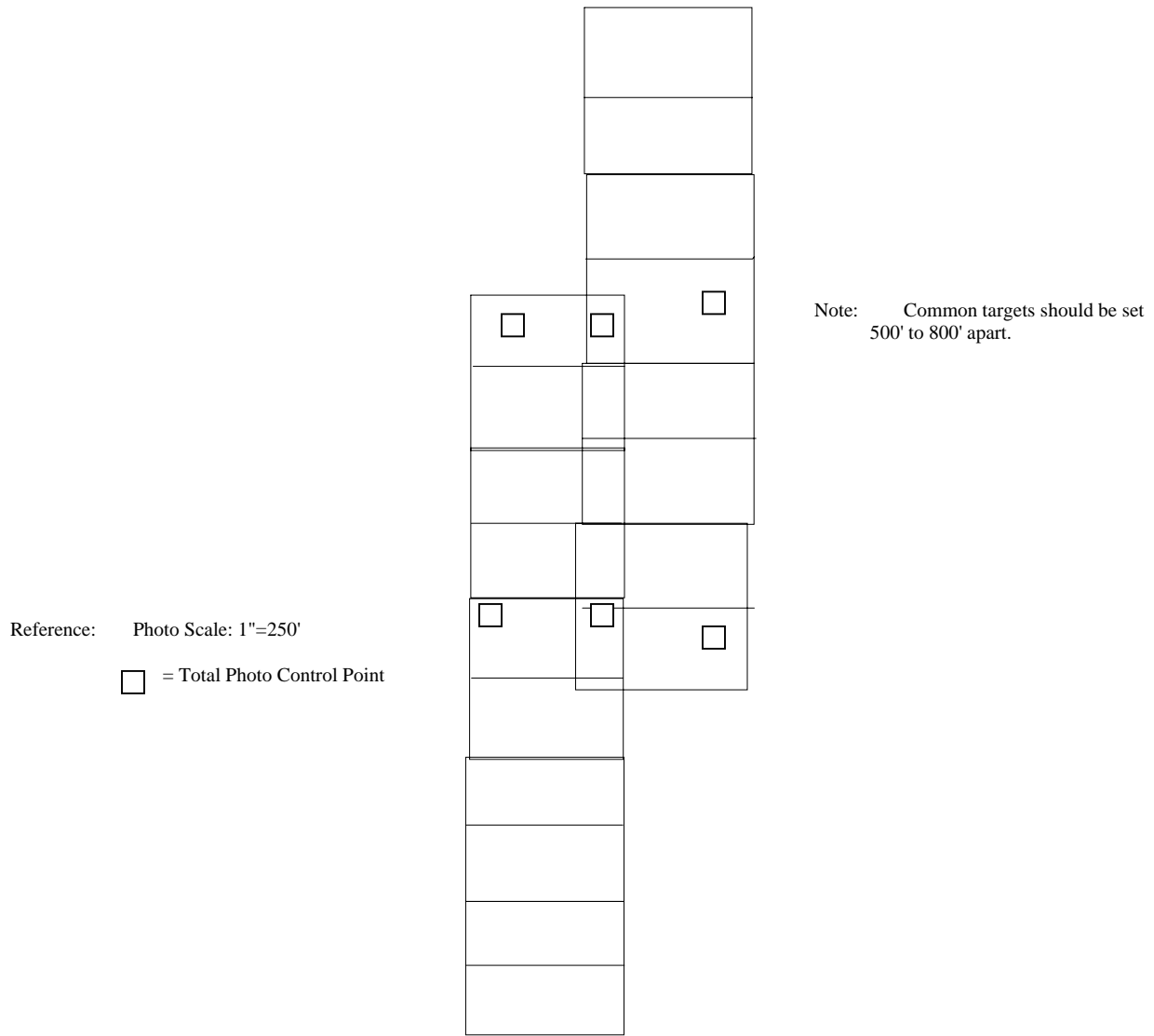
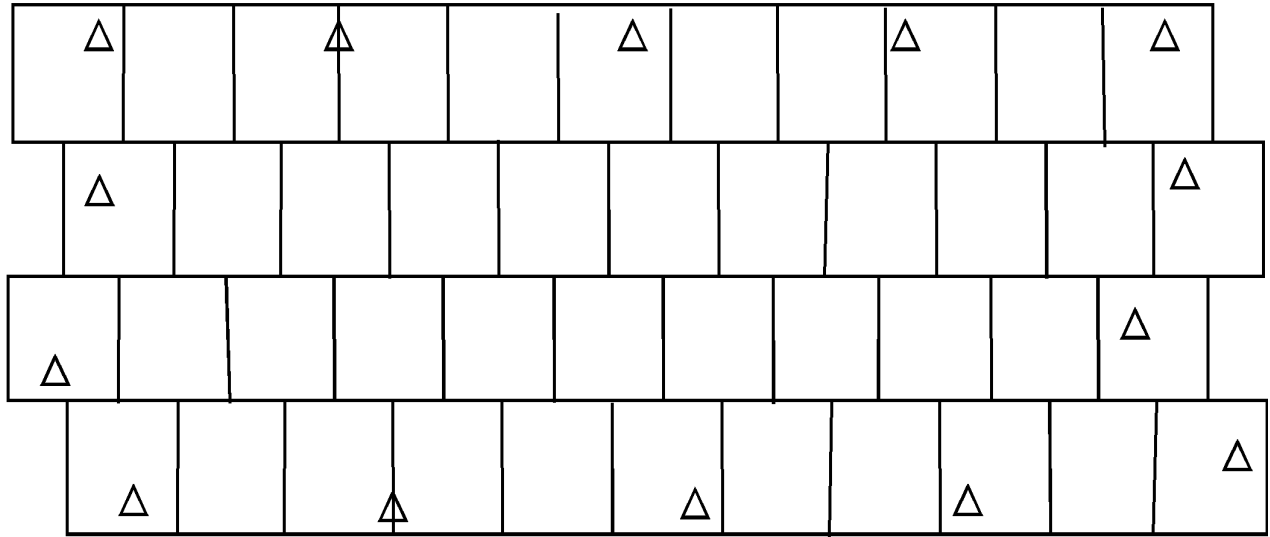

FIGURE 4-4.0108 SUCCESSIVE STRIPS - CONNECTED HORIZONTAL AND VERTICAL CONTROL (NOT TO SCALE)

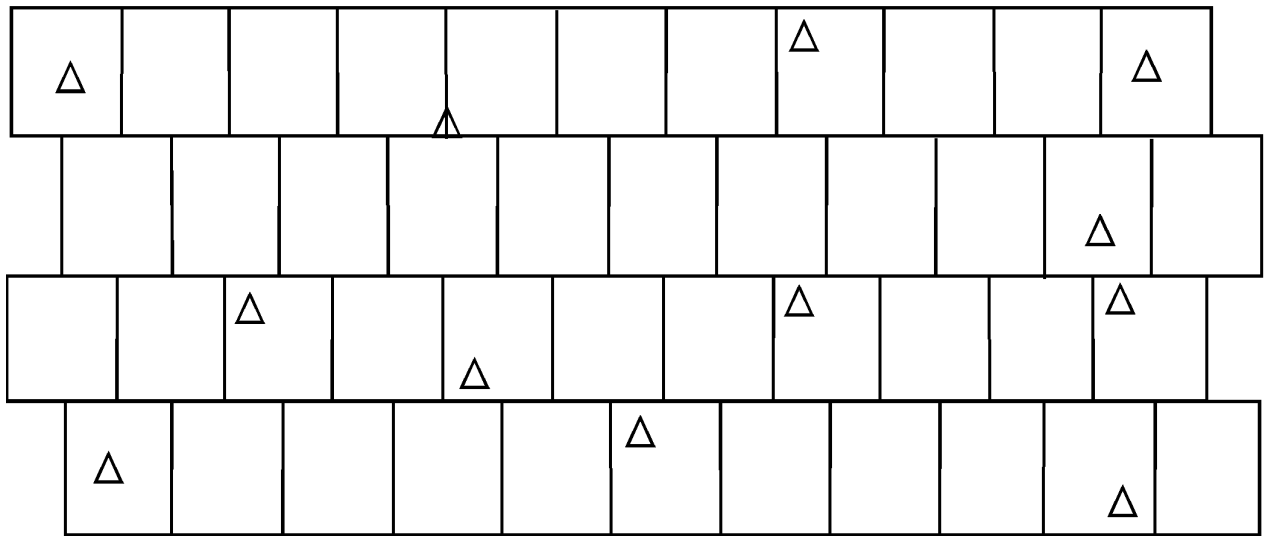

**FIGURE 4-4.0109 SUCCESSIVE STRIPS - OFFSET OVERLAP
(Not to Scale)**

Reference: \triangle = Horizontal Photo Control Point



Horizontal Control - Perimeter Placement



Horizontal Control - Shotgun Placement

**Figure 4-4.0110 Block Photography
Horizontal Control Only**

Reference: Photo Scale 1:3000 (1" = 250')

 = Total Photo Control Point (H & V)

 = Horizontal Photo Control Point

 = Vertical Photo Control Point

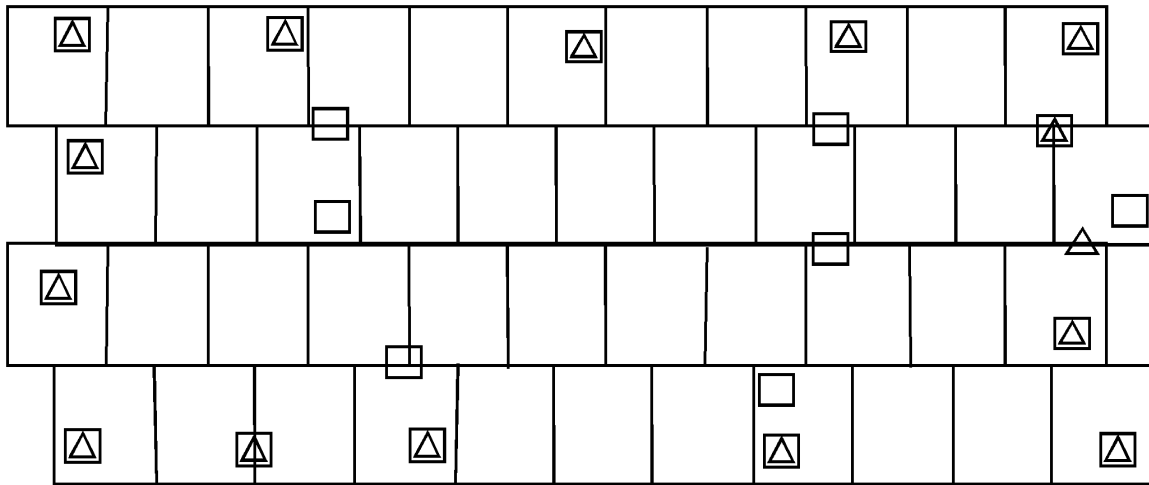

Total Control - Open Terrain Placement

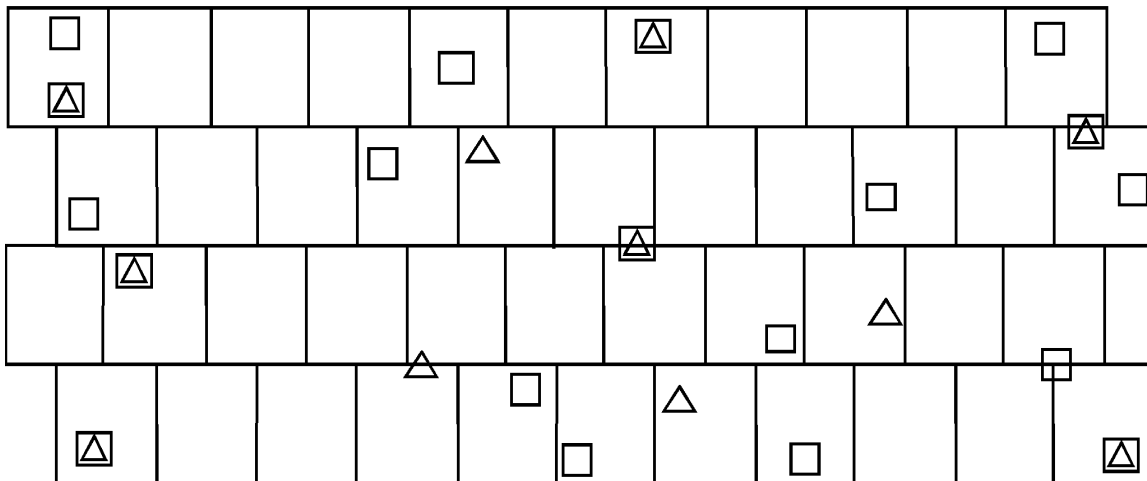

Total Control - Shotgun Placement

**FIGURE 4-4.0111 BLOCK PHOTOGRAPHY
HORIZONTAL AND VERTICAL CONTROL**

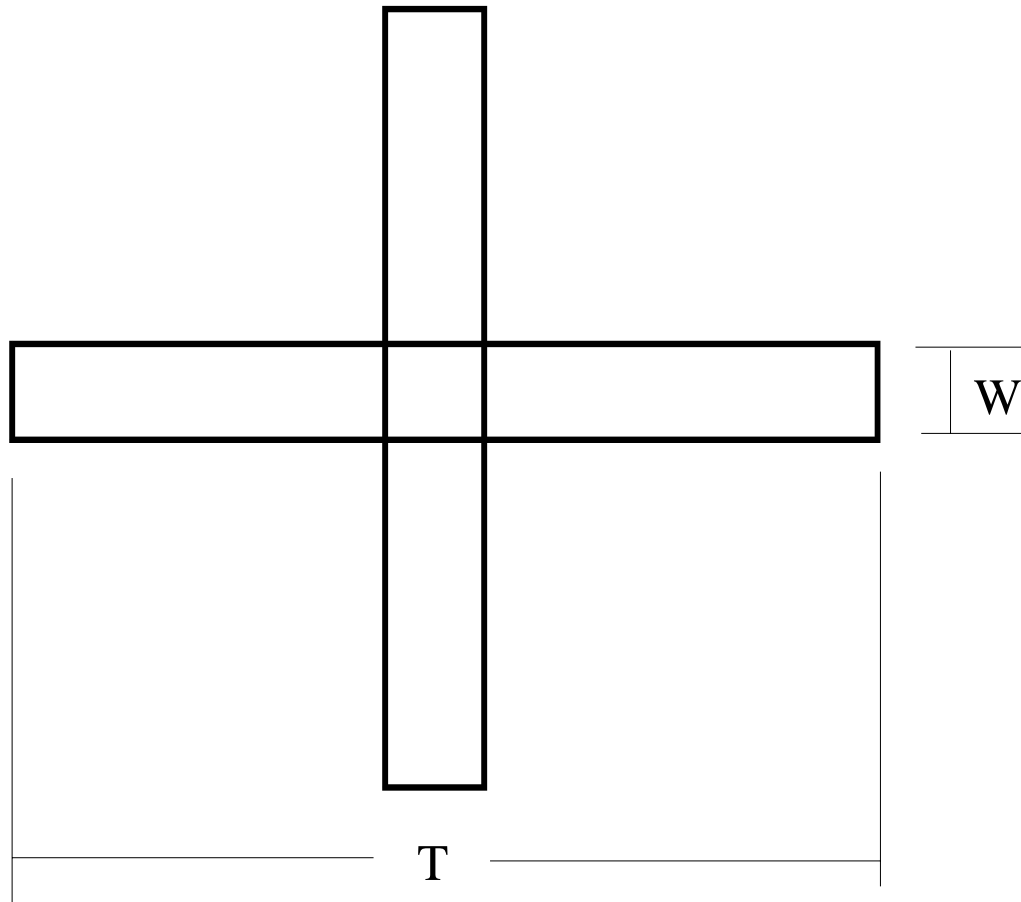

Scale of Photography = Sp
 W = Width of target panel in feet
 L = Length of target panel in feet

$$W = Sp * 0.002$$

$$L = 10 * W$$

Example:
 For 1"=250 scale photography for design purposes.
 $W=250 * 0.002 = 0.5 \text{ feet}$
 $L=0.5 * 10 = 5 \text{ feet}$

FIGURE 4-4.0113 TARGET CONSTRUCTION

REQUEST FOR PHOTOGRAMMETRIC MAPPING

Date submitted _____

S.P.: _____ C.I.D.: _____ T.H. _____ County: _____ ASP#: _____

Location: _____

Approx. Length in miles: _____, Stationing increases from _____ to _____

Please use the following as a checklist for submitting project for mapping.

District Photos submitted with Request (Y/N) _____, Targets marked (Y/N) _____

Target tie sheet submitted (Y/N) _____, Target quad-map submitted (Y/N) _____

TYPE OF MAPPING REQUESTED

Scale: 1"=50' , 1"=100' , 1:500 , 1:1000 , Other (Note: english or metric) _____.

Type of Mapping: Plan Only , Plan & DTM , DTM Only .

TYPE OF DIGITAL PRODUCT REQUESTED

Ortho Photo _____ Rectified Mosaic _____

Typical resolution is 0.5 feet, if other needed please specify: _____

Required Deliver Date: _____ Letting Date: _____

Requested by (name): _____ District: _____ Phone #: _____

Assigned Designer: _____ District: _____ Phone #: _____

Special Instructions: _____

Comments: _____

HORIZONTAL & VERTICAL DATUM

Horizontal Datum: NAD 83(1996) , NAD 83(1986) , Other _____

County Projection & Zone: _____

Vertical Datum: NAVD 88 , NGVD 29 , Other _____

Rev: 5/04

S.P. _____
T.H. _____ COUNTY _____
FROM _____ TO _____
A.S.P. _____
PHOTO SYMBOL: _____
PHOTO SCALE: _____
PHOTO DATE: _____
CAMERA NUMBER: _____
CALIBRATION DATE: _____
CAMERA LENS NUMBER: _____
CAMERA FOCAL LENGTH: _____
FILM CAN NUMBER: _____

FIGURE 4-4.0302 CONTROL POINT LEGEND

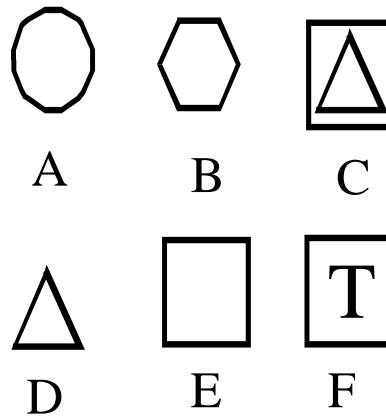

- A. = Pass Points (office processing)
- B. = Tie Points (office processing)
- C. = Total Control (x, y, & z coord.s)
- D. = Horizontal Control (x, y coord.s)
- E. = Vertical Control (z coord.s)
- F. = Triangulated Vertical Control
(Requires x, y positioning)

FIGURE 4-4.0304 CONTROL POINT CHART

TARGET / PICTURE POINT TABULATION										SHEET ____ OF ____									
S.P.	C.I.D.	T.H.	Location:				Remarks												
			Method of Picture Point Control		X, Y	Z					Double Subs, Station Used (File)	Level	Radial Elev.	Traverse					
Target Placement Date, Type, Location Description for Additional Picture Points		Required Picture Point Control		Triangular			Vertical	Horizontal	Level	Radial Elev.					Traverse				
		P. P. Field\			Photo														

FIGURE 4-4.035 CONTROL POINT TABULATION SHEET

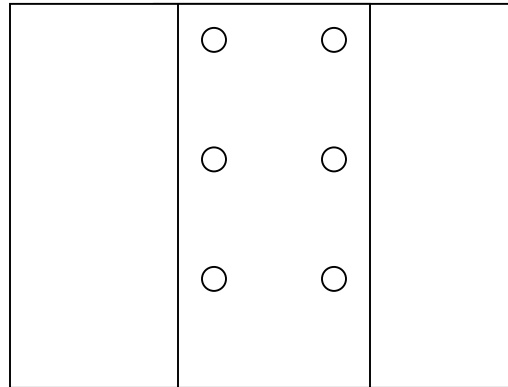

Ideal pug locations for a stereomodel

**CAMERA STATIONS
ANGLES = RADIANS**

STRIP	IMAGE	X	Y	Z	OMEGA(ROLL)	KAPPA(YAW)	PHI(PITCH)
1	21	422109.4631	206909.4438	2796.3208	.0107344	.0114110	3.1920306
1	20	422967.9814	206930.3121	2789.2092	.0036973	-.0023608	3.1899898
1	19	423854.0173	206949.4708	2787.7919	.0098174	-.0041673	3.2012449
1	18	424716.0221	206968.9972	2785.2277	.0058587	.0031332	3.1890971
1	17	425579.4624	206988.0139	2772.9435	.0172712	.0042767	3.1954547
1	16	426446.4974	207003.7208	2765.5174	.0144628	.0001680	3.1845663
1	10	421795.4983	203240.0628	2719.5949	.0320992	-.0096270	4.2685218
2	9	422149.9495	203999.4143	2743.9132	.0245899	-.0273615	4.2664211
2	8	422501.4810	204751.9282	2747.8066	.0279272	.0063797	4.2730668
2	7	422851.0549	205502.6235	2746.9881	.0031285	.0066613	4.2768455
2	6	423210.4745	206283.2941	2746.5341	.0069397	-.0064681	4.2752177
2	5	423561.3866	207046.3378	2758.1566	.0201642	-.0230059	4.2671780
2	4	423912.3798	207809.6239	2770.8777	.0199634	-.0112718	4.2818491
2	3	424265.1522	208570.1632	2770.0342	.0166547	-.0200505	4.2738530

FIGURE 4-5.05 CAMERA STATION FILE

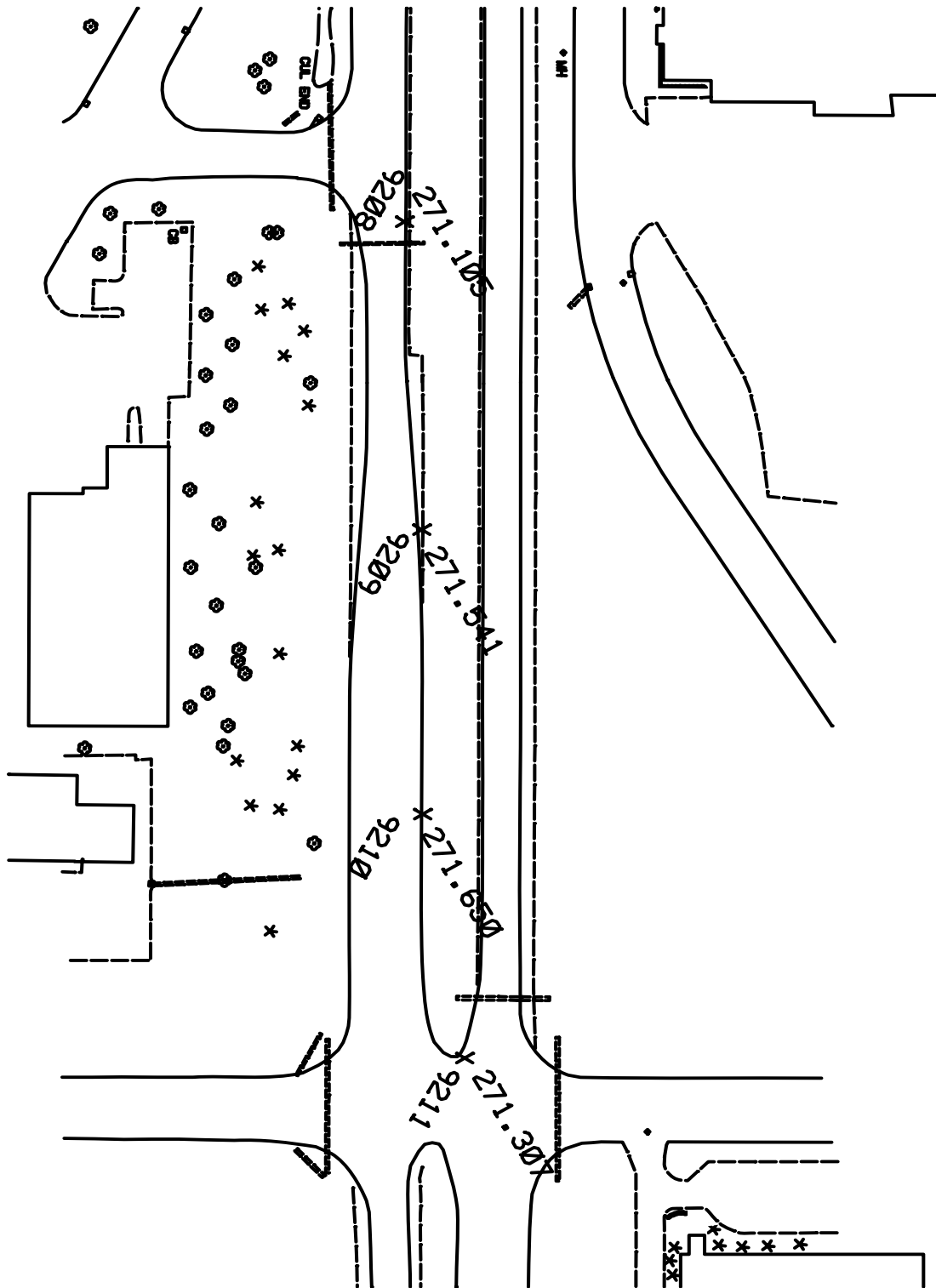

FIGURE 4-6.1501 CENTER POINT DATA

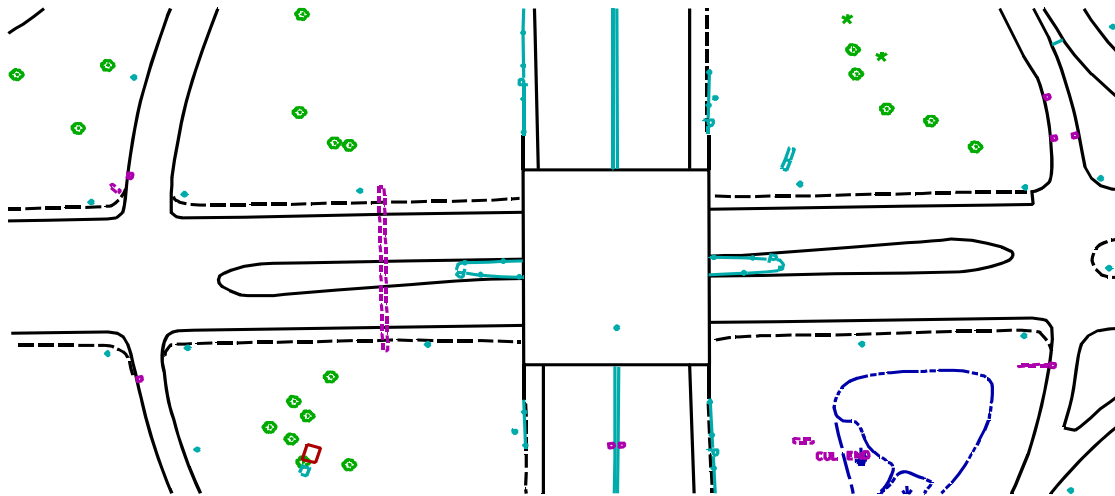
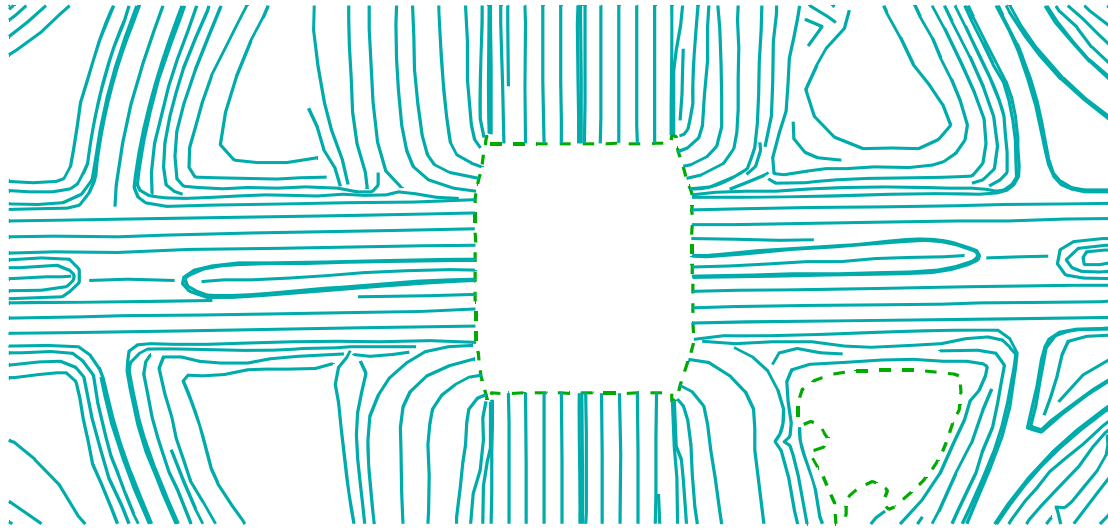

FIGURE 4-6.1502A BREAKLINE PLACEMENT

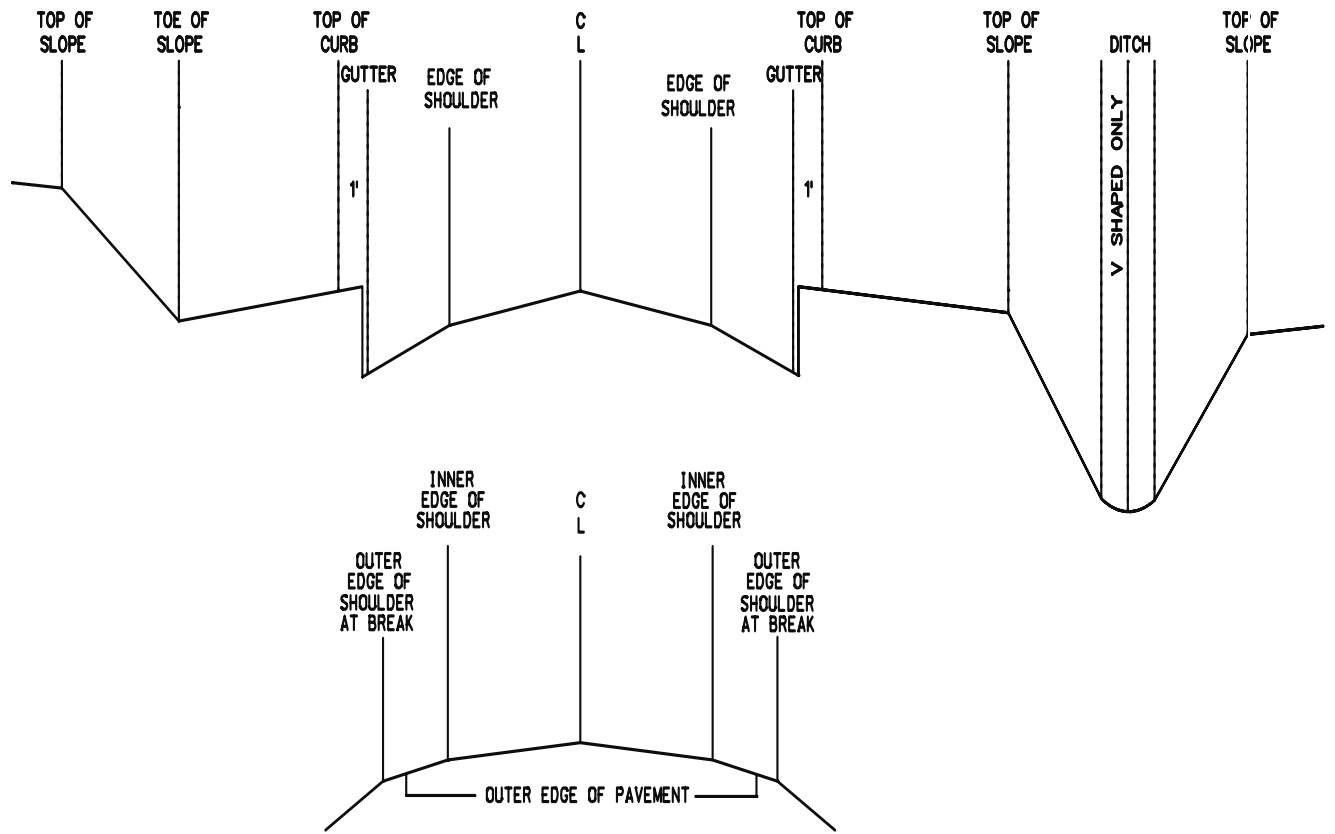
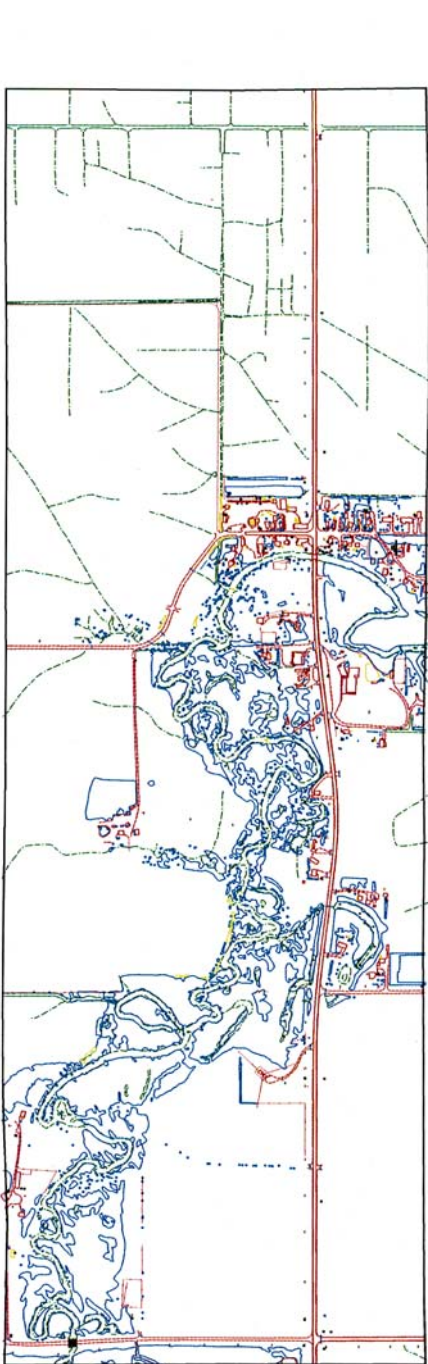

FIGURE 4-6.1502B BREAKLINE PLACEMENT - TYPICAL SECTION



S. P. : 6806-26
A. S. P. : 03S-31
T.H. : 89
LOCATION : BRIDGE AT WANNASKA
MAPPING : PLAN AND DTM
PHOTO SCALE : 1"=250'
MAP SCALE : 1"=100'
CONSULTANT MAPPING : NO
MAPPING COMPLETED : 11-21-2006
ARCHIVE INFO : (651) 296-1081
ARCHIVE TAPE : L/LM/PHOTO/ARC/6806-26/6806-26-RAISED
FILES : PH680626_01PLN.DGN
PH680626_01.TIN

WANNASKA

SO. FORK ROSEAU RIVER

MAP DATUM

The vertical datum of the TIN file associated with this map is based on the North American Vertical Datum of 1988 (NAVD 88).

The horizontal datum of this map is based on ROSEAU county coordinate system which is related to the Minnesota state plane coordinate system NAD 1983 (HARN 1996) adjustment NORTH zone.

MAP ACCURACY

The vertical accuracy of the TIN file associated with this map has been tested using NSSDA (June 1998) methods and computes to 0.36 FT. base on 26 test elevations.

This map has been compiled to meet a NSSDA (June 1998) horizontal accuracy of 1.0 FT.

FIGURE 4-7.07 MAPPING INDEX

EXPECTED VERTICAL ACCURACIES (Feet) Contours / Digital Terrain Models / Cross-Sections						
Photo Scale	Open Ground Uniform Slope		Open Ground Irreg. Slope		Interfering Ground Cover Rolling/Rugged Slope	
	Within 90% +/-	Not to Exceed	Within 90% +/-	Not to Exceed	Within 90% +/-	Not to Exceed
1" = 250'	0.4'	0.8'	0.5'	1.0'	0.8'	1.7'
1" = 300'	0.5'	1.0'	0.6'	1.2'	1.0'	2.0'
1" = 400'	0.7'	1.3'	0.8'	1.6'	1.33'	2.7'
1" = 500'	0.83'	1.67'	1.0'	2.0'	1.67'	3.33'
1" = 600'	1.0'	2.0'	1.2'	2.4'	2.0'	4.0'
1" = 1000'	1.67'	3.33'	2.0'	4.0'	3.33'	6.67'

FIGURE 4-8.02A MAP ACCURACY STANDARDS FOR ENGLISH PROJECTS

COMPARE COGO POINTS TO TIN SURFACE
 TIN FILE: C:\PRJ\TEMP-6806-26\NEW.TIN

POINT	FEATURE	COGO ELEVATION	TIN ELEVATION	ELEV DIFF	LOCATION
10148	TPRO	1110.2770	1110.4043	-0.1273	BELOW
10141	TPRO	1109.3940	1109.0225	0.3715	ABOVE*
10140	TPRO	1103.8370	1103.9448	-0.1078	BELOW
10144	TPRO	1108.3230	1108.2138	0.1092	ABOVE
10150	TPRO	1109.3150	1109.5539	-0.2389	BELOW
10146	TPRO	1108.2620	1108.1831	0.0789	ABOVE
10135	TPRO	1110.0350	1110.1179	-0.0829	BELOW
10143	TPRO	1109.7980	1110.0336	-0.2356	BELOW
10147	TPRO	1108.0970	1107.7205	0.3765	ABOVE*
10149	TPRO	1110.3490	1110.4950	-0.1460	BELOW
10145	TPRO	1108.7750	1108.9984	-0.2234	BELOW
10139	TPRO	1103.6490	1103.7616	-0.1126	BELOW
10138	TPRO	1105.3880	1105.6716	-0.2836	BELOW*
10136	TPRO	1105.6000	1105.8357	-0.2357	BELOW
10125	TPRO	1117.7940	1117.7079	0.0861	ABOVE
10134	TPRO	1110.3790	1110.3110	0.0680	ABOVE
10133	TPRO	1110.6370	1110.7059	-0.0689	BELOW
10132	TPRO	1112.2740	1112.1132	0.1608	ABOVE
10131	TPRO	1110.4940	1110.3448	0.1492	ABOVE
10130	TPRO	1112.3150	1112.1269	0.1881	ABOVE
10151	TPRO	1109.2700	1109.4955	-0.2255	BELOW
10129	TPRO	1113.3580	1113.2906	0.0674	ABOVE
10128	TPRO	1112.3940	1112.3317	0.0623	ABOVE
10127	TPRO	1116.4120	1116.5811	-0.1691	BELOW
10126	TPRO	1117.7850	1117.6695	0.1155	ABOVE
10142	TPRO	1107.7700	1107.7666	0.0034	ABOVE

THE SUM OF (ELEV DIFF)SQUARED = 0.8667

THE AVE OF (ELEV DIFF)SQUARED = 0.0333

THE ROOT MEAN SQUARE ERROR IS = 0.1826

NATIONAL STANDARD FOR SPATIAL DATA ACCURACY(NSSDA) IS = 0.3578

POINTS PASS THE 95% CONFIDENCE TEST BASED ON 1.96 CHI SQUARE VALUE.

USER DEFINED TOLERANCE = 0.5000

11.5% OF POINTS ARE BETWEEN HALF TOLERANCE AND TOLERANCE *

0.0% OF THE POINTS ARE GREATER THAN TOLERANCE ***

-0.2836 IS THE MAXIMUM DIFFERENCE BELOW

0.3765 IS THE MAXIMUM DIFFERENCE ABOVE

26 TOTAL NUMBER OF POINTS

13 POINTS ARE BELOW THE TIN SURFACE

13 POINTS ARE ABOVE THE TIN SURFACE

0 POINTS ARE EQUAL TO THE TIN SURFACE

CHAPTER 5 - LOCATION SURVEYS**5-1 INTRODUCTION****5-2 CHAPTER ORGANIZATION****5-3 ALIGNMENT**

- 5-3.01 INTRODUCTION
- 5-3.02 RECORD RESEARCH
- 5-3.03 RECOVERY OF ALIGNMENT MONUMENTS
- 5-3.04 REESTABLISHING ALIGNMENTS
- 5-3.05 NEW ALIGNMENT
- 5-3.06 FINAL ALIGNMENT
- 5-3.07 REFERENCE TIES
- 5-3.08 ALIGNMENT IDENTIFICATION

5-4 TOPOGRAPHIC SURVEYS

- 5-4.01 HORIZONTAL (PLANIMETRIC) METHODS
 - 5-4.0101 Station-Offset
 - 5-4.0102 Annotation
 - 5-4.0103 Electronic Topography
- 5-4.02 VERTICAL (RELIEF, HYPSONOMETRIC) METHODS
 - 5-4.0201 Profile Method
 - 5-4.0202 Cross-Section Method
 - 5-4.0203 Digital Terrain Model Method
 - 5-4.0204 Contour Method
 - 5-4.0205 Relative Measurements
- 5-4.03 STADIA METHODS
 - 5-4.0301 Transit-Rod
 - 5-4.0302 Theodolite-EDM/Total Station

5-5 SPECIFIC TYPES OF SURVEYS

- 5-5.01 ACCIDENT - TRAFFIC

- 5-5.02 AIRPORTS
 - 5-5.0201 Airport Plans
 - 5-5.0202 Field Procedures
 - 5-5.0203 Vertical Control
 - 5-5.0204 Property Survey
 - 5-5.0205 Alignment
 - 5-5.0206 Profiles
 - 5-5.0207 Contour Map
 - 5-5.0208 Topography
 - 5-5.0209 Drainage
- 5-5.03 BRIDGES
 - 5-5.0301 Alignment
 - 5-5.0302 Vertical Control
 - 5-5.0303 Roadway Profiles
 - 5-5.0304 Roadway Cross-Sections
 - 5-5.0305 Intersection Angles
 - 5-5.0306 Description of Inplace Bridge
 - 5-5.0307 Topography
 - 5-5.0308 Building Elevations
 - 5-5.0309 Adjacent Bridges
 - 5-5.0310 General Data For Hydraulic Engineer
 - 5-5.0311 Normal High Water Elevation
 - 5-5.0312 Determination of Extreme (Highest) High Water
 - 5-5.0313 Water Surface and Stream Bed Profiles for Bridges and Culverts
 - 5-5.0314 Stream Cross-Sections for Bridges
 - 5-5.0315 Stream Cross-Sections for Culverts
 - 5-5.0316 Photographs
 - 5-5.0317 County and Judicial Ditches
 - 5-5.0318 Flood Insurance Studies
 - 5-5.0319 County and Judicial Ditches
- 5-5.04 COMMUNICATION TOWERS
- 5-5.05 DRAINAGE
 - 5-5.0501 Rural Drainage
 - 5-5.0502 Urban Drainage

- 5-5.06 PRESERVATION OF HISTORICAL SITES
 - 5-5.0601 Definitions of Sites
 - 5-5.0602 Mn/DOT Procedure
 - 5-5.0603 Sources of Existing Information
 - 5-5.0604 Minnesota Historical Society Field Study
 - 5-5.0605 District Site Surveys
- 5-5.07 NOISE WALLS
 - 5-5.0701 Baseline
 - 5-5.0702 Cross-Sections
 - 5-5.0703 Topography
 - 5-5.0704 Base Map
- 5-5.08 OVERLAYS
 - 5-5.0801 Alignment
 - 5-5.0802 Perpetuation of Public Land Survey Corners
 - 5-5.0803 Information for Designer
- 5-5.09 PIPELINES
 - 5-5.0901 Ownership
 - 5-5.0902 Product Being Transported
 - 5-5.0903 Pipeline Material
 - 5-5.0904 Pipeline Location
- 5-5.10 PITS
 - 5-5.1001 New Pits
 - 5-5.1002 New Borings in Existing Pits
 - 5-5.1003 Condition Survey of Existing Pits
- 5-5.11 RAILROAD
 - 5-5.1101 Record Research
 - 5-5.1102 Field Procedure
 - 5-5.1103 Alignment
 - 5-5.1104 Vertical Control
 - 5-5.1105 Intersection Angles
 - 5-5.1106 Profiles and Cross-Sections
 - 5-5.1107 Topography
 - 5-5.1108 Drainage
 - 5-5.1109 Glossary of Railroad Terms

- 5-5.12 SIGNAL - TRAFFIC
 - 5-5.1201 Data Required
- 5-5.13 TUNNEL
- 5-5.14 TURN LANES
 - 5-5.1401 Vertical Control
 - 5-5.1402 Topography
 - 5-5.1403 Cross-Sections
- 5-5.15 UTILITIES
 - 5-5.1501 Office Research
 - 5-5.1502 Municipally Owned Utilities
 - 5-5.1503 Privately Owned Utilities
 - 5-5.1504 Field Procedures
 - 5-5.1505 Alignment
 - 5-5.1506 Vertical Control
 - 5-5.1507 Elevations
 - 5-5.1508 Topography
 - 5-5.1509 Profiles and Cross-Sections
- 5-6 MAPPING**
 - 5-6.01 INTRODUCTION
 - 5-6.02 BASE MAP
 - 5-6.0201 Definition
 - 5-6.0202 General
 - 5-6.0203 Map Elements
 - 5-6.03 NATIONAL HIGHWAY MAPPING STANDARDS
 - 5-6.04 GENERAL MAP PLANNING
 - 5-6.0401 Map Leaders
 - 5-6.05 TYPES OF MAPS MADE
 - 5-6.0501 Planimetric Map
 - 5-6.0502 Topographic Map
 - 5-6.0503 Design Map
 - 5-6.0504 Utility Map
 - 5-6.0505 Alignment Map
 - 5-6.0506 Drainage Map

5-6.0507 Staff Approved Layout

5-6.0508 Record Boundaries

5-6.0509 Plats

5-6.06 TYPES OF DOCUMENTS MADE

5-6.0601 Certificate of Location of Government Corner

5-6.0602 Certificate of Survey

5-6.0603 Registered Land Survey

5-6.07 BRIDGE SURVEY SHEETS

5-6.08 GRAVEL PIT SHEETS

5-6.09 SITE MAP

5-6.10 SKETCHES AND EXHIBITS

5-6.11 AIRPORT MAPS

5-7 NOTE FORMS

5-7.01 INTRODUCTION

5-7.02 STANDARDS

5-7.03 FORMAT

5-7.0301 Title Page

5-7.0302 Body of Notes

CHAPTER 5 - LOCATION SURVEYS

5-1 INTRODUCTION

One of the major responsibilities of the District Surveys or Land Management Sections is the collection of field data for the Design and Right of Way (R/W) processes. Accomplishing this task requires complete, accurate, reliable, and properly documented survey information. This chapter will serve to delineate standard procedures to be used and the proper field data to be collected.

Examples of the various forms, field notes, plan sheets, maps, plats, and other graphic files mentioned in this chapter can be obtained at Mn/DOT District or Metro Surveys Offices.

To insure proper scheduling of all work, requests for field surveys or for survey information will be directed to the District Surveys Engineer/Surveyor for review and action. A request for survey can be made on Mn/DOT Form No. 21367 or by other suitable means.

5-2 CHAPTER ORGANIZATION

This chapter is subdivided into five major sections: Alignment, Topographic Surveys, Special Surveys, Mapping, and Note Forms. The first two sections address policy and procedures to collect field data. The third section identifies what data is needed for a specific type of survey. The fourth section is concerned with graphic development and use of the processed survey information. The fifth section is concerned with the documentation of the survey in note form.

5-3 ALIGNMENT

5-3.01 INTRODUCTION

The alignment of existing and new highways is the major control line for most types of records. The perpetuation and monumentation of existing alignment insures a consistent relationship between all previous survey data and any future surveys. Alignment work by Mn/DOT survey crews must meet third order (minimum) accuracy standards as detailed in Section 2-4.04 of this manual and follow proper documentation procedures.

5-3.02 RECORD RESEARCH

The amount of research required will depend on the needs of the project. The following documents may contain useful alignment information:

- a. Final Corrected Plans. Both State and County plans will furnish construction centerline alignment and reference ties of the constructed highways.
- b. Right of Way Map. This map will show the alignment used for the acquisition of property and may or may not be the same as the construction alignment. Care must be taken to identify each alignment and its use.
- c. Alignment and topography notes.
- d. Commissioners Centerline Orders. This order is a written document or map required by statute that may include a description by metes and bounds of the alignment to be used to acquire right of way. It should agree with the right of way map. If it does not agree with the right of way map, further research should be done to determine the alignment used for acquisition of right of way. See Deed or Final Certificate below.
- e. Deed. A written document that, when executed and delivered, conveys an estate in real property or interest therein. Property interests obtained by Mn/DOT through direct purchase will be contained in this document.
- f. Final Certificate. A written document describing land obtained by eminent domain. Property interests obtained by Mn/DOT through a condemnation proceeding will be contained in this document.

5-3.03 RECOVERY OF ALIGNMENT MONUMENTS

All alignment monuments recovered during field surveys will be described and tied for future reference.

- a. Raise any monument recovered below the surface of a road up to the surface of the road to make future recovery easier. (Where applicable, at the discretion of the district surveyor.)
- b. Replace all hubs and non-ferrous monuments with standard Mn/DOT monuments so detection can be made with a metal locator. (Where applicable, at the discretion of the district surveyor.)
- c. Tie alignment monuments with a minimum of three reference ties, and/or tie to coordinate system.

- d. Make new field notes to show recovery information, date, and what was found and/or set along with the above mentioned reference ties and coordinate datum if applicable.

5-3.04 REESTABLISHING ALIGNMENTS

When reestablishing P.I. monuments that cannot be recovered, it is the surveyor's responsibility to restore the monuments as near as possible to their original positions. Reestablishment should be based on a thorough analysis of the existing evidence before replacing the missing monument.

- a. Obtain coordinate positions on any existing alignment points or centerline shots using a third order traverse or other methods, and use them to compute the coordinate positions of missing monuments. Coordinates should also be computed from the plan alignment data. Comparing these two positions will help to determine the best locations for the missing points.
- b. The reestablished P.I. will usually result in a new, slightly different intersection angle. Generally, when this occurs, use the original tangent length and compute new curve data. Some surveyors hold the original radius fixed instead of the tangent length.
- c. Generally there will be differences between the recorded/plan distances from PI to PI and the new measured PI to PI distances. Equations will be included to reflect these differences and should be located to preserve as much of the original stationing as possible.
- d. When collecting field information on railroads, county roads, airports, pipelines, etc., their stationing and alignment should be used and shown on Mn/DOT maps and plans.

5-3.05 NEW ALIGNMENT

New alignments can be located in the field using the following methods:

- c. By using the coordinate positions of points from alignments computed by consultants or Mn/DOT design units.
- a. By scaled position of alignment points from topography shown on layouts and other mapping. When these points have been set on the ground, coordinates to these points must be obtained by traverse or other field methods necessary to compute alignment data.
- b. By scaled coordinate position of alignment points from the coordinate grid shown on mapping. These coordinates will be used to compute alignment data prior to point set out.

All new alignment points require proper reference ties and documentation.

5-3.06 FINAL ALIGNMENT

- a. Right of Way and construction alignment P.I.s, P.C.s, P.T.s, and P.O.T.s destroyed during construction operations will be re-monumented. A new set of notes covering the project with proper monument descriptions and reference ties may be made.

- b. On multi-lane construction with parallel centerlines, only one centerline needs to be monumented.
- c. On two-lane construction where the centerline has been shifted uniformly to provide additional width, monument the new centerline and make reference to the shift in the notes.
- d. Final alignment should be referenced to the Minnesota county coordinate system, tied to monuments within the Mn/DOT Geodetic Database.

5-3.07 REFERENCE TIES

While swing ties were typically used in the past to perpetuate or locate alignment monuments, horizontal coordinate ties are now used almost exclusively.

5-3.08 ALIGNMENT IDENTIFICATION

All notes will be identified with the alignment used as a baseline for the survey. The following coding will be used.

- a. Preliminary line - The letter P will code the first line run. Subsequent lines will be labeled P1, P2, P3, etc.
- b. Location line - The letter L will code the first line run. Subsequent lines will be labeled L1, L2, L3, etc.
- c. Office Revisions - The letters LOR will code the first revision. Subsequent revisions will be labeled LOR1, LOR2, LOR3, etc.
- d. Old line notes - These lines were often identified by using the beginning letter of the last name of the location engineer, such as LC for line by Chase, LPF for preliminary line by Fischer, etc.

5-4 TOPOGRAPHIC SURVEYS

The American Congress on Surveying and Mapping (ACSM) defines topography as, “The features of the actual surface of the earth considered collectively as to form. A single feature such as a mountain or valley is termed a topographic feature. Topography is subdivided into hypsography (the relief features), hydrography (the water and drainage features), and culture (man-made features).”

ACSM also defines a topographic survey, “A survey which has for its major purposes the determination of the configuration (relief) of the surface of the earth (ground and the location of natural and artificial objects thereon).” Topographic surveys are based on plane surveying techniques that ACSM defines as, “A branch of the art of surveying in which the surface of the earth is considered a plane surface. For small areas, precise results may be obtained with plane surveying methods, but the accuracy and precision of such results will decrease as the area surveyed increases in size.”

The actual location of topography can be accomplished by using either aerial photogrammetry methods or ground survey methods. This section will explain the common methods used to gather the topography with ground methods and present it in a form that the mapper or designer can use. When photogrammetric methods are used to collect topography, a certain amount of ground survey work is still necessary for control and checking purposes, which is covered in Chapter 4 of this manual.

The surveyor should start by analyzing all existing maps, plans, and field notes to determine if they can be used to supplement the proposed survey. Sources of information include the following:

- a. District Construction Log
- b. District Survey Files
- c. District Design & Plans Files
- d. District Permits Files
- e. Private and County Surveyors
- f. County Engineers
- g. Municipalities
- h. Consulting Engineers
- i. Railroads
- j. Utility Companies
- k. Federal Agencies

This research data will indicate what kinds of features are present within the survey limits. Information requests from agencies outside Mn/DOT should be presented in written form.

The next step is to recover and correctly identify the features. Identification should include the type, size, and/or dimensions of the feature. Mn/DOT manuals contain proper nomenclature of all features, especially when working with railroads, bridges, and utilities.

The topographic base map should be prepared or annotated in the Surveys Section, so there is direct communication between the field party and the mapmaker. Photographs may clarify special features for design use.

Field data must be analyzed, reduced, adjusted, and plotted as maps or plans before the survey is complete. On large projects the surveyor should meet with the designer and review the data being presented.

5-4.01 HORIZONTAL (PLANIMETRIC) METHODS

According to Francis H. Moffitt and Harry Bouchard in **Surveying**, “Topographic surveying is the process of determining the positions on the earth's surface, of the natural and artificial features of a given locality, and of determining the configuration of the terrain. The location of the features is referred to as topography.”

The purpose of a topographic survey is to gather data necessary for construction of a graphical scale portrayal in the form of a plat or planimetric map. The actual location of the planimetry or topography can be accomplished by using either aerial photogrammetric methods or ground (field) survey methods.

Chapter 4 of this manual gives a detailed explanation of the use of aerial photography in the preparation of a planimetric map. A certain amount of ground survey work is required in the control and checking of photogrammetric methods, which is also covered in Chapter 4.

Aerial photography is the most efficient method for obtaining large volumes of planimetric data. However, it does require advance planning and more lead-time than ground methods.

The following are standards for all topographic data collection methods:

- a. Unless specifically requested otherwise, measure all topographic features to the nearest 1 ft.
- b. Usually the distance is measured to the center of the object or topographic feature. However, distances are measured to the faces of buildings and trees and the backs of curbs in urban areas
- c. Measure a concrete culvert with aprons along the flow line from end of apron to end of apron, and indicate in the notes that the length includes aprons. If a concrete culvert has no aprons, measure the barrel length, and indicate in the notes that aprons were not present. Measure a metal or plastic culvert along the flow line from end of barrel to end of barrel, and indicate in the notes whether aprons should be added to the length. Measure both the span and rise for pipe arch.
- d. Include in the comments, notes, or in tabulation form the condition of all pipe culverts within possible construction limits. This will help to determine which culverts can be reused.
- e. Measurements to 0.1 ft will be made to utilities when it is not clear if they occupy existing highway right of way. The position of the utility will affect the cost assessed when a move is required for a construction project.
- f. It is very important that ownerships of all utilities surveyed are shown in the comments or notes, so proper notification can be made with regard to any proposed construction work.

The remainder of Section 5-4.01 discusses three field methods for locating and compiling planimetric features, Station-Offset, Annotation, and Electronic Topography.

5-4.0101 Station-Offset

The planimetry (topography) may be referenced to the survey line by recording the station plus and the distance out, at right angles to the survey line, to the feature. Normally this survey line is the centerline alignment (see Section 5-3) but could be any referenced survey line. In some cases, such as working under traffic, it is safer and more economical to offset the survey line parallel with the centerline alignment or to run a random survey line by coordinates in order to take the topography.

Using a random straight line as a baseline has the advantage of eliminating curves, so that the right angle offset is likely to be more accurate than those taken on curves. One disadvantage of random baselines is that the field notes may be confusing for some users who expect the topographic notes to reference the “actual” alignment.

Basic principles followed in the station-offset method of taking topography are similar to the procedures used in cross-sectioning.

5-4.0102 Annotation

Annotation is a process by which survey data is identified and explained using standard symbols and abbreviations. Annotation includes a field check to verify the map compilation on the ground.

A blue line copy of the aerial mosaic, base map, planimetric map, or topographic map is used by the survey crew for their working copy when making the field check. The actual station-offset, azimuth-distance, or dimension can be kept right on the blue line copy. Drawing new features to scale on the blue line sometimes helps to highlight these additions.

This annotated blue line work copy also provides the draftsman with the opportunity to set up a color check-off system as the annotation is added to the original base map.

Another method would use laptop computers with the field crew entering the necessary information into a referenced copy of the aerial mapping file.

5-4.0103 Electronic Topography

Electronic topography is a process using an electronic total station and a data collection system to collect topographic data. This process is explained in Section 5-4.03, “Stadia Methods”. The use of Global Positioning System (GPS) equipment and techniques is another form of electronic topography.

5-4.02 VERTICAL (RELIEF, HYPSONOMETRIC) METHODS

Relief is the variation in the elevation of the ground surface. On a topographic map, relief is depicted by hatching or shading, or, more accurately, by contours or by spot elevations or both.

Unless there are compelling reasons to do otherwise, always tie vertical features to the North American Vertical Datum of 1988 (NAVD 88). Avoid using assumed elevation datums.

Vertical measurements are usually required for proposed construction areas or locations where in-place drainage or grade differentials are required. The object of vertical measurements of features is to quantify their relative elevation differences, compute volumes and areas, or prepare topographic maps.

Some of the factors to be considered in selecting a field method for compiling vertical information are: map scale and accuracy, contour interval, type of terrain, people and equipment available, existing control, extent of area to be mapped, and type of project.

The field survey crews may accomplish the measurement or establishment of the vertical differences by several different methods:

- a. Profile
- b. Cross-Section
- c. Digital Terrain Model
- d. Contour
- e. Relative Measurement

Elevation differences are usually measured in the field to the nearest 0.1 ft on natural ground and to the nearest 0.01 ft on all man-made features.

5-4.0201 Profile Method

“A profile is a vertical section of the ground, including natural and artificial features, along a survey line.” A profile may also represent the relative elevation differentials of the same elements (top of water, natural ground, future finished centerline, etc.) along a given horizontally fixed line.

For a description of the survey line used for most profiling see Section 5-3, “ALIGNMENTS”. An example of a survey line that may be used is a horizontal line between two fixed planimetric features, such as a straight line from a power pole to a tree. This can be a random line whose position is known and can be shown on any mapping. It is equally important to be able to reestablish this line at some future date, so it should be referenced to monuments related to the county coordinate system.

The field profile consists of the individual rod readings referenced to the line by measuring the distance along that line from the last station mark. This distance is called the plus distance.

The plotted profile is the graphic representation of the field profile. Various profiles of different elements may be shown on the same graphic view so as to get an overall view of the relationships of the in-place and/or proposed elements.

The field survey crew, when running profiles, should measure elevations to all high and low points crossed, breaks (sharp changes) in the ground, top and bottom of all vertical features (walls, cliffs, curbs, etc.), drainage structures that are on the profile line, and at all changes of element (edge of concrete or bituminous).

Individual profile shots should not be spaced more than 50 ft apart in urban areas or 100 ft apart in rural areas. Each individual shot, if taken on other than natural ground, shall be described as to type of element and nature of structure (top pre-cast concrete manhole, edge of concrete curb, etc.). The description shall be placed on the right hand side of the field notes, with the stationing and plus (line reference) on the left side and the shot (rod reading) near the center of the left hand page.

Profiles may also be taken utilizing electronic topography methods, or by conventional methods using electronic data collection.

5-4.0202 *Cross-Section Method*

A cross-section is defined as a short segment of profile, of varying length, taken at right angles to a base line or alignment. Cross-sections are most often used to determine volumes, but may also be used to depict in-place relief, determine contours, and show perspective views or profiles.

Plotted cross-sections can be used to determine areas and volumes or to show graphical views of past, in-place, or proposed vertical sections.

Field cross-sections are generally taken by the survey crew when earthwork volumes (proposed construction) are to be computed, hydraulic volumes are to be determined, or the in-place relief is needed. The cross-section limits should extend a minimum of 33 ft beyond the proposed edge of construction or R/W width, whichever is wider. Cross-sections should never end on a steep slope. A preliminary profile grade furnished by the designer helps determine the cross-section width needed.

Field cross-sections are usually taken at:

- a. Fixed intervals along the reference line.
- b. Breaks in the relief (ground) along the reference line.
- c. Breaks in the relief or fixed grade lines (streets, driveways, etc.) to the right or left of the reference line, within the limits of the area to be surveyed.

The usual maximum interval between cross-sections when taken along the reference line is 100 ft. There are some cases where cross-sections may be taken at larger intervals: very flat terrain, long swamps with thick brush vegetation and uniform peat depths, overlay projects, or shoulder grading projects. In such cases, variations in interval should be discussed with and agreed to by the designer. The maximum distance between the individual shots in the cross-section segment should be 25 ft.

Cross-sections must be laid out carefully at right angles to the base line or reference line to insure proper orientation. There are various ways to accomplish this, such as using total station alignment software, turning the right angle with a station instrument, setting a point on the extended section from a coordinate control station, or running an offset line.

In areas of greater elevation than the Height of Instrument, the readings shown in the notes shall be the measured vertical difference from the instrument elevation to the shot elevation. These readings are marked with a plus sign to indicate they must be added to the elevation of the instrument.

Cross-sections may also be taken utilizing electronic topography methods or by conventional methods, using an electronic data collection system.

5-4.0203 *Digital Terrain Model Method*

Digital terrain modeling means building a mathematical model of a portion of the earth's surface. A model consists of a set of triangles, each corner of which is an actual ground position and elevation. Ground shots may be taken as spot elevations or as elements of break lines. Both kinds of shots are used to build triangles, but break lines are used at abrupt terrain changes to prevent triangles from being constructed across them.

This method can be used to compute contours, cross-sections, and volumes. When using this method for volume computation, an original model is overlaid with a final model, the volume being the difference between the two surfaces. Care must be taken to extend the original model beyond the area that will be excavated or filled.

The frequency of ground shots will be determined by the character of the terrain. Rough terrain will require more shots, flatter terrain fewer. The terrain also will determine the number and position of break lines needed.

5-4.0204 *Contour Method*

The contour method is defined as a method of showing the relief of a given surface area by imaginary lines connecting points of equal elevation. The generation of contours is best accomplished by using digital terrain models compiled either from the TIN files produced by the Photogrametrics Unit or by field methods.

The individual contour lines are usually spaced by a uniform, equal elevation difference. Contour lines either begin or end on the edge of the mapped area, or they must close upon themselves so as to form a continuous unbroken line. Areas where contour lines are close together represent sharp vertical differences, and areas where contour lines are widely spaced represent flatter areas.

Contours are best suited to graphic representation of elevation differentials on area mapping where three-dimensional features are to be shown, since they depict shapes of relief as well as amounts of change.

5-4.0205 *Relative Measurements*

This method is used to determine any vertical differential, where it is not necessary to relate elevations to a datum, such as documenting pay heights of catch basins or grades of culverts.

The field notes for this procedure vary greatly and may consist of diagrams, cross-sections, or a profile views, or they may be in the note forms of previously described methods.

5-4.03 **STADIA METHODS**

The stadia method is used on topographic, hydrographic, and other surveys to collect data for plotting maps. It is far more rapid than taping, and under certain conditions is as precise. This method is used to determine the vertical and horizontal location of any feature by measurements of angles and distances from points of known position.

Mn/DOT used transit-rod methods in the past, but all current work uses total station methods. The basic difference between these methods is the accuracy they provide, the transit-rod method being much less accurate.

5-4.0301 Transit-Rod

The transit-rod stadia method of collecting information is no longer utilized in Mn/DOT surveys, but it was used for many years in the Department. For a time it was used almost exclusively for pit surveys, but its use expanded to other areas where less than third order accuracies were needed.

5-4.0302 Total Station

Surveying with electronic survey equipment is well suited to collecting and furnishing survey data for Mn/DOT's Computer Aided Design and Drafting (CADD) system. The ease of measuring, collecting, and computing data with high accuracy makes this method preferable. Proper documentation of a topographic survey may require additional descriptions or a sketch to clarify unique conditions.

Electronic survey equipment can determine the horizontal and vertical positions of any feature, with third order accuracy, if the following standards are followed:

- a. When a traverse is being run, both beginning and ending traverse stations shall have horizontal and vertical position to third order accuracies.
- b. When locating topography with elevations, the distances should not exceed 1000 ft.
- c. To maintain acceptable vertical accuracies, the instrument should be in adjustment. Follow the proper adjustment or collimation procedures on a regular schedule.
- d. Vertical measurements require a target height accurate to 0.01 ft. The recorder should be notified of the target height for each observation.

5-5 SPECIFIC TYPES OF SURVEYS

5-5.01 ACCIDENT - TRAFFIC

The Department of Public Safety and the Mn/DOT Traffic Section may request field survey data and mapping at vehicle accident locations on trunk highways or at roads approaching trunk highways.

The purpose of the survey is to provide documentation of the existing topography, profiles, and alignments at the scene of the accident. Field notes must be complete and clear and must meet the standards of accuracy required by the requesting agency. These notes may be used as an exhibit, and the surveyor may be required to appear in court.

These surveys are now, usually performed by trained Highway Patrol personnel.

5-5.02 AIRPORTS

Airport surveys may be needed when an airport, or any portion of an airport facility, clear zone, instrument landing system, or runway approach area is adjacent to proposed highway construction or reconstruction.

Airport surveys may be performed under a Technical Services Agreement for local public agencies. An airport survey of this type must be very complete, since it will be used for airport design and construction.

5-5.0201 *Airport Plans*

Airport layout diagrams are available from the Office of Aeronautics. The airport layout diagrams are drawn at a scale of 1"= 1320' (1:15840) and contain the following information for the airport:

- a. Airport name and a site map showing location with respect to a nearby city or lake (seaplane base).
- b. Field elevation to the nearest 0.1 ft.
- c. Latitude and longitude.
- d. Runway length, width, type of surface, and magnetic azimuth numerals.
- e. Height of towers or other nearby hazards.
- f. Roads, railroads, trails, and open ditches.
- g. Taxiways.
- h. Telephone and power lines.

The Office of Aeronautics may have plans of previous airport construction on file that would be helpful to the surveyor. Aeronautics can supply the surveyor with an airport development plan that will show the recommended improvements for the airport and the year of proposed construction. A city Department of Public Works or Airport Commission may have airport construction plans on file and can advise the surveyor of planned construction.

5-5.0202 Field Procedures

Before any survey work is begun at an airport site, permission to enter onto the airport with survey equipment and personnel must be obtained from the airport manager. Each and every time survey work is performed on runways, taxiways, and other related facilities, the work session must be approved by the controlling authority. This approval is required to assure that no hazard is encountered by aircraft on the ground or in flight. It may be necessary for survey personnel to have two-way radio communications capability to minimize the hazards to surveyors and aircraft. Electronic instruments may affect the instrument landing systems installed at some airports, creating a false instrument indication in the aircraft.

5-5.0203 Vertical Control

Establish suitable benchmarks (BM) for the survey and construction of the airport site. Do not use assumed elevations, but establish BM elevations based on the North American Vertical Datum of 1988 (NAVD 88) unless specified otherwise.

5-5.0204 Property Survey

Obtain the following field data:

- a. A survey should be made of the airport boundary, if not surveyed previously. This boundary survey should be tied to Public Land Survey System (PLSS) corners by distance and bearing, in accordance with property survey standards, and related to the county coordinate system if available.
- b. Identify the rights of way for roads and utilities.
- c. Identify the intersection of the extended runway centerline and property lines using the runway centerline station and the angle at which they intersect.
- d. Indicate all off-site property interests for drainage, clearing, obstruction, control, building removal, and borrow.
- e. Perform a site survey showing existing buildings, lot lines, building lines, and their relation to proposed construction.

5-5.0205 Alignment

It is important that the following information be obtained by field survey:

- a. Centerline alignment points and stationing of existing or proposed runways, existing or proposed taxiways, existing or proposed service roads, and existing or proposed highways.
- b. Station equations at intersections of runway centerlines.
- c. Intersection angles between runway centerlines.
- d. Station equations and intersection angles of runway and taxiway centerlines.

- e. Station equation and intersection angle where the runway centerline, extended, intersects the centerlines of proposed or existing highways, railroads, service roads, and streets.
- f. Identify runways by magnetic numerical designations. The magnetic azimuth is rounded to nearest 10° , and then the last digit is dropped (i.e., 040° is runway 04; 310° is runway 31).
- g. Magnetic declination, magnetic north, and true (meridian) north.
- h. Clearance distances:
 - 1. Runway centerline to taxiway centerline.
 - 2. Runway centerline to buildings.
 - 3. Runway centerline to parallel runway.
 - 4. Runway centerline to property line.
 - 5. Runway and taxiway centerline to aircraft parking.
 - 6. Taxiway centerline to taxiway centerline.
 - 7. Runway centerline to highway centerline, where runway is nearly parallel to the highway.

5-5.0206 Profiles

The following profiles are required for airport surveys:

- a. Existing ground along runway centerline. Extend the profile well beyond the end of the runway to indicate problems. Show station and elevation of end of pavement and all breaks in grade.
- b. Centerline of taxiways, including elevations at runway intersections.
- c. Service roads, railroads, and highways that are in the approach area of all runways. Take a profile along the high side of superelevated curves.
- d. Ground line over sub-surface drainage.
- e. Profile or cross-section aprons as required.

5-5.0207 Contour Map

The amount of survey data necessary for an airport survey will vary greatly with each survey. New airport construction will require adequate survey data to prepare a contour map. Typical sections may be required for runways and taxiways, drainage ditches, parking aprons, highways, streets, roads, parking lot, and over centerline culverts.

5-5.0208 Topography

In addition to regular topography, the following items should be incorporated into the airport survey, and the highest elevation of many of these must be shown:

- a. Runway length and width.
- b. Runway surface - sod, bituminous, or concrete.
- c. Taxiway length, width, and type of surface.
- d. Building aprons.
- e. Jet blast pads.

- f. Runway overrun and shoulders.
- g. Building dimensions and height, including buildings in runway approach areas.
- h. Navigation aids.
- i. Fences - type and height.
- j. Segmented circle and wind tee or cone - give elevations.
- k. Fueling facilities - avgas and jet fuel.
- l. Airport beacon - give elevation.
- m. Tie-down areas and location of tie-down anchors.
- n. Control tower and elevation.
- o. Displaced thresholds.
- p. Arresting barriers - type and size.
- q. Terminal area.
- r. Prominent topographic features: trees (show height), streams, ponds, rock outcroppings, ditches, railroads, roads, power lines (show height), towers (show height), and buildings (show height). Include all such features in the runway approaches.
- s. Runway and taxiway lights.
- t. Identify the runway approach clear zones.
- u. Approach lights.
- v. Airport visual aids and weather facilities.

5-5.0209 *Drainage*

Identify the following by type and size. Show direction of flow, slopes, stationing of critical points and structures, and invert elevations.

- a. Storm drains.
- b. Ditches.
- c. Subsurface drainage.
- d. Headwalls.
- e. Culverts.
- f. Manholes, catch basins, inlets.
- g. Special structures, such as flumes, berms, and riprap.
- h. Rivers, streams, and other natural watercourses.

5-5.03 BRIDGES

Location surveys may include bridge surveys at railway or highway grade separations, river and stream crossings, and bridge replacement sites. All of the following data shall be obtained by the survey crew in the field, so that this data can be placed on Bridge Survey Sheets or in survey notes for evaluation by the bridge design and hydraulic engineers. Section 5-5.0309 to Section 5-5.0318 are specifically for the hydraulics engineer, who may request other data that could affect the type and design of the structure.

5-5.0301 *Alignment*

Recover or reestablish the alignment points controlling the centerline of the existing or proposed roadway.

As with any alignment, these points should be related to a control network (County Coordinate System) by traversing or GPS methods. Temporary alignment points should be placed on each side of the bridge site to perpetuate the alignment for construction staking. Make at least three ties to each alignment point. Establish stationing at the center and each end of the bridge, and record for future reference.

In cases where bridge structures are more than 500 ft long, it is advantageous to establish a horizontal control net around the outside of the construction limits. This should be done at the same time the bridge survey or the photo control is being done. An accurate control net can be established with coordinates, such that the working points and other necessary points can be set or measured from the individual control points. The shape of the control net should be close to a quadrilateral whenever possible, but is largely dependent upon the terrain. Control points for bridge construction should have high intervisibility between the control points and the bridge and should be located as high as possible to permit sighting down upon the super-structure. The least-squares method should be used for the adjustment of the control net and ties, and computations should be made to tie the bridge alignment, working points, and R/W into the coordinate system. The control net should have a standard deviation of less than 0.05 ft.

5-5.0302 *Vertical Control*

Record the location, elevation, and description of the bench marks (BM) used in the survey (see Section 2-3.0405 through Section 2-3.0407). All elevations must be referenced to a bench mark tied to the North American Vertical Datum of 1988 (NAVD 88) unless otherwise specified. Set at least one bench mark near the bridge site for construction staking, and more if necessary, especially at river crossings or areas of extreme relief. Make a third-order level run between two benchmarks when setting elevations on the bench marks at the bridge.

5-5.0303 *Roadway Profiles*

Profile the roadway centerline and at predetermined distances left and right of roadway centerline to a minimum of 600 ft each direction from the proposed bridge site. Take additional profiles at 50 ft from centerline or at some other distance if required by proposed bridge widening. Take a profile on centerline under the bridge between the abutments. In place and proposed roadway profile will include the sag point (if applicable) and extend to at least the elevation of the extreme high water. At a grade separation of two roadways, the profile of both the upper and lower roadway shall be taken a minimum of 600 ft in each direction from the center of the bridge. Show the type of surfacing on all roadways.

5-5.0304 *Roadway Cross-Sections*

Take roadway cross-sections to a minimum of 600 ft each direction from the proposed bridge site, and farther if high water conditions existed beyond the 600 ft point. For bridge replacement surveys, extend the cross-sections left and right of centerline a distance sufficient to cover flattening of side slopes and the increased height of the roadway and new bridge approach fill.

Take several cross-sections at the abutment end of the bridge approach fill to show the design engineer the shape of the fill and the side and end slopes.

At grade separations between railroads and roadways, profile the top of all rails 600 ft each side of the bridge centerline. The side of each rail section is embossed with the term "rail weight" by the rail manufacturer. Show the height and "weight" of the rails.

Profile the grade of any adjacent railroad or roadway, showing elevation of low steel, or the lowest structural member of existing bridges, and if within 300 ft of the proposed bridge, take a cross-section of the stream bed under the centerline of the in-place structure.

5-5.0305 *Intersection Angles*

Determine the intersection angles of all proposed highway and railroad crossings. At locations of a double railroad track, where the tracks are not parallel, show the intersection angle of both tracks. Where multiple tracks are involved, such as yard leads, etc., and the intersection angle is not the same as the main track, show all intersection angles.

5-5.0306 *Description of Inplace Bridge*

Specify the bridge number, type of structure, number and length of spans, width of roadway between curbs, and total bridge length. When there is a possibility of incorporating any portion of the in place bridge into the new construction, show the above information, with a sketch showing the location of the in-place bridge with respect to the new centerline, and tie in all pertinent structural dimensions.

State the age of the in place bridge and any modifications to the bridge. Note the low steel elevation, waterway opening size, and guardrail attached to the bridge railing. Note any utilities, such as gas mains and telephone cables, attached to or adjacent to the bridge. Obtain the ownership information of all adjacent utilities. Take photographs of the in place bridge and submit the photos with the bridge sheets to the bridge design unit and hydraulics engineers.

5-5.0307 *Topography*

Collect topographic features left and right of the roadway to a minimum of 600 ft each direction from the bridge site and 50 ft upstream and downstream from the bridge. Utilities, curb and gutter, tile lines, county drainage ditches, intersecting streams and islands, old piers, and other fixed objects must be included in the topography.

5-5.0308 *Building Elevations*

Any building(s) near the bridge should be noted. Both the foundation elevation and the lowest floor elevation of the building(s) should be noted in the bridge survey sheet.

5-5.0309 *Adjacent Bridges*

If adjacent railroad or highway bridges are within 300 ft of the proposed roadway centerline, tie in the ends of the bridges. Length of spans, bridge number, low steel elevation, and the location of substructure units shall be shown.

5-5.0310 *General Data for Hydraulic Engineer*

It is important to the Hydraulic Engineer to have the location, type, age and total waterway opening of the hydraulic structure itself and those hydraulic structures located both upstream and downstream of the site.

5-5.0311 *Normal High Water Elevation*

“Normal High Water Elevation” shall be determined. For purposes of bridge and culvert surveys the “Normal High Water Elevation” is defined as the water stain line etched on the side of a culvert barrel or bridge pier/abutment.

5-5.0312 *Determination of Extreme (Highest) High Water*

Document the source of the extreme water elevation in the vicinity of the bridge or culvert. The source could be a long time local resident, maintenance personnel, government agency, etc. Document the location of the highest water elevation - whether it was {at the} upstream or downstream of a bridge or culvert. *Ideally, it would be preferable to have both upstream and downstream high water elevations.*

Questions to ask about the extreme high water:

- a. The date of the extreme high water event.
- b. The duration of the extreme high water.
- c. Did the water overtop the road, and if so, how deep?
- d. Were any building(s) flooded, and if so, to what depth?
- e. Were any fields flooded?
- f. Was the water higher on the upstream side of the road, and if so, by how much?
- g. Was there a pile-up of ice and debris?

Trees with hanging debris are usually good for determining extreme high water for recent floods.

5-5.0313 *Water Surface and Stream Bed Profiles for Bridges and Culverts*

Take elevations of both the channel bottom and water surface *elevations at the time of survey* every 100 feet for distance of 1000 feet both upstream and downstream of the bridge/culvert. Use 100-foot intervals except where falls, dams, rapids, etc. exist. In these locations, contact Central Office Hydraulics for guidance.

5-5.0314 Stream Cross-Sections for Bridges

Seven cross-sections are typically required to correctly model the bridge hydraulics. Figure 5-5.0314 at the end of this chapter shows the location of these cross-sections. Note: If a DTM exists of the area, it may serve in place of the cross sections described below.

Cross-section 1 is typically taken **four bridge lengths** downstream of the existing bridge. Thus, if the bridge is 100 feet long; cross-section 1 will be approximately four hundred feet downstream of the roadway toe of slope.

Cross-section 2 is typically taken **one bridge length** downstream of the existing bridge. Thus, if the bridge is 100 feet long; cross-section 2 will be approximately one hundred feet downstream of the roadway toe of slope.

Cross-section 3 is typically taken just beyond the toe of slope on the **downstream** side of the bridge.

Cross-section 4 is taken at the downstream face of the bridge.

Cross-section 5 is taken at the upstream face of the bridge.

Cross-section 6 is typically taken just beyond the toe of slope on the **upstream** side of the bridge.

Cross-section 7 is typically taken **one bridge length** upstream of the existing bridge. Thus, if the bridge is 100 feet long; cross-section 7 will be approximately one hundred feet upstream of the roadway toe of slope.

Note: If a DTM covers the area of the cross-sections then an underwater tin could be merged with the above ground tin to allow the designer to cut the respective cross-sections.

All cross-sections should extend to at **least three feet** above the “Extreme high water” elevation. All cross-sections should be taken perpendicular to the contours of the channel and overbanks. It is common for cross-sections to be crooked. All cross-sections should include the natural channel.

Additional cross-sections may be required at channel constrictions, such as falls, rapids and dams. Contact Central Office Hydraulics for guidance in these areas.

Show the location of each cross-section by station on the stream profile and show the location on the Bridge Survey layout map. Every cross-section and profile should be readily identifiable as to elevation and station. Cross-section elevations must be indicated, even if referred to an assumed datum.

Stream cross-sections should be representative of a typical reach of the natural channel and floodplain. Cross-sections should **not** be taken in roadway ditches.

5-5.0315 Stream Cross-Sections for Culverts

All other data needed for a bridge is the same for a culvert except **culverts typically require only two cross-sections**. One typical cross-section downstream of the culvert should be taken at the narrowest portion of the floodplain *and extended to an elevation at least three feet above the extreme highwater elevation*. The second cross-section should be taken approximately twenty feet upstream of the culvert.

5-5.0316 Photographs

Take pictures of all features pertinent to the structure and the stream. Take pictures of the bridge opening, roadway approaches, abutment slopes, piers, upstream and downstream channel and floodplain and lowest building(s) upstream.

5-5.0317 County and Judicial Ditches

It is very important to re-establish the original county and judicial ditch gradients to assure correct inlet and outlet elevations for highway structures. The flowline of any proposed structure should be at the established ditch grade elevation.

5-5.0318 Flood Insurance Studies

Before going out to the field, check with the District Hydraulics Engineer to determine if there is a Flood Insurance Study that covers the location of the bridge/culvert. If there is a Flood Insurance Study for that area then the required survey information will likely to be reduced. Contact Central Office Hydraulics for guidance in these situations.

5-5.04 COMMUNICATION TOWERS

Communication towers transmit or convey radio frequencies for television, telephone, and radio communication systems. Caution should be used when coming near a tower, since some are hot or alive with electricity. Do not enter onto the tower site before making contact with the manager of the tower to find out what precautions must be taken to avoid injuries and prevent damage to property. Obtain the owner's name, F.C.C. license number, station call letters, type of frequency (A.M., F.M., TV), and the type of signal and wattage transmitted by the tower.

The field survey of the tower site will require general topography above and below ground elevations. Special data to be included in the notes are: tower height, outside dimensions of the tower, size of footings, size and type of guy wire bases, and the type and layout of the buried grounding grid system (usually extensive only for A.M. broadcasting towers).

5-5.05 DRAINAGE

Hydrology is the science of properties and distribution of water on the surface of land. Mn/DOT is most concerned with the amount of water that runs off the land surface and its effect on the design of highway drainage structures.

Drainage survey notes and mapping shall record or show location and elevation (adjusted datum) on ditches, waterways, inlets and outlets of culverts, tile lines, catch basins and manholes, and the continuation of these items beyond the right of way. In addition, classification will be made on all adjacent wetlands, as well as location of drainage areas and structures that carry flow above and below the highway corridor.

5-5.0501 Rural Drainage

- a. When drainage information (profiles, spot elevations, etc.) is included along with field cross-sections, label this data "for drainage only" so it is easily identified.
- b. Measure a concrete culvert with aprons along the flow line from end of apron to end of apron, and indicate in the notes that the length includes aprons. If a concrete culvert has no aprons, measure the barrel length, and indicate in the notes

that aprons were not present. Measure a metal or plastic culvert along the flow line from end of barrel to end of barrel, and indicate in the notes whether aprons should be added to the length. Measure both the span and rise for pipe arch.

- c. Profiles of drainage ditches should be taken in the ditch bottom and on the water surface if present. Take profiles beyond the proposed R/W until positive drainage is established. Locate where the natural waterway or ditch crosses the proposed highway centerline and indicate the skew angle, if any.
- d. Typical cross-sections should be taken upstream and downstream, at right angles to the natural waterway or ditch. The section downstream will aid in the computations of tailwater and the design of the proposed drainage structure. Also, take a cross-section downstream where the flood plain narrows or constricts flow and may affect structure design.
- e. Locate farm sites, feed lots, buildings, etc. within the upstream flood plain, together with elevations (adjusted datum) at the base of foundations and on natural ground.
- f. If drainage tile will be affected by road construction, tie the tile horizontally and vertically, within and beyond the proposed R/W, to provide the designer with the necessary information to perpetuate the tile system.
- g. County and Judicial Ditch Systems - In many instances, an existing public ditch grade may currently be erroneous due to silting or scouring, causing the originally established ditch grade to be altered. To insure correct flow lines and grades for highway design of drainage structure, the following policy will be followed concerning reestablishment of county and judicial ditch grades.
 1. The Surveys Engineer/Surveyor will review drainage ditch records in the County Auditor's office and consult with the engineering authority responsible for the ditch to determine the originally established flowlines for every County and Judicial ditch encountered on the project.
 2. If flowline information cannot be located, the controlling ditch authority should be asked to determine the flow-line elevations. (Note: A request to the ditch authority should not be made before consulting with the Office of the Attorney General.)
 3. Any commitment to elevations and gradients should be obtained in writing. Structures shall then be designed and constructed from the established gradients or flow-line designated by the ditch authority.
- h. High water - For these determinations see Section 5-5.0311 through Section 5-5.0313 in the bridge survey section in this manual.

5-5.0502 *Urban Drainage*

- a. During the research for survey data on inplace sewer systems, contacts will be made with the municipality for layout maps and a review of the system. Additional information may be obtained from abutting property owners and business places along the proposed project location. Record sewer information in the field notes, along with names of persons and phone numbers for future contact.
- b. Survey the drainage system well beyond the normal survey limits to enable the Hydraulics Engineer or designer to establish the capacity of the system. Those systems operating nearly at capacity may require alternate outfall locations to take care of increased flows or increased drainage areas.
- c. A field survey may be required to determine drainage areas.

- d. During the survey a review should be held with the District Hydraulics Engineer to address any concerns or problems that may require additional field data.

5-5.06 PRESERVATION OF HISTORICAL SITES

Public Law 89-665, "Preservation of Historic Sites", provides that these sites shall not be disturbed by any person or agency without proper authorization. To disturb a State site, authorization must be obtained from the Minnesota Historical Society, and National Sites Authorization must be obtained from the National Advisory Council on Historic Preservation.

5-5.0601 Definitions of Sites

- a. Historic Sites - These sites are dated after the movement of non-native populations into the State. These would be categorized as fur trading posts, early military posts, early historic cabins, houses and settlements, early missionary establishments, Indian Reservation establishments, fur trade canoe portages, historic battlegrounds, etc.
- b. Prehistoric Sites - These areas record people's activities before the introduction of non-native populations during the historic period. These would be categorized as campgrounds, burial mounds, caves, cemeteries, etc.
- c. Paleontological Sites - These are sites where the remains of prehistoric animals have been deposited in places such as peat bogs, or they may be the remains of hunting activities of people.

5-5.0602 Mn/DOT Procedure

When objects of historical significance are encountered in the pre-design stage or during construction operations, the Central Office Preliminary Design Engineer will be notified by the District Preliminary Design Engineer at the earliest possible date.

- a. Under Mn/DOT Agreement No. 55699, executed in March 1968, the Commissioner has retained the Minnesota Historical Society to carry out a program to record and preserve all archaeological remains affected by highway projects.
- b. The Central Office Chief Preliminary Design Engineer has been assigned liaison responsibility with the Minnesota Historical Society for this agreement.

5-5.0603 Sources of Existing Information

- a. National Register of Historic Places
- b. Highway Archaeology Annual Reports
- c. Map and Listing Prepared by Mn/DOT and Minnesota Historical Society
- d. The Minnesota Archaeological Site Survey File
- e. Local Museums and Historical Societies
- f. Property Owners

5-5.0604 Minnesota Historical Society Field Study

- a. All programmed highway projects are reviewed by Minnesota Historical Society personnel and the respective districts to locate and make recommendations on archaeological sites that might be involved with highway improvements.
- b. The results of these studies will be reported to the districts in which sites were found, and recommendations will be made concerning them.

5-5.0605 District Site Surveys

- a. The District Surveys Engineer/Surveyor may be asked to make a survey of a historical site by the District Preliminary Design Engineer.
- b. All sites will be identified and limits located on the mapping required for corridor study and design purposes.
- c. Survey crews, through interviews with property owners, may uncover unlisted or new sites. These sites will be reported to the District Preliminary Design Engineer to be forwarded for review and investigation by the Minnesota Historical Society.

5-5.07 NOISE WALLS

The survey required for a noise wall consists of baseline alignment, cross-section, and topography (for additional information see Section 6-3.0213).

5-5.0701 Baseline

The baseline is a random line run as nearly parallel as possible with the proposed wall. This accurate baseline allows the wall computations to be based on coordinates. The coordinate system and coordinate data for the baseline should be determined and computed by the district survey section. No curves should be used in the baseline.

5-5.0702 Cross-Sections

Cross-sections are taken at 100 ft intervals on the baseline and extend outward far enough to allow plotting of in-place slopes, which are needed for post embedment computation and to determine affected drainage pattern. Cross-sections may not be needed in some areas where wall alignment has already been established in the field. A centerline profile of the wall alignment may be accepted.

5-5.0703 Topography

Topography is an essential item in noise wall design and must be complete. Overhead wires and underground utilities are critical, since some postholes may be 20 ft deep and post heights may reach 30 ft. Location of utilities may dictate wall alignment; therefore all utilities within the proximity of the proposed wall must be tied in through field survey. General topography for the base map may be taken from aerial photography or field survey. Include location of poles and elevation of overhead wires.

5-5.0704 Base Map

The base map is made in the district surveys section. It includes the topography, utilities, grid ticks, property lines, PLSS lines, and survey control monuments.

5-5.08 OVERLAYS

Overlay surveys are made to perpetuate in-place alignment, perpetuate PLSS and private property monuments, and provide information to the designer. On those projects where turn lanes will be constructed, see Section 5-5.14.

5-5.0801 Alignment

Alignments that should be recovered and monumented when applicable are the construction and right of way centerlines if they are not in coincidence. In those cases where the construction centerline is not the centerline used for acquisition of property,

it is important, for the protection of the public, to monument or determine the coordinates the right of way centerline. These coordinates must be related to a known coordinate system, preferably the Minnesota County Coordinate System (1996 HARN).

Iron or magnetic monuments should be used to perpetuate alignment points, where applicable, since they are easily detected with a metal locator. Coordinates to the alignment points, found in-place or computed must be related to a control network preferably the county coordinate system and ties to the points should also be made and recorded. The method of perpetuating brass plugs found in concrete being overlaid is an individual problem to be solved and documented at the time of the survey.

5-5.0802 Perpetuation of Public Land Survey System Corners

It is important, for protection of public rights, that all PLSS land corner monuments within the paved roadway be located, brought to the surface, and monumented and that Certificates of Location be filed (see Section 3-3). Future use of the perpetuated corners would require only minimal excavation, with little damage to the road surface. Contact the County Surveyor before moving any monument. The County Surveyor may require a specific type or size of monument be placed. The surveyor may desire to have their office reset and record the placement of the monument.

5-5.0803 Information for Designer

- a. Typical cross-sections are taken at random locations, as required, to show existing mat and shoulder widths. This information can be acquired from aerial mapping if DTMs were produced as part of the final product.
- b. A number of profiles and/or cross-sections may be needed by the designer for quantity computation at such location as: sags, culvert replacements, bridge approaches, railroad crossings, distorted curves, and frost heave removals. Review with the designer to determine what data is needed. Also, this information can be acquired from aerial mapping if DTMs were produced as part of the final product.
- c. Note areas of right of way encroachment.
- d. Tie in all utilities that will be affected, such as manholes, catch basins, and valves in urban sections.

5-5.09 PIPELINES

Four data items should be recorded when gathering information on pipelines for the designer: Ownership, Product Being Transported, Pipeline Material, and Location.

5-5.0901 Ownership

All pipelines are marked in the field with identifying signs, generally at major road crossings, water crossings, and railroad crossings. Permits are on file in the District Permits Unit that will show the ownership at the time of pipeline construction.

There are two offices in St. Paul that can also be of help in securing information:

- a. The Department of Public Safety, Office of Pipeline Safety can provide information, not only on existing, but also on planned and under-construction pipelines.
- b. The Mn/DOT Utilities Unit has an up-to-date list of the operating companies, along with the name and phone number of the contact person.

5-5.0902 Product Being Transported

There are three general classifications of pipelines: oil, commodity, and gas.

- a. Oil - These pipelines transport only crude oils from the oil field to the refinery.
- b. Commodity - These pipelines are common carriers and move various petroleum products, liquefied petroleum gas, liquid fertilizers, and anhydrous ammonia.
- c. Gas - These pipelines transport natural gas under high pressure from gas fields to distributors.

5-5.0903 Pipeline Material

Gas transmission pipe is called line pipe and is high-pressure pipe. For example, the Great Lakes Gas Transmission Co. line has compression or pumping stations 80 miles apart; the transmission pressure at a station inlet may be 3.5 MPa (500 PSI) and at the outlet 6.7 MPa (974 PSI). This high-pressure steel pipe will have a protective coating of asphalt and paper or wax and paper, with an outer coating of cement in wet or swampy areas where buoyancy is a problem. The piping material used in low-pressure distribution is either steel or plastic, plastic pipe generally being limited to three inches and smaller. Liquid petroleum products are transported in steel pipelines. These pipes also have coatings weighted for negative buoyancy and are supported on various types of structures in unstable areas.

5-5.0904 Pipeline Location

After it has been determined what survey information is needed, the pipeline company is contacted. They can provide information on general details of the line and right of way widths in the area being surveyed. If a detailed survey is required, arrangements can be made to meet their locating crew at the site. The pipeline crew will do all location work.

The Mn/DOT survey party will:

- a. Tie in location of pipe at all probe points to the county coordinate system.
- b. Obtain the elevation of top of pipe and the ground elevation at each probe point preferably tied to the NAVD 88 vertical datum.
- c. Record the size and type of pipe.
- d. Record the size and tie in the ends of casing pipe and vents.

5-5.10 PITS

Pit surveys should be made under the guidance of the District Land Surveyor or/ Surveys Engineer. Requests should be coordinated with the District Materials/Soils Engineer, so that existing pit layout sheets and other pertinent information may be obtained prior to the survey. The following applies to all pit surveys:

- a. Ownership - If the pit is well within property line boundaries, a land survey is not needed. If a boundary survey is required, it must be made under the direction of a registered land surveyor.
- b. Control - All pits should have permanent vertical and horizontal control monuments, because some pits are used for many years, and subsequent surveys must be tied to the original datum. Vertical control bench marks should be tied to the North American Vertical Datum of 1988 (NAVD 88) unless otherwise specified. Two bench marks should be established for each pit. Horizontal control monuments

should be tied to the County Coordinate System (1996 HARN), and PLSS lines and corners when possible.

- c. Data collection - Collect sufficient topographic data to produce the required mapping and volume computations. In the past, transit-stadia pit surveys were run with typical tolerances of 5 ft horizontally and 0.5 ft vertically. With today's electronic total stations tolerances should be significantly closer. If DTMs are available from the aerial mapping, these also may be used for computations.
- d. Data - The data collected should be plotted in an electronic file. A surveyor's sketch may be helpful. All control points should be tied out and shown on the electronic pit layout sheet. The Central Office Aggregate Unit will complete the drafting of all pit sheets and will utilize the District's layouts whenever possible to eliminate duplication of effort and to facilitate rapid completion of the final product.
- e. Review - A land surveyor should review all completed electronic pit layout sheets prior to insertion in the plans to insure completeness relating to boundary lines. These electronic files will be distributed to the districts immediately after final drafting.

5-5.1001 New Pits

Include the following:

- a. Locations and elevations of all borings.
- b. All necessary control monuments. See Section 5-5.10, "Control". GPS can be used as an alternative to ground control.
- c. Sufficient shots to produce the required mapping and volume computations.
- d. Fence lines and property lines.
- e. Locations of all roads, including ties to road stationing.
- f. Structures.
- g. Lakes and streams.
- h. Limits (perimeter) of any existing pits, including the location and elevation of sufficient bottom shots.
- i. Limits and location of wooded areas, clearings, swamps, rock outcrops, etc.
- j. Orientation with respect to north. Indicate basis.
- k. Location of pipelines and power lines crossing pit property.

5-5.1002 New Borings in Existing Pits

- a. Use original control and / or monuments as shown on pit layout sheets and relocate and retie when necessary.
- b. Tie new survey data to original control.
- c. Update data consistent with requirements for "New Pits" reflecting changes on original electronic layout sheet and expansion into new areas.

5-5.1003 Condition Survey of Existing Pits

- a. Use original control and / or monuments as shown on pit layout sheet and relocate and retie when necessary.
- b. Tie new survey data to original control.
- c. Survey the limits of the excavation by taking shots around the perimeter. If an existing pit is shown on the electronic pit layout sheet, it is only necessary to survey any expansion.
- d. Take enough shots to indicate location and the elevation of the pit bottom.
- e. Survey the perimeter, elevation, and depth of any standing water in the pit that might indicate the water table.

5-5.11 RAILROAD

Location surveys may include railroad surveys where a highway is constructed parallel or adjacent to a railroad or where a highway and a railroad intersect. The base maps, location profiles and electronic bridge sheets shall be submitted upon completion of the work (Note: see Section 5-5.1109 for glossary of railroad terms).

5-5.1101 Record Research

Prior to any field work the District Surveys Unit shall research the Mn/DOT engineering records, which will include any of the following data:

- a. Right of way maps and plats.
- b. Previous base maps and location survey notes.
- c. As-built plans and the construction notes.
- d. Horizontal and vertical control mark data.

The District Surveyor/Surveys Engineer shall contact the railroad company involved to explain the proposed project, obtain permission to enter onto their property, secure their train schedules, secure their safety regulations, discuss their design criteria and secure their engineering records. The railroad company engineering records should include the following items:

- a. Railroad right of way and track maps.
- b. Railroad profile and station maps.
- c. Survey notes.
- d. Construction engineering data: i.e., types and numbers of frogs and switches.

5-5.1102 Field Procedure

All of the following information for railroad surveys shall be obtained by the survey crew in the field so the District Surveys Unit can prepare the base maps, location profiles and electronic bridge sheets required. The information shall be distributed to the pre-design, design, bridge design and soils engineers for their evaluation and use in preparing the layouts, plans, and exhibits used in the railroad negotiations.

5-5.1103 *Alignment*

Recover or reestablish the alignment points controlling the centerline of the existing or proposed highway and the centerline of the railroad. Relate all alignment points to a coordinate network (County Coordinate System). Make at least three reference ties to each alignment point.

Highway centerline stationing must be related to the existing mapping. The stationing of all track crossings shall be obtained in the field and each track shall be described by its use, i.e., a main track, double track, siding, yard track, switching lead, yard running track, industry track, or special use track. In the case of a double track the direction of traffic for each track shall be noted.

Railroad stationing must be related to the existing railroad mapping. The stationing should be established from a head block (point of switch) or from the 2-inch point of frog (see Section 5-5.1109, Glossary of Railroad Terms). The points of switch, switch leads, points of frog and frog numbers should be located, measured and recorded. The railroad stationing of all existing and proposed highway crossings shall be obtained. To help reestablish the railroad stationing, the stationing shown on the railroad map for station points, entrance crossings and culvert locations can be used. The railroad stationing direction can be obtained from the railroad mapping and the direction will usually correspond to the direction of increasing milepost numbers.

5-5.1104 *Vertical Control*

Record the location, elevation and description of the bench marks used in the survey. A recovery note form (see Section 2-3.0405) must be filled out for all Mn/DOT, GS, NGS or USC & GS bench marks located. All elevations must be referenced to a bench mark tied to the North American Vertical Datum of 1988 (NAVD 88). At least one bench mark must be set near the construction site and more if necessary, especially where grade separations and shooflies are involved. Make a 3rd order level run between two bench marks when setting elevations on the additional bench marks.

5-5.1105 *Intersection Angles*

Determine the intersection angles of all proposed highway and railroad crossings. At intersections of railroad double tracks, where the tracks are not parallel, show the intersection angle of each track. Where multiple tracks are involved, such as yard leads, etc., and the intersection angle is not the same as the main track, show all intersection angles.

5-5.1106 *Profiles and Cross-Sections*

Where a highway is adjacent and/or parallel with a railroad, take cross-sections through the area that involves longitudinal encroachments within the railroad right of way. The cross-sections must include both the highway and railroad grades. The profiles of the railroad track shall be taken simultaneously with the cross-sections, taking elevations at the top of tie and top of rail. Some of the information for the profiles and cross sections can be acquired from the DTMs produced from the aerial mapping. The side of each rail section is embossed with the term "rail weight" by the rail manufacturer. Show the height and "weight" of the rails.

If a highway and a railroad cross at grade, profile the existing railroad track for a minimum distance of 500 ft each side of the crossing on either top of ties or top of rail, noting which feature was profiled. Also note the rail size information and tie plate thickness. Take cross-sections of the existing or proposed highway for a minimum distance of 500 ft each side of the track or tracks. The profile of the existing or proposed highway shall be taken simultaneously with the cross-sections. Some of the information for the profiles and cross sections can be acquired from the DTMs produced from the aerial mapping.

At a highway and railroad grade separation, two conditions are possible - the highway underpass or the highway overpass. In the case of a highway passing under a railroad, a shoofly is usually required to carry railroad traffic around the site of the underpass structure. Cross-sections are required along the railroad centerline for a distance of 1000 ft each side of the proposed structure. Take the sections to a distance of 150 ft from the centerline of the railroad track on both sides of the track. The cross-sections may be shortened on the side opposite the shoofly if its location has been determined. Take the cross-sections at right angles to the track and include the top of tie, toe of ballast, shoulder or railroad subgrade slope, ditches, etc. If a shoofly is not planned, take the cross-sections to a distance of 600 ft each side of the proposed structure.

Take the profile of the top of rail or top of tie at predetermined distance right and left of the railroad centerline simultaneously with the cross-sections for the distances required, i.e., 600 or 1000 ft each side of the crossing. Show the height and weight of rail. A shoofly grade will usually follow the main track grade, and the ground line profile for the shoofly can be obtained from the cross-sections. Take a profile of the existing or proposed highway centerline for 600 ft each side of the main track crossing and include a sectional view of the proposed underpass location.

In the case of a highway overpass, take cross-sections to a distance of 600 ft each side of the crossing at right angles to the highway centerline. The cross-sections should be wide enough for the highway design and shall include a profile at predetermined distance right and left of each proposed overpass structure. The profile should include a longitudinal view of the proposed overpass. Take a profile of the top of each rail for 600 ft each side of the proposed overpass structure and show the rail size information.

5-5.1107 Topography

Take the regular topography left and right of the highway centerline 600 ft each side of the crossing. The topography shall show the buildings, tracks, culverts, signals, fences, curb and gutter, sidewalks, switches, frogs, derails, signs, bridges, ditches, utilities, etc. Include in the topography the name of the owner and the address of all utilities, along with the name of the person and the date any underground utilities were located for the survey.

5-5.1108 Drainage

Identify the following drainage items by type and size. Show direction of flow, slopes, stationing of critical points and structures, and invert elevations.

- a. Storm drains.
- b. Headwalls.
- c. Culverts.
- d. Manholes, catch basins, inlets.
- e. Ditches.

- f. Subsurface drainage.
- g. Special structures, such as flumes, arms, and riprap.
- h. Rivers, streams, lakes, and other natural water courses.

5-5.1109 *Glossary of Railroad Terms*

(Note: Historical railroad definitions are stated in their original English units.)

BALLAST - The crushed rock or gravel placed between and below the ties of a railroad.

TIES - The parallel cross beams to which the rails of a railroad are fastened.

SWITCH - A movable section of railroad track used in transferring a train from one set of tracks to another.

POINT OF SWITCH - The end of the movable track used in transferring a train from one set of tracks to another.

HEAD BLOCK - Same as “point of switch”.

FROG - A device on the railroad track for keeping the cars on the proper rails at intersections or switches.

FROG NUMBER - Represents the angle or rate of spread of the frog rails. The “number” is obtained by measuring in feet the distance between “the point of frog” and the location where the “gauge” side of the frog rails have widened or spread to one foot apart.

POINT OF FROG - The point where the wheel flanges crosses one of the rails.

GAUGE - The distance between the rail heads measured at right angles to the heads and 5/8in below the top of the rail.

STANDARD GAUGE - 4' 8-1/2" on tangents. Increased (very slightly) on curves according to the degree of curve.

SWITCH LEAD - The distance from the point of switch to the 2-inch point of frog.

AUTOMATIC SWITCH - Switches that are actuated from the operating control center. Other switches are operated manually.

SHOOFLY - A temporary track required to carry railroad traffic around the site of the proposed structure during its construction.

LADDER TRACK - A track used to connect a group of parallel tracks.

5-5.12 SIGNAL - TRAFFIC

A signal survey is basically a utility survey and is usually needed where traffic signals are to be installed or upgraded in an urban area.

The District Traffic Engineer will initiate the survey request and list the type of information needed

5-5.1201 Data Required

- a. Topography and ownership of in-place underground utilities.
- b. If the signal is to be an overhead type, elevations of the centerline of the traveled roadway opposite the intended signal base location are needed.
- c. A partial cross-section may be needed instead of the single elevation if the location of the signal base has a steep slope or large vertical difference from the centerline. This cross-section should begin at the centerline of the traveled lane and pass through the location of the intended signal base. These elevations may be relative difference elevations and need not be tied to sea level datum unless convenient. This cross-section will be used to determine base and signal height so minimum lane clearance specifications can be met.

5-5.13 TUNNEL

In some metropolitan areas, storm sewers will be built using tunnel construction rather than open trench because of existing building and drainage patterns.

After it has been determined that tunnel techniques will be used for construction of the storm drain, a control survey will be initiated on the surface along the route of the proposed tunnel. Control points and alignment points shall be referenced to the County Coordinate System (1996 Harn) where possible.

A control net, adjusted by least squares, is the most desirable, but a compass rule adjusted traverse may be used. If least squares is used, control point standard deviations may not exceed 0.1 ft. If compass rule is used, then the ratio of precision should not be less than 1:20,000.

Control points should be so spaced as to allow all necessary tunnel alignment points, alignment and utility holes, and shafts to be seen or staked. Proper electronic survey systems shall be used to provide the required survey accuracy.

A planimetric base map shall be made employing either aerial or field survey techniques.

A land survey will be made if underground easements are required. In urban areas, block corners and street centerlines are usually tied to the coordinate system.

All utilities, existing wells, buildings, underground structures, piezometers, and pilings within 100 ft shall be tied in and placed onto the base map. This distance may vary depending on soil conditions, water table depth and predicted soil stability problems.

Elevations of existing underground tunnels in the proposed tunnel area must be determined, as clearances are critical.

Vertical Control should be run before construction and should be placed at least 100 ft from the centerlines or as required to maintain stable monumentation. Elevation points should be established on adjoining buildings and structures and should be leveled through on a regular basis to record any elevation change. Second order procedures should be used. Refer to Chapter 2, Geodetic Surveys.

A survey report should be made to identify specific problems and make suggestions regarding the survey.

Specifications concerning line, grades, and alignment holes are usually placed in the proposal, and these should be written or reviewed by the District Surveyor/Surveys Engineer before the letting.

Structural crack surveys are usually done by consultants and are done between bid letting and construction.

For survey activities during tunnel construction see Chapter 6, Construction Surveys.

5-5.14 TURN LANES

Data required for a turn lane survey is variable. Generally the Pre-Design (Design) Engineer and District Surveyor/Surveys Engineer will inspect the project location to determine what survey data is needed in addition to the following.

5-5.1401 Vertical Control

When possible use the North American Vertical Datum of 1988 (NAVD 88). Otherwise, use another agreed upon datum.

5-5.1402 Topography

A complete topographic survey is required for each turn lane location, which should include:

- a. Location and condition of centerline and entrance or road culverts
- b. Both transverse and longitudinal utility location and ownerships
- c. All obstacles within the clear zone
- d. Local common road names
- e. Signs that will have to be moved
- f. Drainage conditions.

5-5.1403 Cross-Sections

The number of cross-sections needed is variable and can be related to the method of measurement the designer will use for payment items and to the topography of the area. For example, in a flat rural area where the borrow items are to be plan quantity, two cross-sections would be enough to compute quantities; whereas in a built up urban area, high fill area, or drainage channel area, a full set of cross-sections will be needed. Review the Mn/DOT Road Design Manual for more detailed data on extent of turn lanes.

5-5.15 UTILITIES

A survey shall include the location and elevations as needed of all utilities in the vicinity of any proposed Mn/DOT construction project. The Attorney General's Office has ruled that when a plan does not show an underground installation, it implies the required construction can be made without conflict and any subsequent damages are subject to claim. To avoid construction damages, delays, and claims, it is imperative that all in-place utility facilities are identified, located, and shown on the construction plan and that elevations are determined as needed. Utility surveys can be performed by the District Surveys Office or by consultants qualified to complete these types of surveys. Reference to the Mn/DOT Utility Manual may provide guidance.

5-5.1501 Office Research

Prior to any field work, the District Surveys Unit shall research the Mn/DOT utility permit file for all utilities placed within Mn/DOT's right of way by permit.

The District Surveys Office shall contact the utility companies involved to explain the project, obtain their safety regulations, and obtain the engineering records that may include the following items:

- a. Maps of utility location
- b. Profiles of utility
- c. Survey notes
- d. Construction and engineering plans

5-5.1502 Municipally Owned Utilities

The Directory of Minnesota Municipal Officials is published yearly and includes the names and addresses of City Engineers, Utility Superintendents, Public Works Directors, Airport Managers, Water Superintendents, etc. for each city. Each district library has this directory. The District Surveyor/Surveys Engineer should refer to the directory to contact the proper municipal official. Municipally owned utilities may include any of the following systems:

- a. Water distribution
- b. Steam distribution
- c. Gas distribution
- d. Electric power distribution
- e. Sanitary sewer
- f. Storm water sewer
- g. Other services

5-5.1503 Privately Owned Utilities

The Minnesota Utility Commission has mapping showing the operating areas of many of the privately owned utilities. District libraries should include this information. The District Surveyor/Surveys Engineer shall make contact with the utility company engineer, and where a possible conflict with construction operations may occur, the utility company should be requested to locate the facility. Privately owned utility companies may include any of the following systems:

- a. Telephone communications
- b. Electric power transmission
- c. Electric power distribution
- d. Radio communications
- e. Crude oil pipeline
- f. Gasoline pipeline
- g. Gas pipeline
- h. Gas distribution
- i. Abandoned lines
- j. Cable TV

5-5.1504 Field Procedures

All of the following information for utility surveys shall be obtained by the district survey crew or consultant /contractor so that the District Surveys Unit can prepare the base maps and location profiles required. The information shall be distributed to the pre-design, design, soil, and utility engineers for their evaluation and use in preparing the layouts, plans, and exhibits used in utility negotiations.

The GOPHER ONE-CALL SYSTEM should be contacted to locate all utility lines within the project. It is necessary to specify whether the particular request is for excavation or planning purposes. Suggest that the utility locators meet with the survey crew at the job location to better communicate Mn/DOT's needs.

5-5.1505 Alignment

The utility facilities shall be tied into the county coordinate system (1996 HARN).

5-5.1506 Vertical Control

Record the location, elevation, and description of the bench mark used in the survey. A recovery note Form (see Section 2-3.0405) must be filled out for all Mn/DOT, NGS or USC & GS bench marks found. All elevations must be referenced to a bench mark tied to North American Vertical Datum of 1988 (NAVD 88) unless otherwise specified. A bench mark should be set in the area of relocation of an underground facility by running a 3rd order level survey between existing bench marks. Refer to Chapter 2, Geodetic Surveys.

5-5.1507 Elevations

Record the elevations of the tops of castings; the inlets, inverts, flow lines, and floors of all manholes; and the flow lines of culverts, sanitary sewers, and storm sewers. Note the depth of any cable, conduit, water line, steam line or underground tunnel where applicable. The elevation of the top of pipe of crude oil and gas transmission or distribution lines must be identified by the utility company in the field. Utility companies do not want Mn/DOT personnel to probe for their pipes. When the elevation of a facility is not obtainable, note the average depth or refer to the plans and profiles supplied by the utility company.

5-5.1508 Topography

Show the size, type of construction, and condition of the utility facility. Show the location of all control and shut-off valves. Locate the sag points of heavy power transmission lines. Obtain the alignment of any crossing installations within the probable right of way. Note the brand names of structures, castings, valves, and other appurtenances when identification is possible. For radio towers the grounding system and ground radial transmission area must be determined early in the survey. On aerial utilities having joint ownership, secure the name of the parent owner. Reference should be made to the Utility Inspection Manuals originally prepared by the Engineering Services Division. Any questions concerning terminology, identification, or unusual circumstances should be referred to the C.O. Utilities Section for assistance.

5-5.1509 Profiles and Cross-Sections

When the utility facility is to be relocated, develop profiles and cross-sections from Aerial mapping DTM files as needed for the determination of any required grade changes and the determination of construction quantities.

If aerial mapping DTM files are not available, field measurements will be necessary to develop the cross section and or profiles needed.

5-6 MAPPING

5-6.01 INTRODUCTION

The graphic representation of the earth's surface features, engineering, and property record data is of great importance to those using such information to obtain a relative perspective of the data being portrayed. Graphics in most cases is the cleanest, most easily understood, and most efficient way to store and display data. Therefore, it is very important for the map compiler, and/or draftsman, to understand the map's purpose and the standards needed to provide the information needed.

Graphics layout often requires an artistic ability in order to produce a clean, compact, informative, yet visually pleasing map. In general, decisions relative to scale and amount of detail to be shown greatly affects the map. Mapping standards exist to guide the selection of scale, pen size, line weights, symbols and lettering size to convey various kinds of information on maps. See Mn/DOT CADD Standards Manual.

Mn/DOT produces many types of maps, plan sheets, perspective drawings and sketches, all of which contain different types of information. Maps may be compiled at different scales, on different media, and in different sequences. The following is a discussion of the information needs, procedures, materials and formats used by Surveying and Mapping offices.

5-6.02 BASE MAP

5-6.0201 *Definition*

A base map is a map showing certain fundamental information, copies of which are used to compile additional data of a specialized nature. It serves as a foundation map from which other maps are made.

The term planimetric is used extensively when dealing with base maps and applies only to maps showing features in the horizontal plane. Within Mn/DOT, the term "base map" is defined as the planimetric map produced in most cases by the Photogrammetric Unit in the Central Office or by the District Survey Unit. This base map is used to show the natural and cultural features that can be seen at the site.

5-6.0202 *General*

The Department develops many types of maps, commonly called "base" maps, from the planimetric map. More specifically, these are specialized or special use maps, such as:

- a. Design Map or Location Map - A district annotated planimetric base map showing the in-place features that affect or are affected by the transportation design. Some designers have the photo laboratory prepare their plan sheet window from this map. In the past, this map has been commonly referred to as the "location map."
- b. Right of Way Map - The R/W limits, parcel numbers, owners, acreages, etc., are added to the design map to make this map.
- c. Work Map - A map prepared in the district by combining the base map, design map and the right of way map.

- d. Utility Map - A map usually prepared in the district by taking a copy of the planimetric map and annotating it in the field or in the office from field notes with the detailed information on all utilities. Information includes, but is not limited to: ownerships, number of wires, buried locations, elevations on underground or overheads where crossed, structure ID numbers, etc. In urban areas this map can be so covered with utility information that no other features can be readily shown.
- e. Topographic Map - When contours and spot elevations are added to a planimetric base map, it becomes a topographic map.
- f. Drainage Map - A topographic map can become a drainage map if the mapping limits cover the entire drainage area and all the drainage information items such as culverts, channels, tiles, catch basins, manholes, elevations, flowlines, directions of flow, etc., are added to the topographic base. In many cases 7-½ minute quadrangle maps or enlarged county maps are used as base maps for producing drainage maps. A drainage map will generally have the areas contributing to each drainage crossing of the roadway outlined and will also show the area of each in units of hectares or square kilometers (acres or square miles). A drainage map may also indicate the slopes of the ground within each drainage area.

See Section 5-6.04 for more information on planning a map.

5-6.0203 *Map Elements*

Maps produced by surveys may consist of single map elements or combinations of several, such as:

- a. Cultural and Natural Features - All items, except brush less than 2.0 in. in diameter as measured at a point 2.0 ft above ground, that can be seen by the eye. This includes such items as walls, houses, streets, bridges, fences, power poles, wells (used and unused) within 20 ft of Mn/DOT right of way, catch basins, and manholes. This should exclude minor detail that is unnecessary or descriptive of larger items.
- b. Utilities - This includes all structures and related items above and below ground that are connected with such things as power, water, sewer (storm and sanitary), natural gas, telephones, communications, pipelines, etc.
- c. Record Boundaries - All record title boundaries, ownerships and Government Land Corners. This includes such things as right of way, access control, easements (slope, scenic, or utility, either above or below ground), private property lines, government landlines, political subdivisions, cemeteries, etc.
- d. Surface elevations expressed as contours and spot elevations.
- e. Alignment of all roadways and railroads constructed or planned.

5-6.03 NATIONAL HIGHWAY MAPPING STANDARDS

The specifications followed in the production of all photogrammetric maps prepared in Mn/DOT are found in the "Reference Guide Outline for Specifications for Aerial Surveys & Mapping by Photogrammetric Methods for Highways as Published by the U.S. Dept. of Transportation, 1968."

The following items are taken from the text and show the accuracy standards maintained in the Photogrammetric Unit:

- a. Coordinate Grid Ticks - The plotted positions of each plane coordinate tick shall not vary by more than one one-hundredth ($1/100$ or 1%) of the mapping scale from the true grid value of each map sheet or roll.
- b. Horizontal Control Points - Each horizontal control point shall be plotted on the map within the coordinate grid in which it should lie within one one-hundredth of the mapping scale of its true position as expressed by the plane coordinate computed for the point.
- c. Planimetric Features - Ninety (90) percent of all planimetric features shown on the map shall be plotted so that their position on the map shall be accurate to within one-fortieth ($1/40$ or 2.5%) of the mapping scale of their true coordinate positions, and no planimetric feature shall be out of true coordinate position by more than one-twentieth ($1/20$ or 5%) of the mapping scale.
- d. Contours - Ninety (90) percent of the elevations determined from solid line contours shown on topographic maps shall have an accuracy with respect to true elevation of one-half the contour interval or better and no contour shall be in error by more than one contour interval. In areas where intermediate contours have had to be omitted because of steepness of slopes, the accuracy requirements apply to the contour interval of intermediate contours. When contours are prepared by photogrammetric methods and densely wooded areas are encountered where heavy brush or tree cover obscures the ground and the contours are shown as dashed lines, the contours shall be plotted as accurately as possible from the stereoscopic model, making full use of spot elevations obtained during ground control surveys as well as spot elevations measured photogrammetrically to supplement the contour elevations.
- e. Spot Elevations - Ninety (90) percent of all spot elevations placed on a contour map shall have an accuracy of at least one-fourth ($1/4$) the contour interval and none shall be in error by more than one-half ($1/2$) the contour interval.

The preceding standards are maintained on the photogrammetric base map but cannot be guaranteed for supplemental data added to the map. The Aerial Survey Project (A.S.P.) date and the photo control report date in the datum statement on the map leader will give the user a clue to the age of the mapping.

5-6.04 GENERAL MAP PLANNING

Mapping to be produced in the districts may begin with a request to the Photogrammetric Unit in the Central Office, and then further developed in the District. Other mapping may be completely prepared in the District.

Map planning should include specific requirements to insure the map will convey the information for which it is being designed. Some items to be considered are:

- a. Scale - When more detail is required in a map, such as in an urban area, it will be better represented by a larger scale.
- b. Type of Material - Most maps will be produced in an electronic format. The reproduction material will be determined by the needs of the user of the information. Mylar is a stable and durable material and its use is preferred where accuracy and dependability are required.

- c. Mapping Limits - Economics should be a concern when determining map limits. However, the limits should cover all of the necessary data to satisfy the map purpose.
- d. Layout - If the Photogrammetric Unit supplies the mapping, note layout preference in the request.
- e. Stationing - When maps show alignment, the stationing will generally increase from west to east and south to north. When requesting mapping from Photogrammetrics or others, note the direction of stationing so that map items and lettering will be properly positioned.

5-6.0401 *Map Leaders*

The following is basic information regarding Map Leaders:

- a. Map Title - Identifies the state project and trunk highway number, map limits and use of the map. The title appears on the inside and at the front end of a roll map or on a title sheet in the electronic file. It defines in addition to the items listed above, the department and map scale.
- b. Map Index - Sometimes called a Key Map. It is placed at the beginning, on the inside, and near the center of the map width. The index is usually a small-scale reproduction of a county or city map and indicates project termini and location, a north arrow and county designation.
- c. Map Datum - This statement indicates the compilation of data by Photogrammetrics or field survey methods. It also furnishes horizontal and vertical control statements as they apply.

5-6.05 TYPES OF MAPS MADE

Several kinds of maps are produced by the District Surveys Units. The following list identifies some of the maps and specifies the contents of each necessary to satisfy its particular use in the design, construction, and right of way process.

5-6.0501 *Planimetric Map*

This is a map that represents only the horizontal position of natural and cultural features. It is usually the first map made and is referred to as the base map. It will be used to develop special use maps.

A planimetric map requested from the Photogrammetric Unit will be developed from aerial photography. Additional copies of this map can be requested for development of special use maps.

When this planimetric map is furnished to the District, it may or may not be complete, depending on when the flight was made and if there were any changes or construction in the area mapped since the date of the flight. If the map is incomplete, it should be completed by field survey methods as outlined in Section 5-4.0102 and Section 5-6.03 on Map Accuracy Standards.

A planimetric map prepared in the District will show the same essential information as shown on the map prepared by the Photogrammetric Unit, but it will be drafted from field survey data.

5-6.0502 *Topographic Map*

The topographic map is the planimetric base map with relief (elevation) shown by the use of contours and spot elevations. This map may be accompanied by a digital terrain model (DTM), if requested.

A request for topographic mapping is made to the Photogrammetric Engineer by the District Design Unit or District Surveys Unit in the same manner as for the planimetric map. Photo control requirements are determined by Photogrammetrics and done in the field by the District Surveys Unit or possibly by the Geodetics Unit.

All topographic mapping prepared for the project generally should be produced by the Photogrammetric Unit from aerial photography. Topographic maps for small jobs or sites may be produced by ground survey methods in the District Surveys Unit.

The topographic map produced by the Photogrammetric Unit is usually sent to the District Surveys Unit to be checked and annotated before going to the user.

Topographic maps are used mainly in the preliminary and final design sections and by the Hydraulics Units. Some detail design squads in the department use this topographic map or a DTM to compute earthwork.

5-6.0503 *Design Map*

The Design (Location) Map is produced by Surveys for use in final design. It is compiled to mapping standards and consists of the following mapping elements:

- a. Visible planimetric features.
- b. Utilities.
- c. Alignments of inplace roadways and survey reference lines.
- d. Land ties at section line crossings and record boundaries.

The information shall be compiled at the requested scale according to the steps as outlined in Section 5-6.04, General Map Planning.

A copy of the map can be made after the visible topography and alignment have been placed on the map and before utilities record property boundaries are placed onto the map, which will facilitate the production of plan sheets, a utility map, or the R/W map if needed.

5-6.0504 *Utility Map*

The utility map is an essential map produced for both the Final Design Unit and the Utilities Unit. It is compiled to mapping standards at the requested scale. A coordinate grid system should be used in all urban jobs and also on rural jobs where available.

This utility map, besides showing all utilities, may show alignments of inplace or proposed roadways and visible planimetric features. In urban areas of high-density cultural features, no visible planimetric features other than utilities shall be shown.

5-6.0505 *Alignment Map*

The alignment map is not an essential map. It is usually made by the District Surveys Unit in response to a specific request and should be produced to national mapping standards at the requested scale. This map is overlaid on the planimetric base and usually shows only cultural and natural features and alignments of roadways and railroads.

An alignment map can be used for the production of geometric layouts or to clarify design alignment in very cluttered, complicated, urban, or other interchange areas. On interchange alignment maps showing many mainlines, ramps, and streets with large numbers of curves, identifying these curves by using numbers or letters and consolidated tabulations of the respective curve data is effective. See Section 5-6.04 on General Map Planning for the general rules to follow when establishing new stationing.

5-6.0506 *Drainage*

The responsibility for preparing drainage mapping varies with each District, but it can involve both the District Surveys and Hydraulics Units. The District Surveys Engineer/Land Surveyor and District Hydraulic Engineer should review the needs together to provide suitable mapping.

The data received from field surveys and field inspection will supplement aerial photography in showing drainage areas and their characteristics: high water data, elevations, and locations of streams, ditches, and structures that may have an effect on the design of the drainage structures within a project.

Drainage mapping may be produced in the District, or requests for this service may be made through the District Surveys Engineer/Land Surveyor to the Photogrammetric Unit in the Central Office. For more detailed information concerning drainage mapping, see Mn/DOT's Drainage Manual.

The type and scale of a drainage map depends on the size of the drainage areas. A large drainage area may show up better on a county map, while a smaller area could be better shown on a USGS quad map. Both of these maps are available in the District.

Each District has been furnished County Watershed Inventory Maps, with the drainage areas outlined by the Soil Conservation Service. Contact prints from aerial photography are available from the Photogrammetric Unit. These two sources are useful in determining how to develop drainage mapping.

5-6.0507 *Staff Approved Layout*

The staff approved layout is not an essential map for every project. The need for this map is originated in the District by the Pre-Design Engineer, Project Manager, or Design Engineer. The map is most often used in securing internal approval of complicated geometrics. In a large district, it is a good vehicle for transmitting direction on a project between the preliminary and final design units. It can be useful for maintaining quality design control and for presenting various concepts to the public during the project development stage.

This map is not used strictly for obtaining staff approval of the geometric layout, but also may be used for approval of other important concepts, such as stage construction, future changes, or traffic control.

This map is usually prepared on the most up-to-date planimetric base map or on aerial photo mosaics, but topographic maps, orthophoto maps, R/W maps, or old plan sheets have been used on occasion. It is desirable that this map be overlaid on the planimetric base, because the base map is prepared to national mapping standards. Prints can be made for circulation to those involved in the approval process.

5-6.0508 Record Boundaries

The following maps in this category deal with land ownership and property rights:

- a. Property - A property map shows all property boundaries of record and their dimensions within the mapping area. It is produced to mapping standards and can be used as a base map for ownership, right of way, title, or location mapping.
- b. Ownership Map - An ownership map is usually produced by Pre-Design for use in a geometric layout to study the effects of highway design on property ingress and egress, severance, building encroachment, etc. It is made for graphic use only and does not have to meet mapping standards, therefore scaling should not be done from this map.

The map shows record boundaries as derived from half-section maps, auditor's records, township plats, etc. The names of the property owners are placed on the map according to the record. In the case of lots in a subdivision, the map may tabulate the owners in a box to save space. The alignment of the proposed roadway may also be placed on the map if requested by the user.

- c. Official Map - An official map is defined in Minnesota Statutes 394.22 Subdivision 12 and 394.361. The purpose of this map is to restrict and control development in an area where streets or highways are being planned for a future date. This control is exercised by the county planning and zoning commissions. (While Mn/DOT may perform the actual technical work to create such a map, such work is done at the request of or to assist the county. Within the context of ownership, Mn/DOT does not produce Official Maps.)

The official map is produced from a planimetric map showing record boundaries and ownership names, at least one centerline alignment, and the proposed right of way limits. It should be produced to mapping standards at the requested scale.

- d. Title Map - This will graphically show the section lines, quarter section lines, sixteenth lines, and corresponding corners of the Public Land Survey. The limits of this mapping will follow along a corridor of properties that will be affected by areas of proposed construction or development by Mn/DOT.

The maps used for showing titles can be existing right of way maps, half-section maps, township plat maps, or new maps prepared with the required data. They do not need to be developed to mapping standards and need not show dimensions.

This map is usually furnished by the District Surveys Unit to the District Right of Way Unit. They in turn will indicate on the map the areas of land that may be affected. This will aid the attorney doing the title work. See 5-491.104 in the Mn/DOT Right of Way Manual for additional policy and procedure.

- e. Right of Way Work Map - This map will be drafted to mapping standards and will be used in the right of way acquisition process for computing plats, writing legal

descriptions, preparing commissioner's orders, determining land values, and securing staff and Federal Highway Administration approval.

This map is the basis of the future permanent right of way map. District Surveys furnishes this map with the following necessary data drafted and properly labeled:

1. All visible topography, underground utilities, wells (used or unused) within 20 ft of Mn/DOT right of way, drainage ditches, and structures, including culverts, tile sewer systems, etc.
2. Alignment data.
3. Existing rights of way on public roads, railroads, and utilities.
4. Section lines, quarter section lines, sixteenth lines, and corresponding corners of the Public Land Survey, lots and blocks, subdivisions, towns, corporate limits, and other property lines.

This map is routed to District Design and R/W Units to add the construction limits, proposed R/W, temporary easements, access control, building removal, ownership grids, and captions. For more specific and detailed information, see 5-491.108 in the Mn/DOT Right of Way Manual.

f. Right of Way Staff Authorization Map

1. **Acquisition:** The right of way staff authorization map (see Right of Way Manual 5-494.108) is a print of the right of way work map showing the proposed acquisition in red and existing R/W boundaries in green. The staff authorization map gives the people who must approve and sign it an opportunity to make recommendations for changes in the right of way before acquisition begins. The staff authorization map must be approved and signed by the following people in the District: Design Engineer, Right of Way Engineer, and District Engineer. The staff authorization map is circulated through the Central Office for approval and signing by the following: Director, Office of Design Services; Director, Office of Land Management; and Division Director, Technical Services. When the staff authorization has been approved by the preceding, the District Surveys and/or Right of Way unit should do the final computations of the plat boundary corners (see Chapter 3).
2. **Turnback/Reconveyance:** The Office of Land Management has directed that all turnbacks/reconveyances should be routed through and/or discussed with the District Surveys Unit. At an early date, the District Surveys Engineer/Surveyor should contact the turnback unit in the Central Office to identify the data and mapping needed to describe the turnback properly. For detailed information on turnbacks, see 5-491.128 in the Right of Way Manual and Section 3-11.04.

- g. Right of Way Map - A right of way map is a graphic depiction, compiled from official documents of record and filed in the Office of Land Management in the Central Office, of right of way interests acquired by Mn/DOT. Right of way maps should not be used for determining boundaries. Accurate location of the right of way lines requires additional research and survey data.

Generally, a new right of way map is prepared for all projects on new locations and for betterment projects that involve extensive changes. On some reconstruction jobs, a previously filed right of way map from an earlier project can be used to show

new alignments, survey data, and right of way. The decision on whether to make a new map or to use an old one must be made in conjunction with the Land Information Systems and Right of Way Mapping Unit in the Central Office.

Several sections are involved in the development of the map: Photogrammetrics, District Surveys and R/W, and Office of Land Management for preparation prior to acquisition. For more information on Right of Way Maps, see Section 3-5.

5-6.0509 *Plats*

Plats are produced by surveys for the purpose of making record property boundaries easier to visualize and locate and to facilitate the transfer of property rights.

There are currently two types of plats, with a third type under development:

- a. Acquisition Plat - Produced for the purpose of acquiring right of way. The plat drawing becomes the property description of the parcels to be bought and is referred to in the warranty deeds. These plats are authorized under Minnesota Statute 160.085.
- b. Monumentation Plat - Produced for the purpose of graphically depicting boundary lines of right of way owned or controlled by Mn/DOT. These plats are authorized under Minnesota Statute 160.14.
- c. Conveyance Plat (currently under development) – Produced for the purpose of transferring complex or multiple properties to another owner. The plat drawing becomes the property description of the parcels to be conveyed by Mn/DOT and is referred to in the warranty deeds. These plats are authorized under Minnesota Statutes 160.085.

The decision whether to use the Plat Reference System or the Metes and Bounds Description System on a project requires liaison between the District Right of Way Unit, the District Surveys Unit, and the Central Office Platting, and Legal Descriptions and Commissioner's Orders Units.

The Central Office Platting Unit has produced a booklet titled "R/W Plat Standards and Drafting Details" to be used as a guide for those producing monumentation and acquisition plats. See Section 3-7, Right of Way Plats, for more detailed information on the development and processing of plats.

5-6.06 TYPES OF DOCUMENTS MADE

Three kinds of land surveying documents are prepared in the District Surveys Unit: Certificates of Location, Certificates of Survey, and Registered Land Surveys. These in effect are small, special-use maps showing specific information to be recorded in the public records.

5-6.0601 *Certificate of Location of Government Corner*

This document is used to report and record the data pertaining to the placement of land corners. The document can be prepared on Form 2105 or in other formats acceptable to county recorders. See Section 3-4 for instructions on the preparation and filing of this document.

5-6.0602 Certificate of Survey

A Certificate of Survey is a drawing at an appropriate scale that depicts the boundary of a given parcel of property, the visible planimetric features, and the record description of the property, along with normal graphic information as suggested in the Minnesota Society of Professional Surveyors "Minimum Standards" document.

This drawing is used to make written descriptions easier to understand through the use of graphics, and to show the relationship of planimetric and record boundary elements.

All Certificates of Surveys should be filed at the County Recorders Office. Copies must be sent to C.O. Platting Unit and included in the parcel files.

5-6.0603 Registered Land Survey

A Registered Land Survey is a property survey that can only be used with a property whose title has been registered in the Torrens System. This type of survey is covered and controlled under Minnesota Statute 508.47. This survey may be performed for splitting torrens property, held by Mn/DOT in fee, for possible reconveyance or acquisition.

The survey drawing is subject to review by County Surveyors, where ordinances and regulations so require.

This survey is representative of record boundaries and distances only.

5-6.07 BRIDGE SURVEY SHEETS

Bridge Survey sheets are required for bridges and for box culverts 54 inches and larger. Bridge Survey Sheets typically are prepared by District Surveys Units from survey data and from observations made at the bridge site. The purpose of the Bridge Survey Sheets is to show graphically the necessary field survey data and control used for the location and design of a bridge and to initiate the hydraulics recommendations for a waterway crossing.

See Section 5-5.03 in this manual on Bridges for a complete explanation of the information gathered during the survey. The Bridge Hydraulics unit should be contacted for any questions involving the amount of information needed for stream crossings. Some field work is often needed to produce elevations under bridges, below water surfaces, and at other locations where aerial surveys are blocked by vegetation. For some deeper stream or lake crossings District Surveys may contact the Bridge Hydraulics Unit to check availability and feasibility of obtaining streambed elevations using a boat and sonar equipment.

Generally, there are two types of sheets for each proposed bridge construction. The first type of sheet shows the in-place plan and profile, typical sections, observations, hydraulic and foundation recommendations, and final grade. The second type of sheet shows a larger scale plan.

Additional sheets may be required to show special features such as topography, profiles, cross-sections, proposed channel changes, etc.

The general development of the Bridge Survey Sheets in the District, involves the following steps:

- a. The District Surveys Unit drafts the field survey data on the sheets and transmits them to District Design.

- b. District Design requests determination of type and depth of structure from the C.O. Office of Bridges and Structures to establish grades. When this data is received, it is entered onto the sheets by Design and submitted to the Bridge Engineer in the C.O. Office of Bridges and Structures for further development.

Or, depending upon the factors involved in scheduling, these development steps may proceed as follows:

- a. The District Surveys Unit originates and prepares the Bridge Survey Sheets and also organizes and presents the assembled hydraulics investigation information.
- b. The District Surveys Unit sends the original Bridge Survey Sheets to the C.O. Office of Bridges and Structures, and gives copies to any other district unit that is interested or involved, such as Design, Hydraulics, R/W, Soils, etc.
- c. District Design requests type and depth of structure from the C.O. Office of Bridges and Structures, and after receiving this information, District Design determines the bridge profile grade. The profile grade is then sent to the C.O. Office of Bridges and Structures, where it is entered on the original bridge survey sheets.

The preliminary bridge survey sheets should be submitted using the following time frame:

<u>Bridge Type</u>	<u>Months Before Letting (does not include R/W)</u>
Railroad	22
Major River	33
Road & Other	20

The bridge sheets should be produced in the following sequence and should contain the information noted:

- a. Standard Bridge Survey Sheet

The “Plat Area” shows all planimetric features including alignments, topography, property lines if available, and utilities. If planimetric data is to be submitted on another sheet, the plat area may show only alignments of bridge survey line and any crossing alignments, depending on the density of features. The sheet should not appear cluttered.

The area above the plat box (“Contracted Profile”) is used to show the profile of the bridge survey centerline profile with a 10 to 1 expansion of the vertical scale compared to the horizontal scale. For stream crossings the in place low member elevation and water elevation at the time of the bridge survey should be shown.

The grid area in the center of the sheet (“Typical Sections and Pertinent Data”) is usually reserved for profiles of crossing centerlines (railroad or road) or typical cross-sections of floodplains that are usually drawn at the same scale as the “Contracted Profile”. If all three areas are not needed, alignment information text may be placed in the bottom of the three boxes.

On the right hand side of the sheet, the areas usually filled out by surveys are:

1. "Location Engineer's Observation at Bridge Site" (if necessary)
2. Bench Mark Elevation
3. Bridge Survey
4. Index Map

b. Alignment and Profile Bridge Survey Sheet

More than one of these sheets may be needed, depending upon length of bridge.

The top half of each sheet shows the main alignment and intersecting alignments, and the bottom half shows ground line profiles. For stream crossings show water surface and stream bed profiles.

Usually the bridge centerline profile is plotted, along with profiles, at pre-determined distances left and right. Each line should have a separate, distinct line pattern. The horizontal and vertical scales should be equal. For stream crossings provide channel cross sections upstream and downstream per figure 5-5.0314.

These sheets are used to show soils information, inplace and proposed grades, and plan and elevation of proposed bridge.

THE FOLLOWING SHEETS ARE OPTIONAL:

- a. Alignment Tabulation Plan Sheet - Shows new design alignments to be constructed.
- b. Planimetric Sheet - Shows the inplace planimetric features and alignment. If contours are available they may be included on the sheet to make it a topographic map.

This sheet should be plotted at a larger scale for urban areas. If urban, utilities should be on a separate sheet. R/W should be shown on this sheet.

- c. Utility Sheet - Shows streets and utilities at a large scale.

IN ADDITION:

- a. All sheets should have north arrows and scale bars. Lettering should follow Mn/DOT CADD Standards.
- b. Copies of all sheets and notes should be sent to Design, and a copy should be retained by Surveys.

See Section 5-5.03 in this manual for field survey requirements.

5-6.08 GRAVEL PIT SHEETS

A pit sheet is a specialized map that shows "both topographic and geological characteristics of the particular vicinity." The Pit Sheet showing the topographic characteristics is usually prepared in the C.O. Aggregate Unit from district survey data.

The Test Hole Data Sheet shows the geological characteristics for the pit and is needed, along with the pit sheet, to analyze the material. This sheet gives the following information for all the test holes: elevation and overburden, sample gradations and areas of no sample, depths, pertinent driller's notes, weighted averages, bottoms, depths on legend, water table, and remarks about the drilling and sampling.

The original pit sheet is prepared following the Technical Manual's drafting standards for symbols and line widths. Generally the sheet is laid out at such a scale that it can be read easily when included in a set of road plans.

The following is a typical list of information shown on the pit sheet: test holes, land lines, property lines, ownerships, survey base lines, road or highway alignments, R/W lines, government corners, streams, lakes, woods, swamps, bluffs, banks, bench marks, survey monuments, all buried or aerial utilities, fences, buildings, proper names of features, azimuth or bearing of lines, edge of open pit, toe of slope on deep pits, pit bottom elevations, agreement limits, date of last condition survey, stripping, stock piles, and waste piles.

It is especially important to have a clear, accurate, recognizable index map, so that the pit can be easily located in the field. Show the location with respect to a trunk highway junction, a trunk highway and a town together, a trunk highway alone, or a town alone. Restrict the location to a single township if none of the other options fits in the space available.

The C.O. Aggregate Unit has a checklist available for use in pit sheet layout and drafting.

5-6.09 SITE MAP

A site map is a small area map, such as a map of a building site, a radio tower, a maintenance truck station, or a roadside rest area, that is used for the design purposes by an architectural firm or by Mn/DOT's C.O. Building Unit.

It may contain all or only a portion of the mapping elements identified in Section 5-6.0203, such as: planimetrics, utilities, record boundaries, contours, and spot elevations. Generally, the only alignment placed on the map would be a referenced base line, if used for the field survey work.

Every site map should have a vertical datum clearly identified and a vertical control monument identified, within or closely adjacent to the map, in order to provide easy access to vertical control during construction.

The site map varies in size and depends upon the area being mapped and the scale used, but the most desirable size is one that fits in a full size set of plans.

5-6.10 SKETCHES AND EXHIBITS

Sketches and graphic exhibits are normally created to depict a specific problem graphically or clarify a specific feature visually.

Sketches and exhibits are not drafted to mapping standards, and they may be done at any scale or color, depending upon the need. The horizontal and vertical scales should be placed on the drawing. A north arrow should be shown, as should the plan view or profile view designation. A date and title block stating what is being shown and where it is must also be placed on the sketch or exhibit. The initials of the drafter must be shown. Labeling of individual items to show size, type of material, condition, length, height, width, identity, etc. must be done to avoid cluttering that may make the sketch or exhibit difficult to read.

5-6.11 AIRPORT MAPS

This mapping is for airport development and is sometimes performed under a Technical Services Agreement for counties and municipalities, or as requested by the Mn/DOT Office of Aeronautics. The purpose of this mapping is to provide data for airport design, R/W acquisition, and construction.

Property maps, utility layout maps, and site maps are examples of maps that have been used for airport development purposes.

Aeronautics has its own criteria and format of information to show on maps, so it is necessary to consult with them to determine their requirements.

5-7 NOTE FORMS

5-7.01 INTRODUCTION

The location field notes and the annotated planimetric map become the record of the survey. This information, collected for the design process, must be reliable, the format must be standard, and the notes must be neat and clear to allow only one interpretation.

Notes and mapping could be used as evidence in a court of law; therefore, note forms must comply with established standards.

Electronic data collection and computer forms should be used in place of written notes whenever possible. Electronic data files should contain information in their headers to identify the date, type of survey, weather conditions, and any other information specified by the District Surveyor. Copies should be kept of the original, electronic filed data files.

If written notes are used, the following standards and format sections will apply:

5-7.02 STANDARDS

- a. Never erase. Line out errors so they can still be read. Do not write one figure over another.
- b. Never write the word "VOID" on notes. The word by definition renders the notes "of no legal force or effect." If changes have been made, mark the notes "REVISED", carefully explain why, and refer to the revised notes. Then sign and date the comments.
- c. Always sign and date each group of notes and identify the group.
- d. Don't make unrecorded changes in the field measurements, e.g., don't change the rod readings on a cross-section to allow for topsoil. If topsoil thickness is needed, measure the depth occasionally and make comments in the notes.
- e. Avoid possible confusion as to the datum when cross-sectioning or profiling by always referring to established bench marks. Never change the elevation of a bench mark without a thorough explanation. Make every effort to end on a different bench mark or a temporary bench mark.
- f. Always record directly in the field book; do not use scrap paper.
- g. Don't crowd the notes; expand the scale if necessary.
- h. Use sketches and/or explanatory notes if needed to clarify measurements. Show a north arrow on sketches, and indicate whether the sketch was drawn to scale.
- i. Place a zero before the decimal point for numbers less than one.
- j. If a survey crew diary is kept, it should be brief and factual. Don't editorialize. The possibility exists that it could become evidence in litigation, and any carelessly worded remarks could be detrimental.
- k. Never use a red pencil, which is reserved for use by the Finals Squad.
- l. Use SI symbols as per ASTM E-380.
- m. Use only those abbreviations accepted by Mn/DOT and shown in Section 5-292.002 of the Mn/DOT Technical Manual.

5-7.03 FORMAT*5-7.0301 Title Page*

All notes should have a title page, whether the work covers the entire project or just a segment of it. The title page shall show the following:

- a. Trunk Highway Number
- b. State Project Number (Low S.P. if there is more than one)
- c. Type of Work
- d. Alignment Line and Stationing interval
- e. Date

5-7.0302 Body of Notes

Use the format specified by the District Land Surveyor or Surveys Engineer.

Required Bridge Hydraulic Survey Data

If the field review reveals that the most typical upstream cross section in the vicinity of the bridge is at a different location, then an additional cross section should be taken at that location.

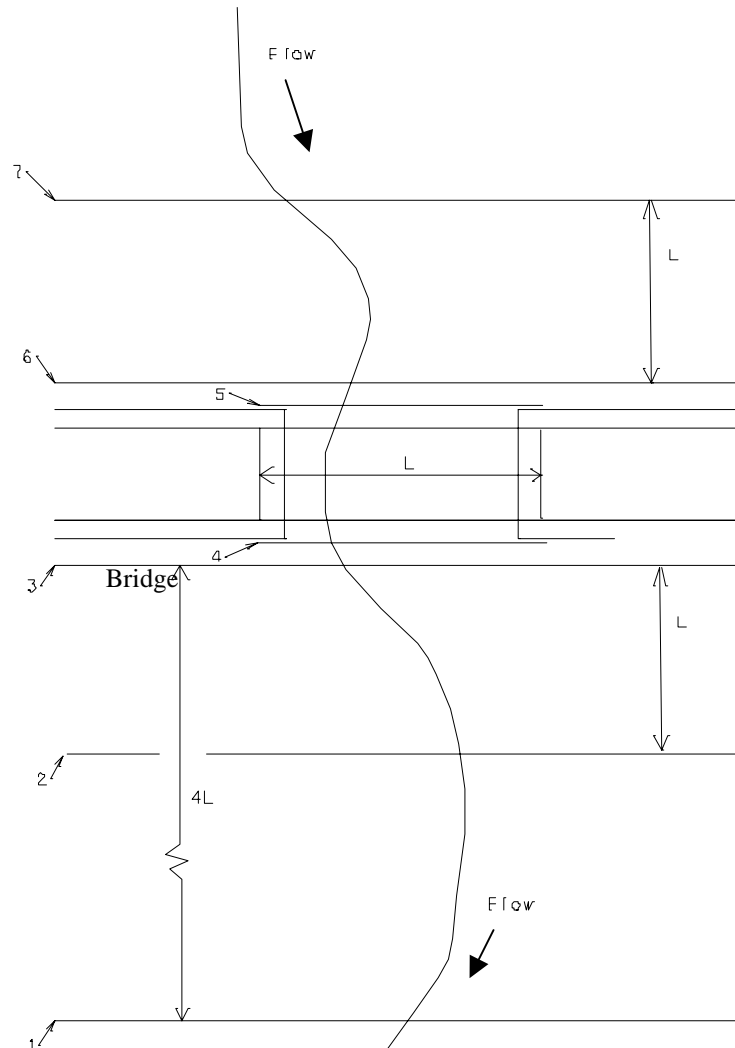

If the field review reveals that the most restrictive cross section downstream is at a different location, then an additional cross section should be taken at restrictive location.

Things to note while in the field:

- Lowest elevation at which upstream properties would be flooded
- Sour evidence/ history
- Boat passage requirement
- Ice or debris problems
- Maximum observed high water
- Stream profiles should extend 1000' upstream and 1000' downstream
- Existing roadway profile
- Roadway profiles and stream cross sections should be extended above the maximum high water mark.

Cross sections 3 & 6 should be 10' beyond the toe of slope.

Before going out in field, check with the District Hydraulics Engineer to determine if there is a Flood Insurance Study (FIS) that covers the location of the bridge/culvert. An FIS will likely reduce the required amount of survey information. Any questions regarding the required survey data should be directed to C.O. Hydraulics (651)-747-2100.

CHAPTER 6 - CONSTRUCTION SURVEYS**6-1 INTRODUCTION****6-2 PRE-CONSTRUCTION**

6-2.01 REVIEW PLANS

6-2.0101 Horizontal Alignment

6-2.0102 Vertical Alignment

6-2.0103 Typical Sections

6-2.0104 Planned Drainage

6-2.0105 Right of Way Limits

6-2.0106 Utilities

6-2.0107 Pay Item Documentation

6-2.02 PREPARE STAKING BOOKS

6-2.0201 Alignment Book

6-2.0202 Grade Book

6-2.0203 Slope Stake Book

6-2.0204 Blue Top Book

6-2.0205 Drainage Structure Book

6-2.03 FIELD WORK

6-2.0301 Alignment

6-2.0302 Supplementary Bench Marks

6-2.0303 Land Corner Ties

6-2.0304 Check Existing Structures

6-3 CONSTRUCTION

6-3.01 COMMUNICATIONS

6-3.0101 Pre-Construction Conference

6-3.0102 Surveyor-Contractor Relationship

6-3.0103 Surveyor-Inspector Relationship

6-3.02 STAKING

6-3.0201 Clearing and Grubbing

6-3.0202 Muck Excavation

6-3.0203 Slope Stakes and Key Stakes

6-3.0204 Culverts

- 6-3.0205 Grading Blue Tops
- 6-3.0206 Borrow Pits
- 6-3.0207 Storm Sewer
- 6-3.0208 Curb and Gutter
- 6-3.0209 Paving
- 6-3.0210 Fencing
- 6-3.0211 Signs
- 6-3.0212 Bridges
- 6-3.0213 Noise Walls

6-4 POST CONSTRUCTION

6-4.01 FINAL MEASUREMENTS

- 6-4.0101 General
- 6-4.0102 Final Cross Sections
- 6-4.0103 Muck Excavation
- 6-4.0104 Structures
- 6-4.0105 Final Plans

6-4.02 MONUMENTATION

- 6-4.0201 Final Alignment
- 6-4.0202 Right of Way
- 6-4.0203 Bench Marks
- 6-4.0204 Horizontal Control Stations

6-5 NOTE FORMS

6-5.01 STANDARDS

6-5.02 FORMAT

- 6-5.0201 Title Page
- 6-5.0202 Other Pages

6-5.03 EXAMPLES OF NOTE FORMS

- 6-5.0301 Alignment Notes
- 6-5.0302 Clearing and Grubbing
- 6-5.0303 Muck Excavation
- 6-5.0304 Slope Stakes and Key Stakes
- 6-5.0305 Culverts
- 6-5.0306 Blue Tops

- 6-5.0307 Borrow Pits
- 6-5.0308 Storm Sewer
- 6-5.0309 Curb and Gutter
- 6-5.0310 Paving
- 6-5.0311 Fencing
- 6-5.0312 Signs
- 6-5.0313 Bridge Notes
- 6-5.0314 Bench Levels

CHAPTER 6 - CONSTRUCTION SURVEYS

This chapter is written at the level of Survey Crew Chiefs who have had highway construction staking experience and are knowledgeable in the elements of surveying which include simple curve computation and layout, spiral curve computation and layout, vertical curve computations, coordinate geometry, slope staking, blue topping, structure staking, instrumentation, and note keeping. The material presented herein is intended to be self-contained and sufficiently complete so that an experienced construction surveyor can use it on a typical highway project. However, the following Mn/DOT Manuals may be required for additional reference material (also refer to standard staking information sheets 5-297.115 for staking data.).

- Standard Plates Manual
- Road Design Manual
- Construction Administration Manual
- Technical Manual
- Drainage Manual
- Bridge Construction Manual
- Contract Administration Manual

In districts operating with a central surveys section, the District Surveys Supervisor will provide the necessary construction surveying personnel as needed, depending on the scope of the project. Small projects will be furnished with only a temporary crew while large projects will require either full time crews or a combination of both. Crews assigned full time should work in conformity with the project engineer for the duration of the project.

In districts not yet organized under the central surveys concept, construction crews will usually be organized by transfer from other sections in the district to the direct supervision of the project engineer on a seasonal basis.

This chapter is written from the perspective of a survey crew under Mn/DOT control. While much of the information also applies to the Contractor Construction Staking situation, there are some differences. For more information/guidance on Contractor Construction Staking, see APPENDIX A of this manual.

6-1 INTRODUCTION

Highway construction surveying can be classified into three categories: pre-construction, construction, and post-construction. The survey crew, along with the chief inspector assigned to a project, is responsible for conducting all surveys required in connection with making the necessary measurements to determine pay quantities. The survey party chief has the primary duty of making certain that the State's obligations are met with regard to furnishing the necessary stakes and information needed to construct a project.

6-2 PRE-CONSTRUCTION

When a construction surveyor is assigned to a construction project he/she should carefully study and check the plans and special provisions. Any errors or omissions of significant proportion shall be brought to the attention of the project engineer, who will take the necessary steps to resolve them. The State's position on these must be established prior to the pre-construction conference with the contractor. A thorough review not only detects errors, but also helps familiarize the surveyor with the project. He/she becomes better prepared to plan his operations when actual construction begins. Pre-construction plan review, note preparation, miscellaneous computations, and field work are essential for a smoothly operating construction project.

6-2.01 REVIEW PLANS

Before beginning any pre-construction activities involving computations, it is recommended that communications be established with the designer of the project in order to avoid any duplication of effort. He/she may have work sheets and/or miscellaneous computations used for design purposes that could be useful to the surveyor. Some information available may include:

- a. Horizontal alignment.
- b. Vertical alignment.
- c. Pivot point distances and elevations.
- d. Slope stakes and reference blue tops in electronic format.
- e. Electronic plan files
- f. Typical sections

6-2.0101 *Horizontal Alignment*

Planned alignment should be checked for the following:

- a. Construction centerline with respect to right of way limits. Compare construction limits with right of way line. If construction limits are outside the right of way the discrepancy should be brought to the attention of the project engineer.
- b. Station Equations. On parallel divided highways stationing is usually the same for both lanes except on curves. The equations at the ends of the dependent lane should be checked for compatibility with the controlling lane.
- c. Ramp and Loop Closure. Ramps and loops should be checked mathematically before being laid out in the field. If they don't close, steps shall be taken to resolve the errors. If a loop does not close, it is generally best to leave the ends alone and revise the alignment in between, since panel layouts and ramp noses would otherwise be affected. Any discrepancy should be brought to the attention of the engineer.
- d. Construction centerline with in-place bridges. The bridge plans should be checked with the grading plans to see if they match. In some cases a field check should be made to determine the plan location of the in-place bridge. If discrepancies are noted between plans or an in-place structure the project engineer should be notified.

6-2.0102 *Vertical Alignment*

Vertical alignment should be checked for the following:

- a. Flat grades. When centerline profile grades are extremely flat, special ditch grades are necessary to avoid ponding.
- b. Bridge clearance. The minimum bridge clearance for highways and for railroads should be checked. While this check can be made by referring to the bridge plans, it is highly recommended that the elevation of the low part of the in-place bridge be checked in the field. If the minimum requirements are not met the project engineer should be notified.
- c. Low points under bridges. Vertical curve low points are permitted and desirable within 100 ft of a bridge.

- d. Low, wetland clearance. In swampy and/or other low, wetlands, the profile grade should be at an elevation that will result in a desirable minimum of 5 ft clearance between the low shoulder and the water elevation (see Road Design Manual Figure 4-6.03B).
- e. Side road and entrance grades. Vertical alignment should be checked for drainage design criteria.
- f. Shifted centerline. In some cases the horizontal alignment is shifted laterally. If this happens consideration should be given to possible shift in vertical alignment. Care should be taken to make sure the computer operator is aware of the situation if computer grades are to be used.
- g. Bypass and/or temporary connections should be checked for matching existing roadways. A field check is preferable.

6-2.0103 *Typical Sections*

Typical sections should be checked for the following:

- a. Designation of profile grade. Profile grades are not always on the centerline alignment. On multi-line divided highways, the profile grade could be on the edge of the lane nearest the median. To do otherwise may result in problems with the median when in superelevation.
- b. Compatibility with thickness shown on the plan-profile sheets. If the profile grade is on the centerline, the thickness shown on the profile might not be the same as that shown on the typical section, since the sub-grade and finished grade will diverge or remain parallel.
- c. Grading widths. The grading widths on typical sections should be checked. If mistakes are found on the typical sections the project engineer should be notified. Grading widths should be computed at recommended staking intervals as per standard staking information sheets No. 5-297.115 on non-typical sections such as tapers and for superelevation. See Technical Manual 5-292.505 for the methods of computation.
- d. Limits of stationing. The general layout sheets are useful for this. A color-coding system will expedite the procedure. If discrepancies are discovered, the project engineer and/or designer should be notified to decide which to use.
- e. Weak shoulders. Shoulders on the high side, when on super, do not contain as much gravel as on a normal section due to the convergence of the sub-grade and the finished shoulder grade. In cases where the typical section is thin, the outer portion of the shoulder doesn't have any gravel. An additional hip point should be staked at the rollover point on the sub-grade with the pitch being the same as the finished shoulder.

The project engineer and designer should decide at what point this should be done. The example in Figure 6-2.0203B is a borderline case. (See Road Design Manual Figure 7-4.01B)

- f. Crown points. Inverted crown is never to be allowed. For example, if a traffic lane were on full super, the shoulder pitch on the low side should continue at the same pitch, rather than become flatter. To do otherwise would result in snow removal problems, damage to the shoulder, and damage to snow removal equipment. An exception to this rule is alleys where an inverted crown is desirable.

- g. Cross sections. Check to see if plotted cross sections match the appropriate typical.

6-2.0104 *Planned Drainage*

The most important thing to look for when reviewing the general drainage plan on a project is the natural run-off. Any disruption of the natural run-off that causes damage to others is almost certain to result in a claim against the State. The chances of finding a mistake of this type are remote; however, a field check should be made to ascertain that a desirable result is accomplished.

A recommended method of drainage review is to draw arrows showing direction of flow on the plan sheets and compute elevations to the nearest foot at critical points if there are no contours. Drainage is easier to visualize on a contour-designed project since the drainage is at right angles to the contour lines. Another useful feature of contours is the fact that in cases of ditches and gullies, the contours point upstream.

Arrows showing direction of flow will further clarify the analysis.

Specific things to look for when reviewing planned drainage include the following:

- a. Median ditch blocks. Generally, depressed median ditch blocks are spaced at intervals from about 00 ft to 1200 ft, depending on the steepness of the ditch grade.
- b. Cut run-out ditch blocks. Ditch block with metal pipe flumes and surge basins or riprap are usually required where the ditch ends and fill section begins since this area is obviously vulnerable to washouts. Sodded flumes are sometimes used when the transitional ditch grade is about 2% or less. See Road Design Manual 8-5.01.07 through 8-5.01.08.
- c. Increasing structure size. As a general rule, drainage structures such as culverts and storm sewers should increase in size in the downstream direction. An exception to this rule is the use of reducers. Reducers are used in storm sewers and culverts in places where there is an abrupt increase in the flowline grade. The resulting increase in pipe capacity allows a reduction in pipe diameter and economy in design.
- d. Compatibility between cross section sheets and drainage sheets. If culvert dimensions shown on the cross sections disagree with those on the drainage sheets, the designer should be contacted to determine which to use.
- e. Catch basins at ramp noses. Catch basins should be installed adjacent to ramp noses to catch water that would otherwise cross the ramp and cause a hazardous icing condition. Ramp grades and supers will help to make this determination.
- f. Compatibility with previously placed structures. When a large project is constructed under two separate contracts, the sub-surface part of the drainage structures are usually installed under the grading contract and the castings and curb returns added later under the paving contract. When reviewing the paving plan, it should be compared to the grading plan for compatibility with regard to vertical and horizontal position, and type of structure.

6-2.0105 *Right of Way Limits*

The right of way should be compared to the construction limits to ensure that no encroachments will occur. Most of this can be scaled from the cross sections and plotted on the map. Slope easement expiration dates also should be checked. If a slope

easement is likely to expire before the work will be finished, the engineer should be notified so that it can be extended. In cases of encroachment where no slope easement exists the project engineer should be notified so that a corrective action can be taken.

6-2.0106 *Utilities*

Utilities are defined as all facilities that produce electricity, communications, gas, water, sanitary sewer, storm sewer, lighting, signals, steam, petroleum, and other similar products that serve the public regardless of ownership.

See the Mn/DOT Utility Manual for symbol identifications.

Before beginning a review of utility location, communications should be established with the utility inspector, since he/she not only has the permit descriptions and utility plans, but also reviews them. While the inspector is primarily concerned with proper design policy, the surveyor is more interested in discovering the conflicts with highway installations. Some of the things to look for include the following:

- a. Compatibility of underground elevations. The elevations of proposed or an in-place utility should be checked to make sure there is no conflict with highway installations such as storm sewers, culverts, bridge footings, sub-cuts, etc. Plotting of these buried utilities on the cross sections is a helpful method of analysis.
- b. Highway crossings. Attempts should be made to cross at right angles to centerline.
- c. Horizontal clearance. Power poles are not to be located within the required clear zone for any planned future highway improvements along that section of highway. When highway improvements are not planned within the foreseeable future poles are to be located within the outer 5 ft of the highway right of way. Poles are not allowed in medians (defined as the area between inside shoulder points) 80 ft wide or less.
- d. Sufficient cover. Water mains must have at least 6 ft of fill to avoid freezing unless provisions have been made for insulation.
- e. Alignment location. On new freeways, utilities cannot be installed longitudinally nor can they be serviced by access from mainlines, ramps, or loops. In cases where a utility is in-place longitudinally on a highway that is to be upgraded to freeway standards, it may remain as is provided that it can be serviced without access from the through-traffic roadways or ramps.

Utility relocation and new installations are designed and staked by the utility company's forces, or in some cases, by a consultant if the utility does not have the necessary personnel. The construction and/or relocation is performed at various stages of the highway construction. The project engineer has the authority to inspect all utility work. This includes checking proper alignment, location, and grade. Most of this is usually checked by the utility inspector, but in certain situations the survey crew must be called upon for assistance. An example could be in a large cut area where the grading is only roughly completed. If an underground facility were involved the crew would stake the bottom of the sub-cut so the utility could be installed without conflicting with the highway construction. Power lines are usually located in the outer 5 ft of right of way, buried cables and gas mains are located in the outer 10 ft. This is another reason a crew might be called upon to stake the right of way.

6-2.0107 Pay Item Documentation

Most of the documentation is recorded by the inspectors during construction. However, during the pre-construction plan review each item should be examined to determine where the responsibility lies for documentation. In some cases where it is not practical for the inspectors to make the measurements (e.g. swamp excavation, borrow pits, etc.), the survey crew may be called upon to make the measurements. Cases where either the survey crew or the inspectors can be responsible shall be decided by the project engineer. The Contract Administration Manual and the Standard Specifications for Construction Book (Specification Book) should be reviewed for measurement details.

6-2.02 PREPARE STAKING BOOKS

Much of the note keeping can be done in the office prior to actual construction. The purpose of this is to avoid errors and delays during the staking operation. In addition, the notes will be more orderly and better organized if properly set up in advance.

6-2.0201 Alignment Book

A hard copy report should be kept of all electronic alignment files intended to be used on the construction project.

6-2.0202 Grade Book

The grade book should be set up for the whole job in advance if possible. Areas such as superelevation transitions, ramp entrances and exits, auxiliary lanes, tapers, and bridge approaches should be given extra time to assure accurate computations are complete. If computer output sheets are used in the making of the grade book, sufficient care should be given to checking the accuracy of the electronic printout.

Centerline elevations, vertical curve data, and superelevation transition stationing should be shown on the left page. Superelevation transition pitches and ditch grades should be shown on the right page. Vertical curve offsets can be figured with appropriate Mn/DOT COGO software. When calculating superelevation rates and transitions, refer to Section 3-3 in the Road Design Manual.

When matching planned vertical alignment into existing bridges and roadways, it is not always necessary to recompute new vertical curve data if the differences are reasonably small, e.g., 0.2 ft. Planned grades may be altered slightly on a pro rata basis for one or two stations to match an in-place grade. This policy also applies to minor grade changes authorized by the Engineer.

In some cases, such as ramp and street intersections, it is necessary to lay grades for the curb radii. When doing this, care must be taken to avoid trapping water. In complicated areas, a panel layout should be drawn to a large scale, e.g. 1:100, to expedite the grade laying procedure. Arrows showing direction of flow should be included indicating the pitch and drainage direction. See Road Design Manual Figures 5-2.03B, C and D.

6-2.0203 Slope Stake Book

Notes should be set up for intervals not exceeding 100 ft. It is recommended that no more than two stations per page be set up in urban areas. This allows room for leveling notes, bench mark descriptions, miscellaneous computations, and additional shots. When setting up notes in sections other than normal, computations must be made involving the following variables: superelevation transitions, ramp centerline offsets, pivot point widths, and ditch bottom widths.

Ramp centerline offsets are needed at the end of an entrance ramp where a standard acceleration lane is to be constructed. The distance between the mainline centerline and ramp centerline can be figured either by using the table on the standard acceleration lane detail sheet in the plans or using the formula described in Figure 6-2.0203A. Escape lanes are similar except they employ a one-degree curve and no taper.

The distance to the grading pi is figured by dividing the typical section thickness (excluding sod and top soil) by the algebraic difference between the grading grade pitch and shoulder slope, and then adding the distance from centerline to the shoulder point. See Figure 6-2.0203B for an example.

Ditch bottom widths are figured either by using a table or solving them mathematically as shown in Figure 6-2.0203C.

Another useful item that should be entered into the notes is the scaled distance to the slope stake point taken from either the cross section sheets or the contour sheets. This not only serves as a rough check on the mathematical position, but also expedites the staking procedures.

When setting up notes for four lane divided highways it must be decided whether to stake each lane separately or both at the same time. The decision should be based on the method that will result in the least work. In rugged terrain, it will probably be advantageous to stake them separately. If both lanes are to be staked at the same time, the dependent lane will not always be staked at even stations around parallel, concentric curves. On computer-designed projects, the controlling lane is figured for even stationing while the dependent lane stationing will vary, depending on the horizontal alignment. It is recommended that the dependent lane be slope staked at whatever stationing is shown on the computer output, even though it is not always at even stationing. Later, when the fine grading is staked, even stationing should be used for both lanes as a matter of convenience.

A properly prepared slope stake book is a tremendous advantage to the surveyor when the stakes are needed, especially at sections involving transitions, tapers, and special ditch grades. Most of the computations can be done prior to construction and entered into the notes.

6-2.0204 Blue Top Book

Blue top notes should be set up in advance for mainline staking after consulting with the contractor for form. With the use of an automatic grading machine, the note form will differ greatly from a conventional project. A considerable amount of staking can be eliminated on projects where automatic grading machines are to be used.

Most of the information needed for subgrade blue tops can be found in the slope stake notes. Exceptions to this could include loops, turn lanes, and areas where curb and gutter is to be installed.

6-2.0205 Drainage Structure Book

Box culverts are staked by providing line and grade stakes in convenient locations as shown in Figure 6-2.0205. The staking book can be set up before construction, but the positions of the stakes should not be included until the structure is actually staked, since there is no way of predicting what the field conditions and/or obstructions will be at the time of staking. Additionally, the planned dimensions may be altered to fit on-site conditions. If this is done, the notes should clearly distinguish between the planned dimensions and the staked dimensions and give reasons why it was changed.

Centerline culvert notes can be set up ahead of time but may have to be altered slightly later depending on field conditions at the time of staking. The computed length, less the length of the aprons should be rounded off to the nearest even foot, since the sections are made that way. The computation involves details of the apron. See Standard Plates Manual.

Catch basin and man hole notes can be set up in advance but the stakes should not be shown since there is no way of predicting what obstructions might be in the way at the time of staking. Stationing should be checked for catch basins adjacent to ramp noses, which are intended to pick up water that otherwise would cross the ramp.

6-2.03 FIELD WORK

6-2.0301 *Alignment*

Alignment layout and alignment offset layout will be determined by the construction surveyor as staking procedures are needed.

6-2.0302 *Supplementary Bench Marks*

Supplementary bench marks should be placed, if necessary, at intervals of approximately 1500 ft.

When setting bench marks, it is important to positively identify the point. If a railroad spike is placed in a tree, for example, the height of the spike above the ground and the side of the tree where located should be noted in addition to the tree description. This procedure helps to avoid using a different spike placed by someone else.

If a Second Order bench mark has been destroyed or will be destroyed during construction, the District Surveys Supervisor should be notified so that it can be replaced using precise leveling procedures.

6-2.0303 *Land Corner Ties*

The project survey report should be carefully reviewed to determine which PLSS corners and property corners have been tied in to the coordinate system. The location of these corners should then be plotted on the plan sheets prior to beginning any field work. During the pre-construction field work (such as running line and setting additional bench marks) the crew members should look for land corners that were not plotted on the plan.

If any are found, the approximate positions should be plotted on the plan and the District Surveys Supervisor should be notified so they may be tied into the coordinate system. If there is no coordinate system, or if the Surveys Supervisor is unable to arrive before they are destroyed, they must be tied in by the construction surveyor. These land corners should be replaced after construction, and a Certificate of Location be filed with the appropriate governmental agency.

6-2.0304 *Check Existing Structures*

Existing structures that are to be incorporated into new construction should be checked for horizontal and vertical position after the above mentioned field work has been completed. Examples of in place structures to be checked include: bridges, box culverts, centerline culverts, catch basins, man holes, flumes, and concrete curb and gutter. If any discrepancies are discovered, the notes in the staking book will have to be modified or re-written. Any major discrepancies should be brought to the attention of the Project Engineer.

6-3 CONSTRUCTION

6-3.01 COMMUNICATIONS

Construction staking is to be provided as necessary to properly control the work. It is not necessary to provide survey stakes for every little detail. The engineer and the party chief shall exercise discretion to attempt keeping survey work to a minimum. If a project is large enough to require more than one survey crew, the project engineer or district survey supervisor shall assign one party chief the responsibility of coordinating the surveying activities.

Harmonious relations with the contractor are essential for a smoothly operating project. This condition is best accomplished through good communications between the contractor, the engineer, the surveyor, and inspectors.

6-3.0101 Pre-Construction Conference

Prior to the commencement of construction activities, a conference is held with the contractor, the contractor's supervisory personnel, and the State's engineering and surveying personnel. This meeting is of particular importance to the construction surveyor in order to plan and organize respective duties that conform to the contractor's planned sequence of operations to avoid any unnecessary delays or inconveniences. The contractor will outline the working schedule and methods of operations, and discuss construction details. The contractor should be asked to furnish the party chief a list showing the priority of staking needs. The contractor shall be advised of the requirement to give at least 24 hours notice for any deviation from the list. See Specification Book, Section 1803.2.

6-3.0102 Surveyor-Contractor Relationship

It is important that the surveyor establish a working relationship with the contractor and the foremen. A cooperative foreman will make the surveyor's job much easier and greatly reduce the possibility of errors. The contractor should be made aware of the importance of maintaining traverse stations and bench marks.

6-3.0103 Surveyor-Inspector Relationship

Since the inspectors work closely with the contractor in the actual construction of the project, it is advantageous for the construction surveyor to develop good communications with them. The inspectors are in a position to occasionally advise the surveyor on matters that can expedite the survey work.

6-3.02 STAKING

According to specifications, Mn/DOT is responsible for furnishing the contractor sufficient staking for the successful completion of the project. This is not to include re-staking due to the contractor's negligence. The contractor is obliged to preserve stakes set by the state personnel for as long as they are needed for the construction. Any re-staking needed because of the contractor's negligence shall be paid for by the contractor, as determined by the engineer. The replacement costs will be deducted from payment for the work. See Specification book, Section 1508.

The normal sequence of surveying activities on a typical project is usually as follows:

- a. Establish horizontal control network.
- b. Stake clearing and grubbing.
- c. Establish supplementary bench marks at approximately 1500 ft. intervals outside construction limits.
- d. Stake muck and/or swamp excavation.
- e. Set slope stakes and key stakes.
- f. Stake culverts that are vital to the construction drainage.
- g. Stake shoulder and center line at-grade blue tops for sub-grade.
- h. Stake storm sewers and other drainage structures as requested.
- i. Layout and take original x-sections or digital terrain models of borrow pits.
- j. Set at-grade blue tops at all break points, either for top of base or finished grade.
- k. Stake curb and gutter.
- l. Stake guard rail.
- m. Stake fencing.
- n. Stake overhead signs.
- o. Make final measurements for pay quantities.
- p. Monument final alignment, if not a plat reference project.
- q. Monument right of way.

Some of the above mentioned staking activities result in staking notes that are no longer of value to the surveyor once the item has been staked. Examples include: clearing and grubbing; culverts; storm sewers; curb and gutter; removals; etc. These notes should be kept for the correct retention schedule by the project surveyor.

6-3.0201 Clearing and Grubbing

When staking clearing and grubbing, attempts should be made to preserve trees and plant life of aesthetic value provided that the end result will not become hazardous to the traveling public. It is neither necessary nor desirable to clear everything within the right of way.

If payment is by the acre, the field measurements shall be made to points 10 ft outside the general line of the tree trunks (refer to the Administration Manual. 420, Spec. No. 2101).

Prior to the contractor removal operations, the notes may be turned over to the inspector to insure that the correct trees are removed, and for documentation purposes.

6-3.0202 *Muck Excavation*

The muck excavation limits shown on the cross sections are the result of the designer's estimate based on interpolations between soils borings. The actual depth could be different.

Since the computation for the position of the stake involves the elevation of the swamp bottom, it becomes necessary to scale this from the cross sections. The difference between the natural ground elevation (determined in the field) and the scaled elevation is then included in the stake computation. See Figure 6-3.0202 for details. The stake computation is actually two computations. The distance from the grading pi to the intersection of the planned backfill with the natural ground is determined by field measurement. The distance from that point to the stake is determined by the difference between the natural ground elevation and the scaled elevation mentioned previously. The grading pi elevation and distance from centerline can be taken from the slope stake book. The stake should show the cut, the slope, and distance to centerline.

If the swamp turns out to be deeper than shown on the plans, then the original computation for placing the stake is in error. After determining the difference between the scaled elevation and the actual swamp bottom, the stake shall be moved as shown in Figure 6-3.0202. The new information shall be added to the original stake (after lining out the old information) and entered into the notes along with an explanation, the date, and the crew chief's signature. When the inspector is satisfied that the swamp bottom has been reached, he/she should notify the survey crew so that elevations can be taken on the bottom for pay item quantities and/or documentation.

6-3.0203 *Slope Stakes and Key Stakes*

Slope stakes and their corresponding key stakes should refer to grading grade (bottom of top soil) unless conditions dictate otherwise.

During the slope staking procedure, the surveyor should be alert for any significant and/or systematic differences from the scaled, cross section position. If this happens, it should immediately be brought to the attention of the project engineer. See figures 6.5.0304 A, B, and C for slope staking note formants.

6-3.0204 *Culverts*

When staking culverts, the surveyor should refer to the Drainage Manual, Sections .301 through .303 for specific details.

- a. Location. As a general rule, centerline culverts should be located in the natural channel or waterway unless a channel change is to be constructed. In some cases it may be necessary to change the planned skew angle and/or stationing. The project engineer should be notified if any changes are anticipated.

When a road is to be constructed through a swamp and an equalizer pipe is necessary, consideration should be given to avoiding locations where settlement is likely to occur. Even in swamps backfilled with sand, displacement is possible in the deep areas.

- b. Length. The exact culvert length is not always known until the culvert is actually staked due to slight changes in topography. When the mathematical length between the ends of aprons has been determined, it should be reduced by the lengths of the aprons and then rounded up to the nearest even foot since culvert sections are constructed or fabricated in lengths which are multiples of two feet. This length should be entered in the notes and also on the culvert information so the contractor can select the appropriate sections of pipe.

When figuring skewed lengths, additional computations are necessary. A recommended method is to figure the length for a right angle crossing, divide this by the sine of the skew angle, and then recompute each end and allowances made for the convergence or divergency of the flowline with the roadway grade.

- c. Diameter or span. The minimum size pipe for centerline culverts is 24 in. The minimum size for side culverts and median drains is 18 in. The diameter of pipe should not decrease in the downstream direction.
- d. Cover. The minimum cover allowable for centerline culverts is 1.25 ft to the top of rigid pavements and 1.75 ft to the top of flexible pavements. Minimum cover is measured at the edge of pavement. In some situations it may be necessary to substitute pipe arch for round pipe in order to gain more cover. Another method is to substitute two or more smaller culverts for the planned diameter. Extreme cases could warrant a grade change. Any questionable case shall be brought to the project engineer's attention.
- e. Radius bends. Pipe bends should be avoided, if possible, unless there is no way to install straight sections. In some cases such as in urban areas and in the vicinity of bridge piers and slope protections, bends can't be avoided. In extremely close quarters, long and short radius sections could be combined. Radius bend details can be found in booklets published by the manufacturer.
- f. Camber. Under certain soil conditions, it may be necessary to stake culverts with a slight camber in the flowline grade. The amount shall be determined by the project engineer and the district soils engineer. In no case shall any part of the camber be at a higher elevation than the inlet flowline.

6-3.0205 *Grading Blue Tops*

The State normally provides the contractor with two sets of grading blue tops: one for subgrade, and the other for either top of base or top of finished surface, at the contractor's option. On a bituminous roadway, the second set would be for top of base. On a concrete roadway, the second set would be either top of base, if the paving is to be done with an auto-grader, or finished surface if form paving is to be used. On bituminous roadways with concrete curb and gutter, the second set would be to top of curb or toe of gutter, with additional base blue tops at any breaking points between the curbs. On projects where auto-graders are to be used, it may be possible to provide the necessary information for subgrade, base, and finished surface with one set of stakes.

Staking notes for auto graders cannot be set up without instructions from the contractor (at the pre-construction conference), since there are different types of machines that require different staking procedures. Some machines have sensors on both sides (and require stakes on both sides) while others have sensors on only one side and automatically control superelevation transitions and crown without any need for stakes on the other side.

The key points that control auto-grading are the bottom edges of slab. These points are connected with an imaginary straight line which is then produced laterally both ways to the desired offset distance specified by the contractor. The auto-grader is oriented to the grade line and in most cases, controls all layers of the typical section automatically. Stakes are either set to grade at the specified string line offset, or offset outside the string with information stakes, at the contractor's option. Stakes are usually set every 50 ft on mainline normal sections and every 25 ft on transitions and ramps. On superelevated pavement with crown removed, the crown is taken out mechanically by the operator. The beginning and end of transition must be staked for this operation.

6-3.0206 *Borrow Pits*

Borrow pits can be measured either with cross sections off a base line, by using a grid system, or by digital terrain model (DTM). If the pit is on or near the project, it should be referenced to centerline. If it is a considerable distance away from the project, steps must be taken to adequately reference the base line, grid system, or DTM. Any coordinate system should be referenced to the State Plane Coordinate system if feasible. Vertical control shall be referenced to the North American Vertical Datum of 1988 if at all possible, rather than an assumed elevation. It may become necessary to re-establish the pit location long after the completion of the project. The District Surveys Supervisor can provide advice.

6-3.0207 *Storm Sewer*

Storm sewer structures can be staked in one of two ways, at the contractor's option:

- a. The reference tie method has the center of structure and the two reference stakes forming a right angle, see Figure 6-5.0308A.
- b. The in-line method has the center of structure and the two offset stakes in a straight line, see Figure 6-5.0308B.

All catch basin castings should have a sump for the hydraulics of the structure to function properly. This sump shall be 0.10 ft when adjacent to a traveled lane and 0.20 ft in other situations. See the appropriate Standard Plate.

6-3.0208 *Curb and Gutter*

Curb and gutter is usually intended to function as a structure to contain water and delineate the edge of the roadway. On normal sections the stakes are placed with an offset to the back face of the curb, and the elevations staked to the top of the curb. One stake can provide both the tack line and the cut or fill to the top of curb. A special condition is "gutter out;" in which the water has run out of the gutter and across the roadway. Under this condition the critical elevation is the toe of the gutter, since this elevation controls the roadway grade and slope. This point should be staked by a cut or fill and a plus pitch in feet per foot on the gutter.

6-3.0209 *Paving*

Staking for paving depends on the method used by the contractors operations. When staking for form paving, one set of stakes can be used for both line and grade. This set of stakes is usually placed 1 ft to 3 ft from the edge of the slab. A tack can be placed on the top of the stake for line. The top of the stake is used for elevation to determine cut or fill. The other method of paving is slip-form paving. Staking for this method will be the same as described in Section 6-3.0205, Grading Blue Tops, in this manual.

Additional stakes should be placed at the stations of the following:

- a. Tapers and jogs.
- b. The beginning and ending of supers and crown removal transitions.

6-3.0210 *Fencing*

Fencing that follows the right of way line 1 ft inside should be staked under the supervision of the District Surveys Supervisor unless the right of way has already been monumented. Fencing not related to boundary lines can be staked by either the survey crew or the inspectors.

Stakes should be placed at every change of direction and at intermediate line points for the contractor's benefit. Corner posts shall be so noted if the change of direction is 20 degrees or greater.

6-3.0211 *Signs*

Staking procedure (line & grade) for signs and/or their footings are similar to box culvert staking and catch basin staking, i.e., line and grade information to the corners of the structure, or center at the contractor's option.

Sign plans are oriented to traffic direction, except if the message is in both directions then stationing governs. For this reason, the surveyor must be careful to avoid getting the left side mixed up with the right side. Signs should be skewed slightly (2 or 3 degrees) to avoid reflections from headlights.

Since signs are one of the last items installed on a project, care must be taken to avoid conflicts with buried utilities. The utility inspector should be consulted if there is any doubt about utility location. It may be necessary to modify the planned sign location. In event a sign is moved, the project engineer shall be notified.

For overhead signs with spread footings, a cross section must be taken on the in place slope or computed for a proposed slope. This cross section will be used to compute the bottom of the footing and top of pedestal. These elevations are then used by the contractor for quantities and by the surveyor for staking the footing, see Figure 6-5.0312. Overhead sign clearance must be verified in the field before staking.

6-3.0212 *Bridges*

The District Surveys Office, upon request, will assign a survey crew to layout the working points in accordance with the Bridge Layout sheet of the bridge plan. Measurements will be made with either electronic distance measuring (EDM) equipment or standardized tapes. All staking shall be done in accordance with the Bridge Construction Manual 5-393.052.

6-3.0213 *Noise Walls*

The design of a noise wall should be checked several weeks before the contractor starts his operations. The five items to be checked are:

- a. The proposed wall alignment should be run in the field to check that:
 1. The correct wall lengths are as indicated in the plans.
 2. The proposed post holes do not fall on underground utilities or structures.
 3. The wall heights will not conflict with existing overhead wires or structures.

If a conflict is encountered, the wall alignment may be shifted.

- b. Wall lengths should be checked to see that the even lengths of planking or paneling is divisible into the wall length with no remainder.
- c. The right of way should be located and the wall location checked that it is a minimum of 3 ft inside the right of way. The 3 ft clearance is necessary for wall maintenance.
- d. A center line profile of wall alignment is taken to check the plan profile. On post type walls, if the center line elevation of the ground of the proposed post location is more than 1 ft. lower than the plan shown a new post length is usually computed.
- e. The contractor should request a Gopher State One Call locate for utilities along the wall location. The survey crew should tie in the G.S.O.C. markings,, drainage structures, and overhead structures with respect to wall location. If necessary, wall alignment and post location may be shifted to miss utilities. Individual posts may be shifted along the wall to miss underground utilities, causing spacings of greater or less than shown on plan.

6-4 POST CONSTRUCTION

6-4.01 FINAL MEASUREMENTS

Most final measurements for pay quantities should be made concurrently with construction operations by inspectors. This procedure results in greater accuracy and reliability. Measurement of culverts prior to trench back-fill is one example. Other examples include:

- a. Removals
- b. Sub-Cuts
- c. Storm Sewer
- d. Salvage
- e. Conduit
- f. Buried Cable
- g. Clearing and Grubbing

Examples of measurements that can be made after construction include:

- a. Fencing
- b. Guard Rail
- c. Turf Establishment
- d. Structure Length Measurements (Pay Heights)
- e. Curb and Gutter
- f. Median Sidewalk
- g. Bridge Approach Panels

6-4.0101 General

All measurements for final payment made by the survey crew must conform to requirements according to instructions in the Contract Administration Manual, the Special Provisions and the Specification Book. It is especially important that no erasures or overwriting be permitted.

6-4.0102 Final Cross Sections

Final cross sections are used for the computation of final pay quantities.

6-4.0103 Muck Excavation

If the swamp area is under water at the time of taking the final cross section, a good method is to supplement the cross sections with soil borings taken later. It is possible to compile final cross sections from soil boring if a sufficient number of borings have been taken.

6-4.0104 Structures

Drainage structures (catch basins, manholes) are usually measured by the inspector at the time of placement. Any changes made in the horizontal or vertical location should be noted in the Final Plan sheets by the appropriate staff.

6-4.0105 Final Plans

The original plan sheets must be corrected to show any changes and additions made during construction. Under no condition should any of the original details be removed from the original plan sheet. All checks corrections, and additions should be made in black ink. All corrections and additions should be prefixed by the letter (F), in parenthesis.

The following list provides some of the pertinent information that must be checked, corrected, or added to the original plan sheets:

- a. Horizontal and vertical control including land corners and type of monument placed. The District Surveys Supervisor should be contacted.
- b. Changes in the typical section.
- c. Horizontal alignment (including curve changes and control point ties).
- d. Profile grades.
- e. All underground units (cable, conduits).

6-4.02 MONUMENTATION

Being more familiar with the project than anyone else at this point, the construction surveyor should be in charge of as much of the post construction monumentation as possible. However, if the construction surveyor must be transferred to a new project before completing the monumentation, the District Survey Supervisor should be notified so that steps can be taken to finish the job.

6-4.0201 Final Alignment

Every effort should be made to monument the final alignment prior to the project being opened to traffic. All P.I.s shall be monumented, or if inaccessible, the adjoining tangents shall be monumented. P.C.s and P.T.s should also be monumented. On plat reference projects it may be unnecessary to monument the centerline. All final alignment notes shall be submitted to the District Surveys Supervisor.

6-4.0202 Right of Way

Ideally, right of way should be monumented and marked prior to construction and maintained throughout. However, if the right of way must be re-monumented, it should be done under the supervision of the District Surveys Supervisor, since it involves land surveying. Upon completion, the notes shall be submitted to the District Surveys Office for review.

6-4.0203 Bench Marks

During the course of construction, the bench mark (B.M.) and temporary bench mark (T.B.M.) status changes continually. Many are destroyed and many are established. At the end of a project, a bench list should be made up tabulating all remaining B.M.s and T.B.M.s and submitted to the District Surveys Supervisor for possible future use.

6-4.0204 Horizontal Control Stations

On projects employing a coordinate system, efforts should be made to perpetuate the horizontal control stations after completing construction. The end result should be such that upon completion of the project, the stations can be found by means of a tie sheet, coordinates, and/or magnetic locator. All acceptable stations remaining should be shown on the final plan sheets. A copy of the information should be submitted to the District Surveys Supervisor.

6-5 NOTE FORMS

When surveying is performed for construction staking, the field notes become the record of the surveying. The importance of complete, legible, and accurate notes cannot be emphasized too strongly. The information given must be reliable, the format standard, and all books of notes must be clear and well arranged. It should be remembered that the notes are used by others and for this reason they must be so clear that there can be no possible chance of misinterpreting them. The possibility exists that they could be used as evidence in a court of law. If this was to happen and certain standards not followed, the State's case could be jeopardized. The notes become a permanent record and as such, must comply with the standards of Section 6-5.01 in this manual.

6-5.01 STANDARDS

Specific standards for various note forms will be covered under Section 6-5.03 in this manual. The following standards apply to all notes:

- a. Never erase. Line out errors so they can still be read. Do not write one figure over another.
- b. Never write the word VOID on notes. The word by definition renders the notes of no legal force or effect. If changes have been made, mark the notes "REVISED", carefully explain why, and refer to the revised notes. Then sign and date the comments.
- c. Always sign and date each group of notes and identify the group.
- d. Don't make unrecorded changes in the field measurements, e.g. don't change the rod readings on a cross section to allow for topsoil. If topsoil thickness is needed, measure the depth occasionally and make comments in the notes.
- e. Never leave any doubt as to the datum used when cross sectioning, profiling, or staking. Always refer to a known bench mark. Never change the elevation of a bench mark without a thorough explanation. Make every effort to end daily work on a different bench mark.
- f. Always record directly in the field book. Do not use scrap paper.
- g. Don't crowd the notes. Expand the scale if necessary.
- h. Use sketches and/or explanatory notes if they will clarify measurements. Show a north arrow on sketches. If a sketch is not to scale, indicate so.
- i. Place a zero before the decimal point for numbers less than one.
- j. It is not necessary to keep a survey crew diary. However, if one is to be kept, keep it brief and factual. Don't editorialize. The possibility exists that it could become involved in litigation and any carelessly worded remarks could be detrimental to the State's case. A weekly survey report form is available for keeping track of crew members, hours worked, weather, and staking progress. See Figure 6-5.01. This form may be used in place of a diary.
- k. Never use a red pencil on construction notes. This color is reserved for the Final Squad.

6-5.02 FORMAT*6-5.0201 Title Page*

All notes should have a title page whether the work covers the entire project or just a segment of it. The title page shall show the following:

- a. Trunk Highway number.
- b. State project number. (Low S.P. if there is more than one)
- c. Contract number.
- d. Type of work.
- e. Alignment line and stationing interval.
- f. Name of project engineer.
- g. Date.

See Figure 6-5.0201 for a typical example.

6-5.0202 Other Pages

The following information shall be placed on the other pages:

- a. The state project number, type of work, and centerline identification in the upper left corner of the left page.
- b. The names of the crew on the upper left side of the right page, on the first page for that date.
- c. The date and weather just to the right of the crew. On all succeeding pages for the same day, only the date need be shown.
- d. Reserve the upper right corner for future numbering.

6-5.03 EXAMPLES OF NOTE FORMS

The ultimate objective of this section is to provide examples of data typically collected in various construction surveys so that any construction surveyor can take any other surveyor's notes and understand them completely. The examples given illustrate historical hand written survey note keeping formats. While construction survey data is no longer recorded as in these examples, they do represent "best practices" approach to collecting construction survey data.

Today, construction survey data is collected through the use of an electronic data collector. The electronic survey data files contain the same information as found in these examples of hand written survey note forms. When electronic data is used rather than paper notes, copies of the original electronic files generated must be saved.

It is recognized that a single format cannot possibly conform to all construction situations. District survey crews should use the electronic format specified by their respective District Survey Supervisor.

6-5.0301 Alignment Notes

Because of rapid changes in electronic file storage, it would be very difficult to list a preferred format in this manual.

6-5.0302 Clearing and Grubbing

See Figure 6-5.0302 for typical clearing and grubbing notes. The notes should conform to the following:

- a. Quantities should be shown on the left page and individual topog and/ or dimensions on the right page.
- b. Individual areas shall be computed to the nearest 0.05 acre. The rounding-off procedure is explained in the Contract Administration Manual (see Section .410, Documentation of Pay Item Quantities, page nine).
- c. When the pay item is by area, the measurements shall be made to a line 10 ft outside the general line of the tree trunks. A dashed line shall designate the tree line and a solid line shall designate the 10 ft line. Computations shall be made to the solid line. See Specification Book, 2101.4A.
- d. The notes become the documentation as required by the Contract Administration Manual and shall be submitted to the project engineer upon completion.

6-5.0303 Muck Excavation

The scaled distance taken from the cross sections should be entered into the notes. See Figure 6-5.0303 for a computation. The scaled elevation of the bottom of the swamp is needed for part of the computation.

6-5.0304 Slope Stakes and Key Stakes

Slopes should be staked to grading grade, i.e. bottom of topsoil. The key stakes information stake can show shoulder point distances either directly from the key stakes or oriented to centerline, at the contractor's option. The information on the stakes shall be the same as the encircled information in the notes (see Figure 6-5.0304A through Figure 6-5.0304C).

6-5.0305 Culverts

It is necessary to take a cross section at the culvert site. A plan and profile sketch should be included in the notes showing the positions of the stakes and the relationship to centerline (see Figure 6-5.0305A and Figure 6-5.0305B).

6-5.0306 Blue Tops

Blue top notes can be either on conventional notepaper or on computer output printout. The computer printout is desirable if a Lenker rod or a total station is used. The turning points and bench mark readings shall be shown. A check mark above each staked elevation serves as documentation that the blue top has been set and the required elevation was actually read on the rod. Do not use the same output paper for restaking. Date and sign each printout.

For a typical example of the Lenker Rod or total station note form, see Figure 6-5.0306.

6-5.0307 Borrow Pits

The notes are usually cross-section, on paper or electronic format, or DTM model, electronic format.

6-5.0308 Storm Sewer

The type of casting should be noted, as this determines the location of the structure in the gutter (see Figure 6-5.0308A and Figure 6-5.0308B).

6-5.0309 Curb and Gutter

The design type should be noted e.g., B624 (see Figure 6-5.0309).

6-5.0310 Paving

The station should be noted at the pluses mentioned in Section 6-3.0209. See Figure 6-5.0310 for an example of paving notes (Lenker Rod).

6-5.0311 Fencing

If the right of way has to be staked for the fencing operation, the monuments should be tied in with reference ties or coordinates. After the fence has been installed, they should be checked (see Figure 6-5.0311).

6-5.0312 Signs

See Figure 6-5.0312.

6-5.0313 Bridge Notes

It is not necessary to keep notes. The documentation of the staking and the check measurements can be entered on the surveyor's copy of sheet 2 of the bridge plan. The date and signature of the crew chief should also be included.

If notes are to be kept, however, the example in Figure 6-5.0313 is a recommended format.

6-5.0314 Bench Levels

See Figure 6-5.0302 for typical construction bench level notes. Every other line is skipped to facilitate correcting errors and/or making adjustments. Temporary bench marks should be tied to centerline (see Figure 6-5.0314).

The offset table shown on the standard acceleration detail sheet is a combination of a 2° 00' 00" curve with a 50:1 taper. The 50:1 taper is with reference to a 22 ft. offset line, and coincides with the forward tangent of the curve. Offsets can be figured for any distance by adding the taper offset (0.02 ft/ft) to the curve's tangent offset (measured from the 50:1 taper) and then increasing this by 22 ft, which (in this case is the width of the mainline shoulder (10 ft) plus the traffic lane width (12 ft)). The tangent offset from the 50:1 taper for 100 ft on the 2° 00' 00" curve is 1.75 ft. Offsets to the curve from the 50:1 taper vary as the square of the distance from the beginning of the curve.

or, (approximately) $Y_c = 1.75 \left[\frac{X}{100} \right]^2$

and, $Y_t = 0.02 X$

Y_c = tangent offset to the curve from the 50:1 taper

Y_t = offset to the 50:1 taper from mainline shoulder

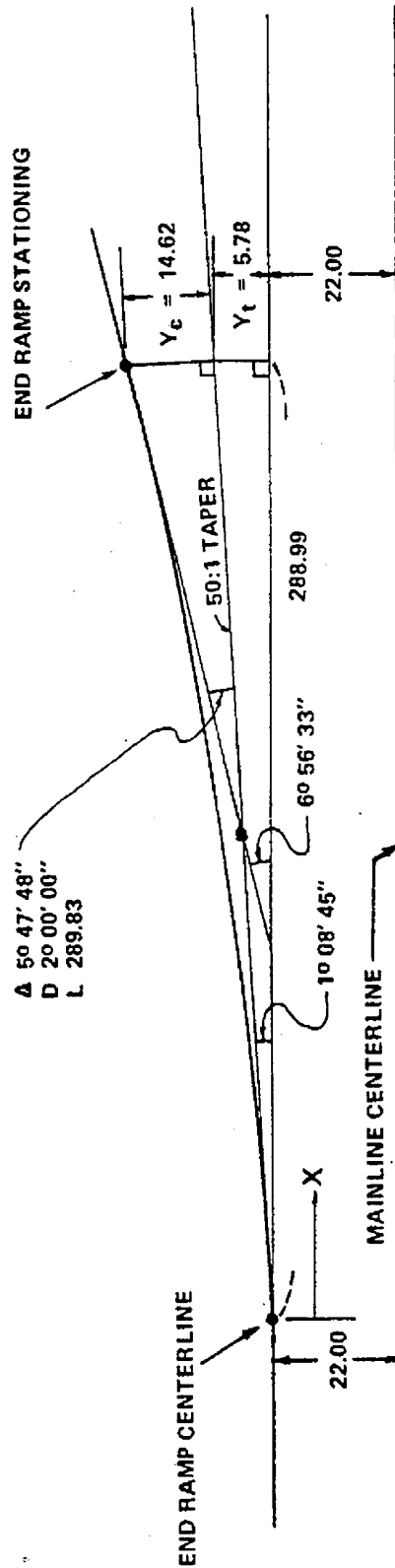

FIGURE 6-2.0203A STANDARD ACCELERATION OFFSETS

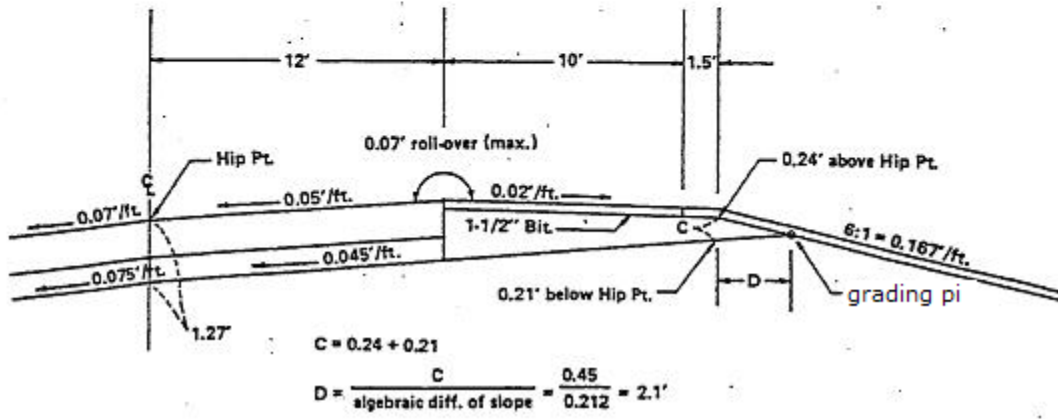
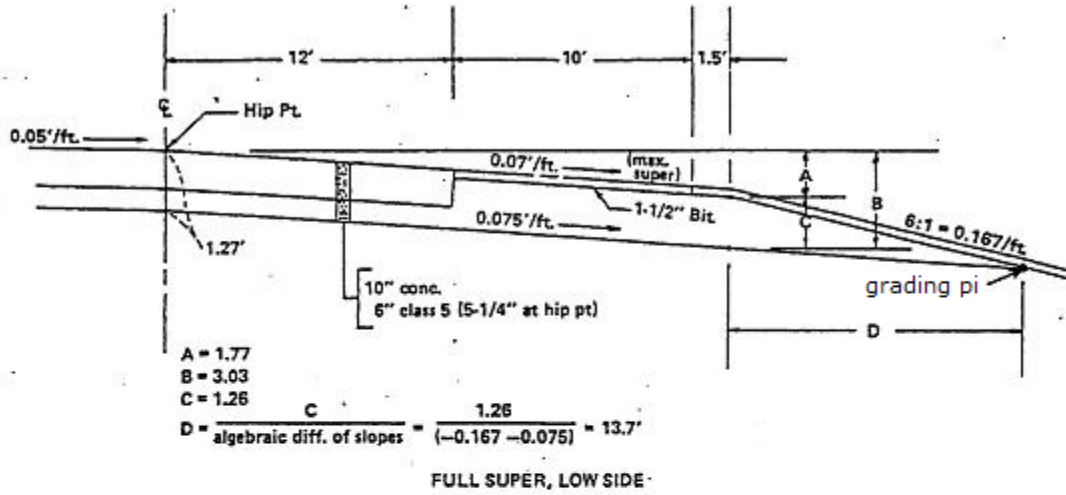

FIGURE 6-2.0203B PIVOT POINT DETAILS

$$X \text{ or } Y = R \tan \frac{\Delta}{2}$$

$$\text{where } \Delta = \tan^{-1} \frac{1}{\text{slope}}$$

EXAMPLE: if R = 32.5 and slope = 3:1

$$\text{then } \Delta = \tan^{-1} \frac{1}{3} = 18^{\circ} 26'$$

$$\text{and } X = 32.5 \cdot \tan 9^{\circ} 13' = 5.3$$

EXAMPLE: if R = 32.5 and slope = 6:1

$$\text{then } \Delta = \Delta_a$$

$$\text{then } \Delta = \tan^{-1} \frac{1}{6} = 9^{\circ} 28'$$

$$\text{and } Y = 32.5 \cdot \tan 4^{\circ} 44' = 2.7$$

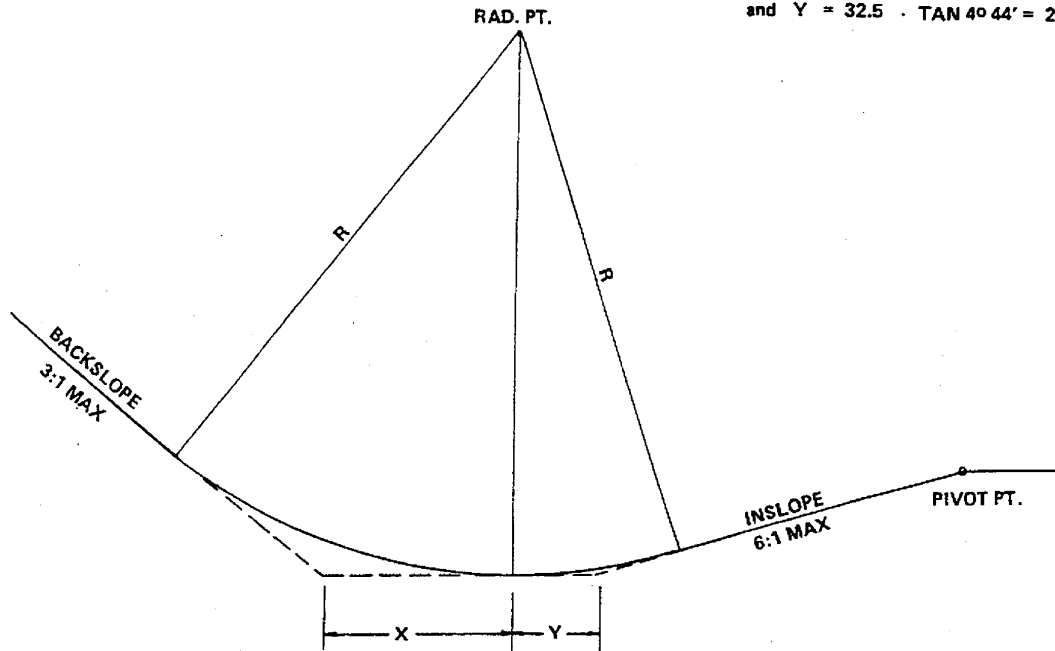

VALUE OF X AND Y FOR VARIOUS SLOPES AND RADII

Slope Ratio	10:1	9:1	8:1	7:1	6:1	5:1	4-1/2:1	4:1	3-1/2:1	3:1	2-1/2:1	2:1	1-1/2:1	1:1
Radius = 1.0	.0499	.0554	.0623	.0711	.0828	.0990	.1098	.1231	.1401	.1623	.1926	.2361	.3028	.4142
= 32.5	1.62	1.80	2.02	2.31	2.69	3.22	3.57	4.00	4.55	5.57	6.26	7.67	9.84	14.46
= 96.7	4.83	5.36	6.02	6.88	8.01	9.57	10.62	11.90	13.55	15.69	18.62	22.83	29.28	40.05

For any radius, multiply by the corresponding value for a 1 ft. radius ditch.

FIGURE 6-2.0203C DITCH BOTTOM WIDTHS

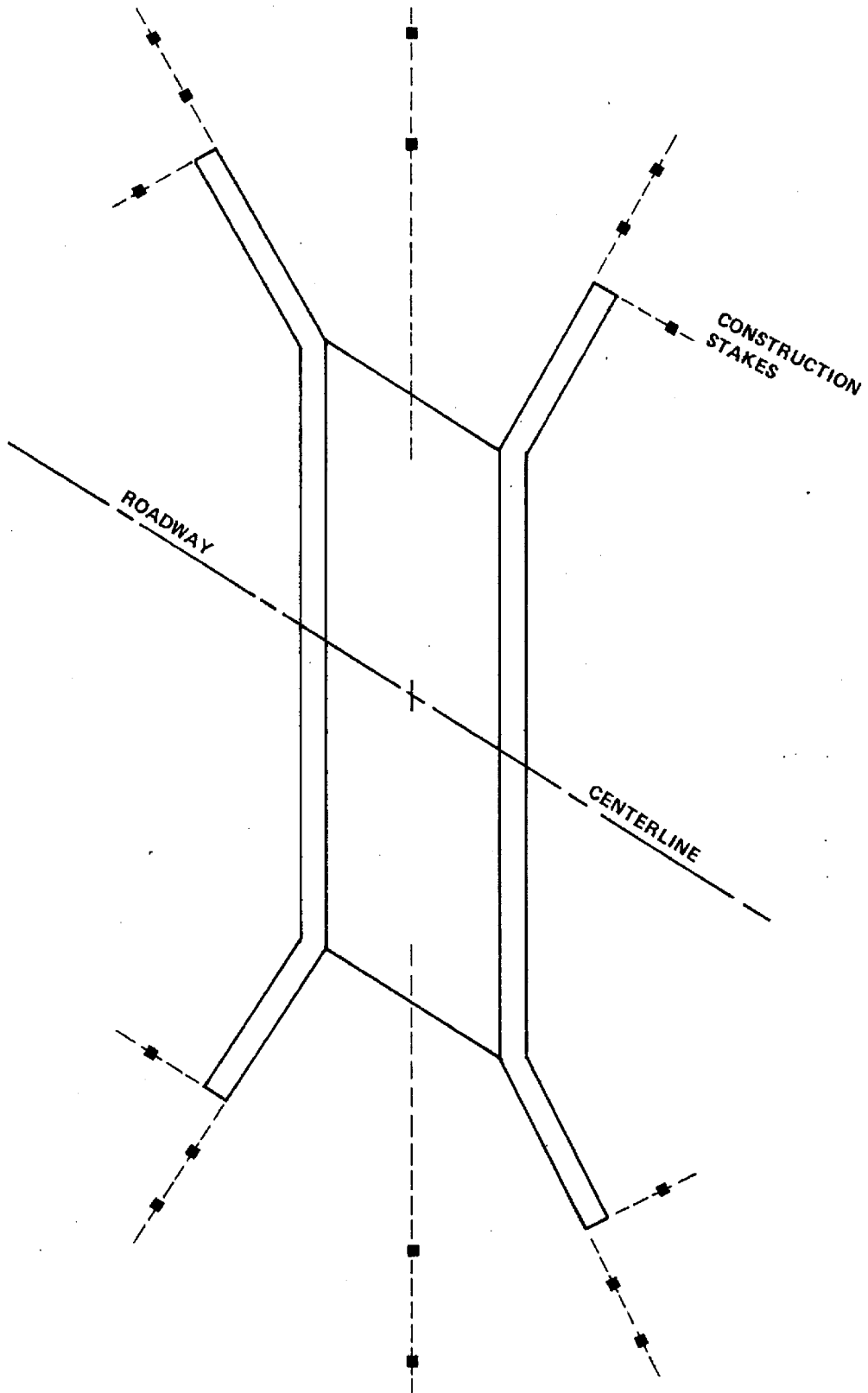

FIGURE 6-2.0205 BOX CULVERT LAYOUT (Plan View)

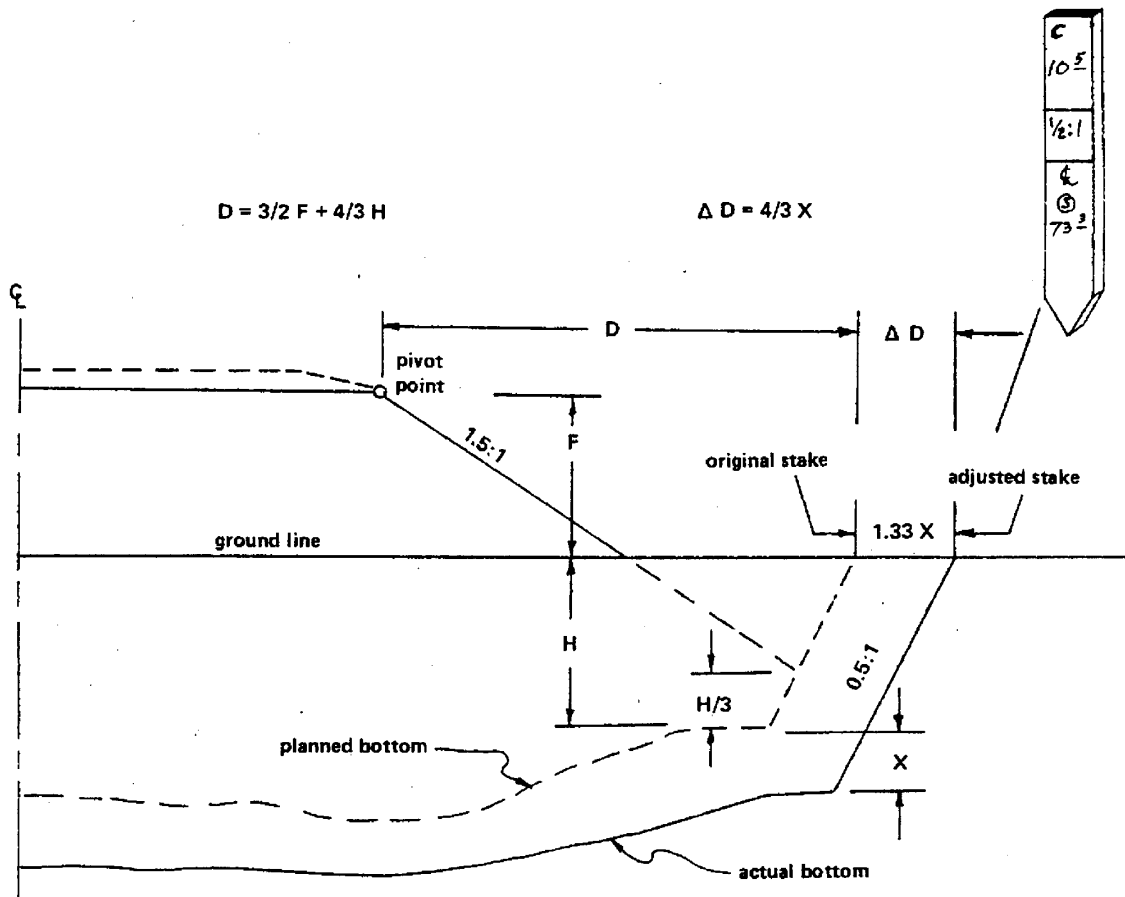
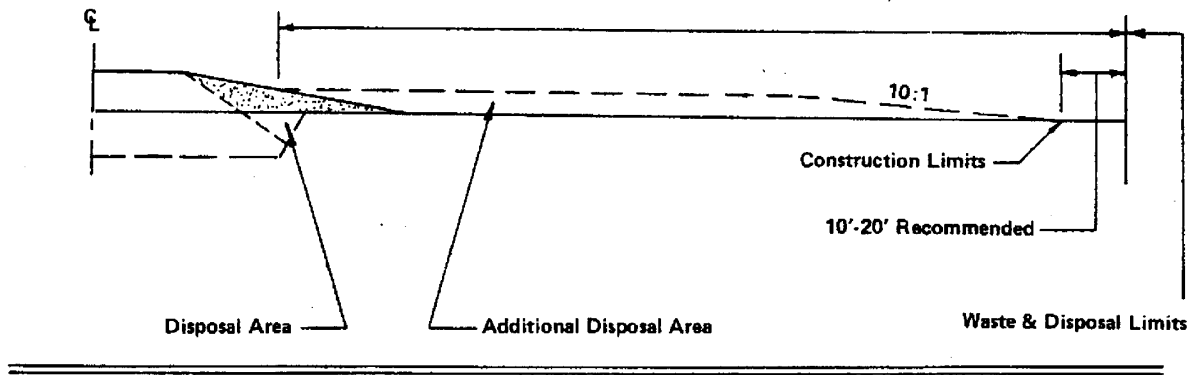

FIGURE 6-3.0202 MUCK EXCAVATION DETAILS

Mn/DOT 28251 (9-78)

WEEKLY SURVEY REPORT

S.P. _____ WEEK ENDING _____ % COMPLETE (OFFICE) _____

AREA _____ JOB _____ ITEM _____ % COMPLETE (FIELD) _____

COUNTY _____ T.H. _____

LOCATION _____

	CREW	HRS		
M O N			WORK AREA:	WEATHER:
			REMARKS:	
			UNIT NO.	SIGNED
T U E			WORK AREA:	WEATHER:
			REMARKS:	
			UNIT NO.	SIGNED
W E D			WORK AREA:	WEATHER:
			REMARKS:	
			UNIT NO.	SIGNED
T H U			WORK AREA:	WEATHER:
			REMARKS:	
			UNIT NO.	SIGNED
F R I			WORK AREA:	WEATHER:
			REMARKS:	
			UNIT NO.	SIGNED

ESTIMATED ADDITIONAL TIME REQUIRED:

FIGURE 6-5.01 WEEKLY SURVEY REPORT FORM

The image shows a title page for survey notes on a binder page. The page is divided into vertical columns by lines. On the left side, there are punch holes and the text "NO. 445" and "P. TELEPHONE" oriented vertically. The handwritten text on the page includes:

S.P. 8282-04
T.H. 94
Contract No. 65432

Slope Stakes

L^{OR} EB 203+10.40 to 262+00

William Jones, Proj. Engr.

June, 1976

TITLE PAGE

FIGURE 6-5.0201 TITLE PAGE FOR SURVEY NOTES

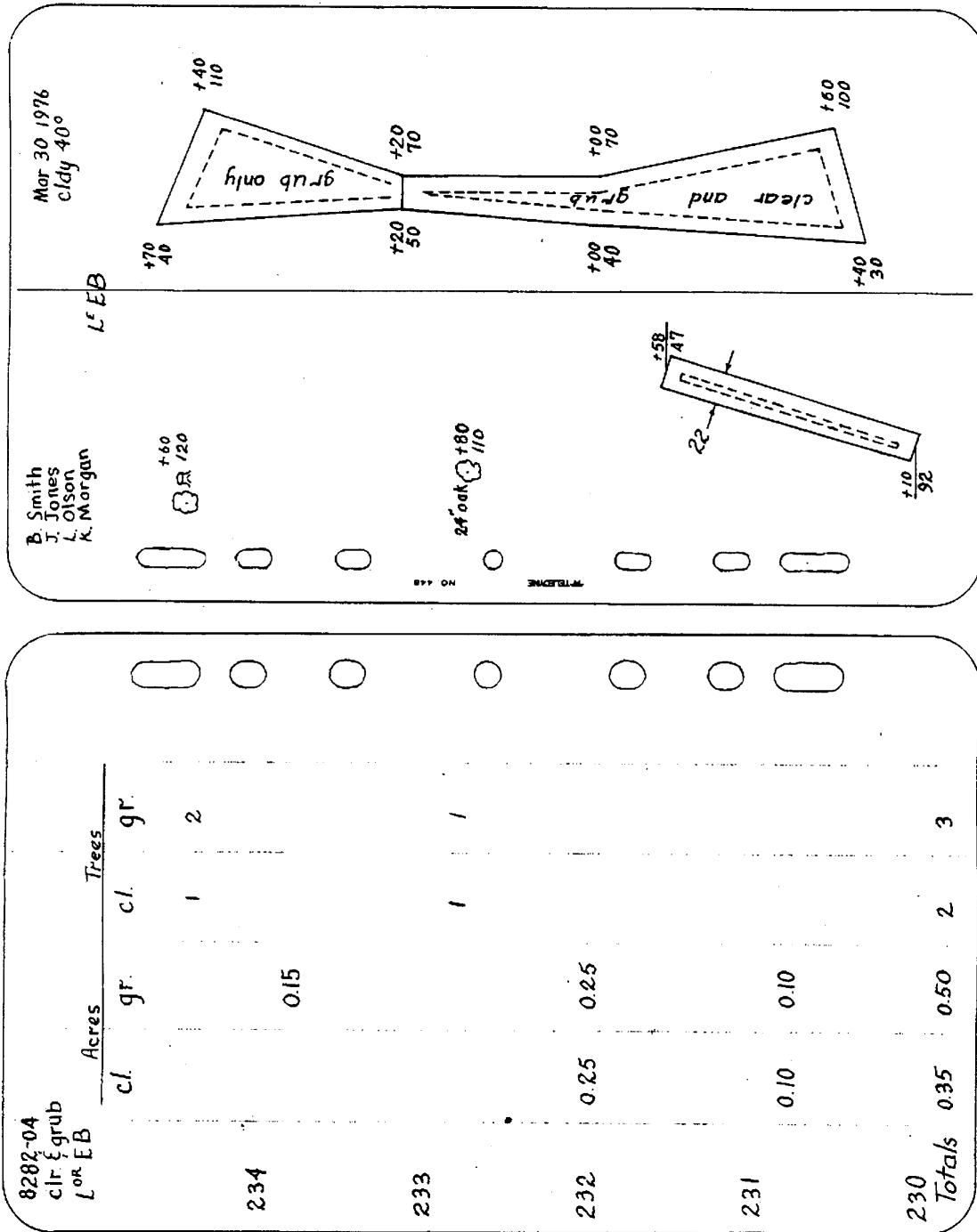

CLEARING AND GRUBBING NOTES

FIGURE 6-5.0302 CLEARING AND GRUBBING NOTES

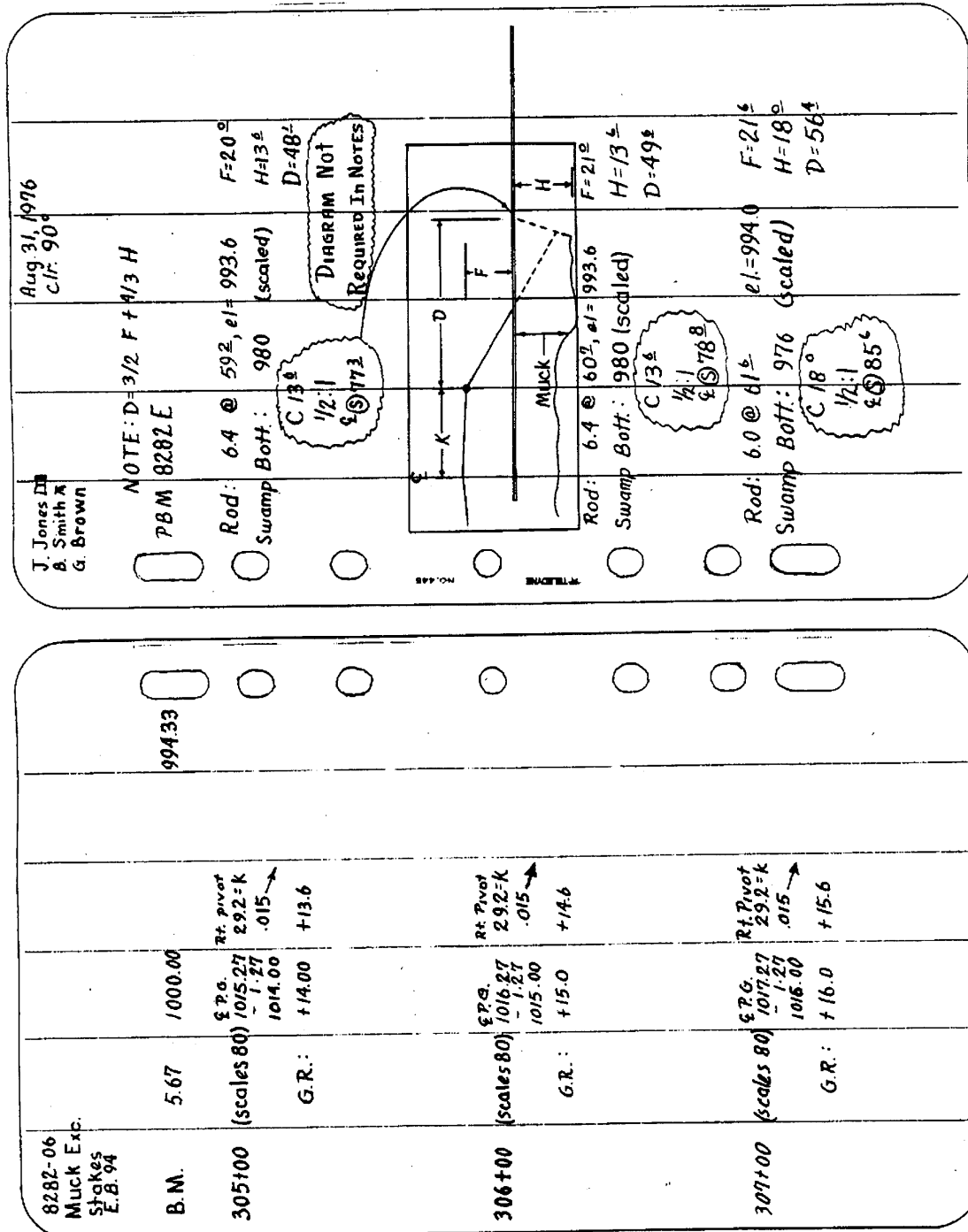
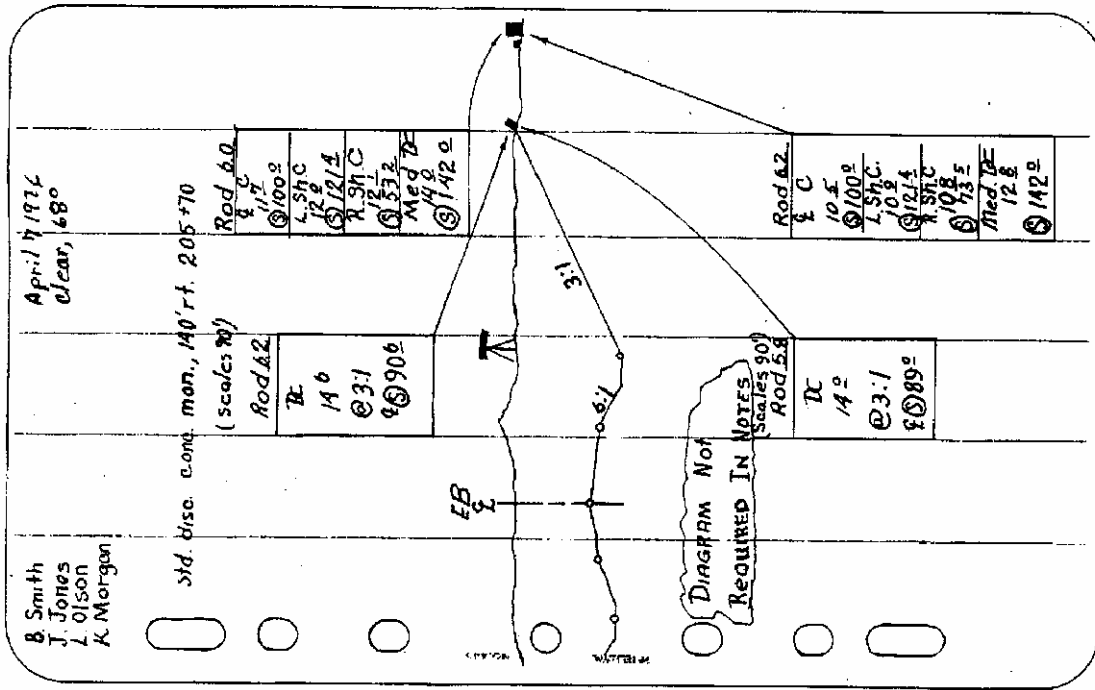

FIGURE 6-5.0303 MUCK EXCAVATION NOTES



8282-04
Slope
Stakes (grading grade)
L OR EB Rt. side only

BM	6.12	995.00	988.88
	med ditch	Lt. gr. pi	Rt. gr. pi
204+00	974.96	976.98	977.30
	GR: 20.0	18.0	17.7
		2.14' Lt.	2.68' Rt.
		-0.15	-0.15
205+00	975.96	977.87	978.30
	GR: 19.0	17.1	16.7
		2.14' Lt.	2.65' Rt.
		-0.02	-0.1
			975.22
			19.8
			47.0' Rt.

SLOPE STAKES
(4 LANE DIVIDED, 1 SIDE ONLY)

FIGURE 6-5.0304A SLOPE STAKES (4 Lane Divided, 1 Side Only)

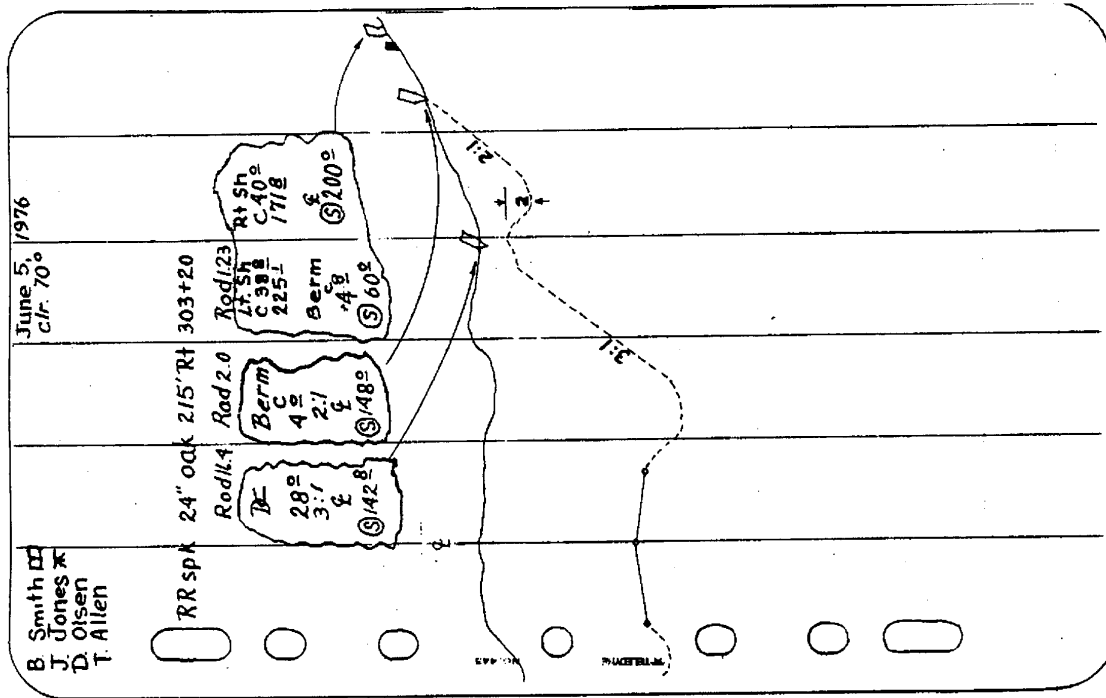

8282-06 Slope Stakes I 94 EBL	Lt Sh	EBL	Rt Sh	D.G.	Berm G
TBM	0.69	989.00			988.31
EB 304+00	.04 GR 40.0	P.G. 949.25 -1.25 948.00 GR 41.0	.01 GR 41.28	945.10 -2.50 942.60 GR 44.4	985.50 -2.50 983.00 GR 6.0
	25.1L	£	28.2R	58.8R	140.0R
Side Shot:	out EL. 24' CMP 125'L 304+60		+6.2	995.0	
305+00					

SLOPE STAKE NOTES, TERRACED SECTION

FIGURE 6-5.0304B SLOPE STAKE NOTES, TERRACED SECTION

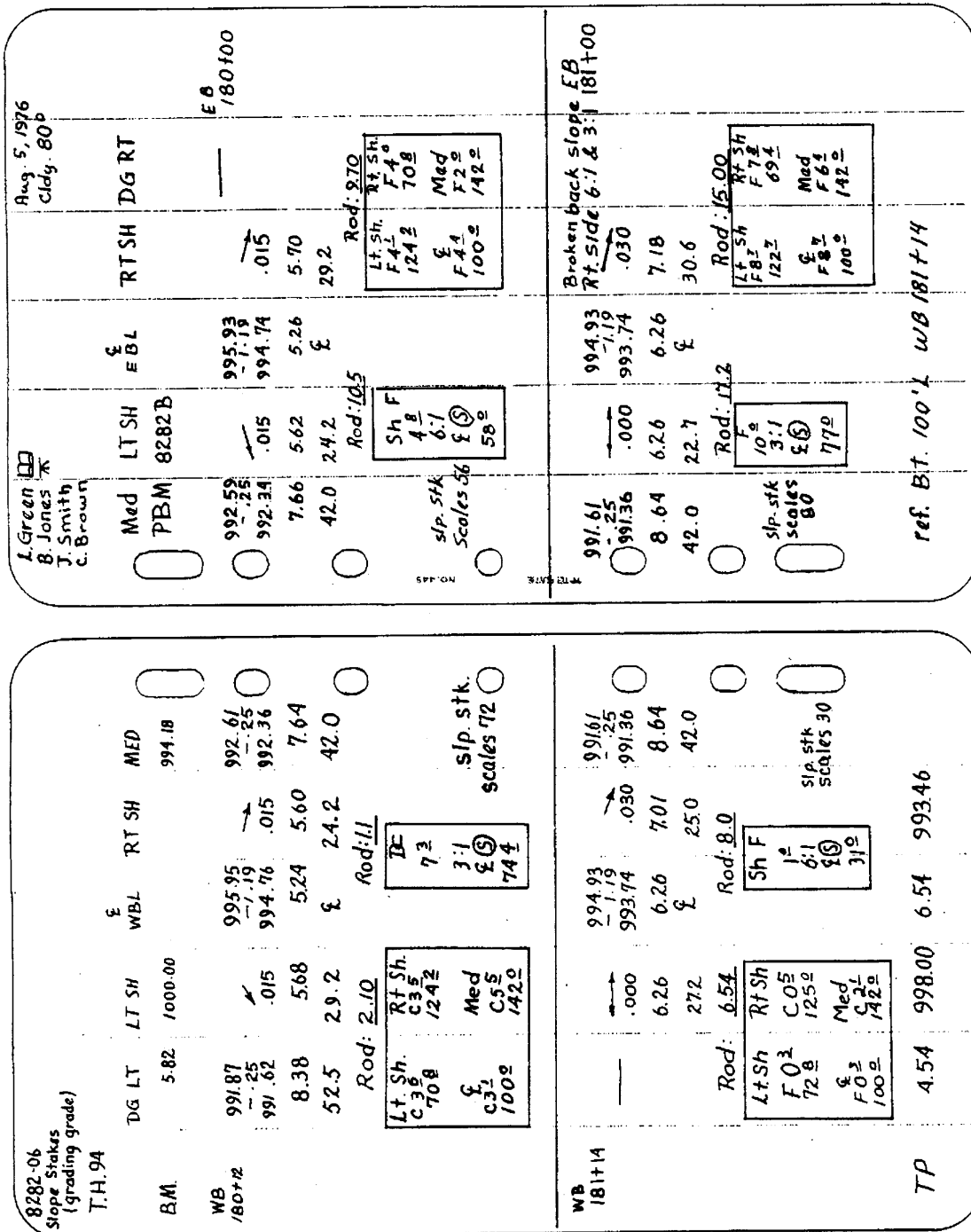

SLOPE STAKES
4 LANE DIVIDED, BOTH SIDES

FIGURE 6-5.0304C SLOPE STAKES (4 Lane Divided, Both Sides)

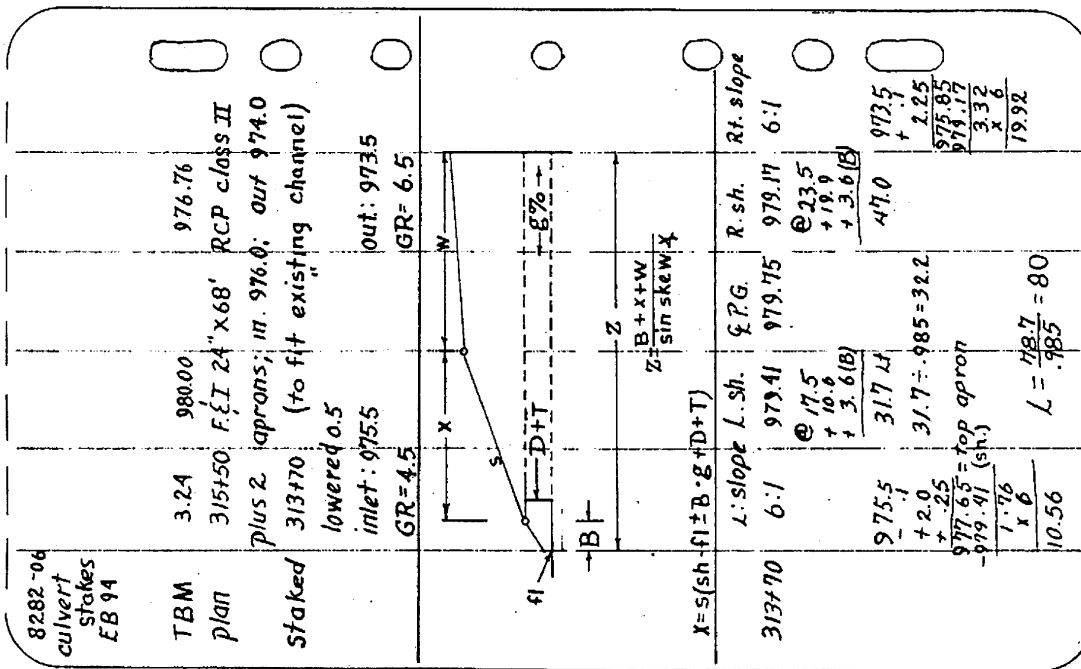
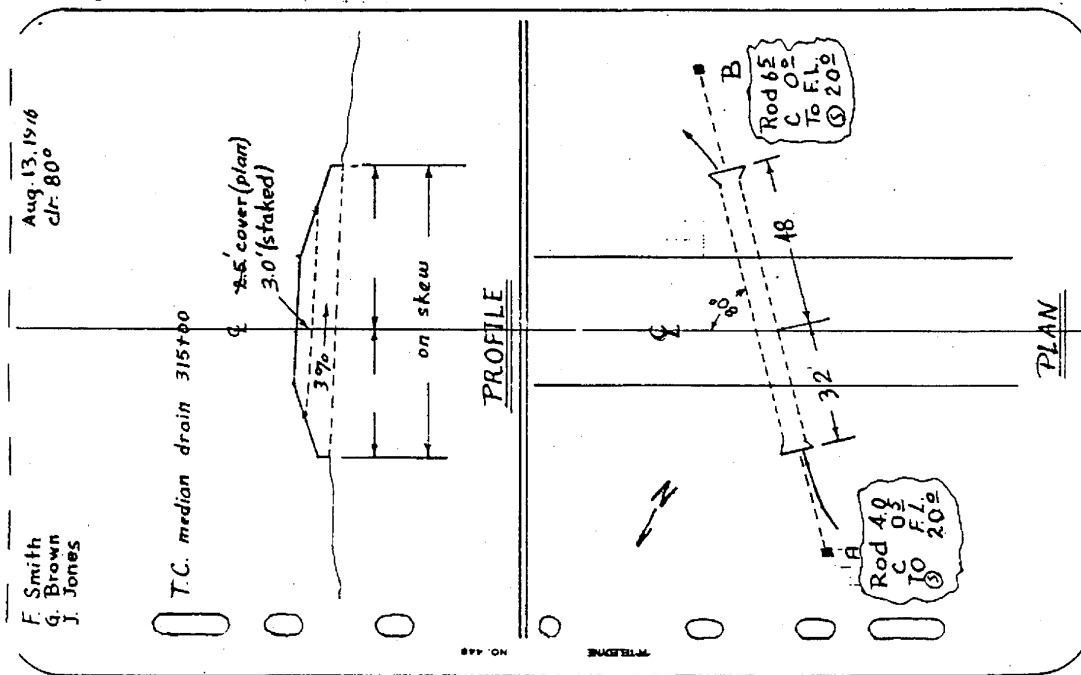

CULVERT NOTES

FIGURE 6-5.0305A CULVERT NOTES

S.C. or C.M. Culvert Staking		Aug. 4, 1976 Party Sunny 80°	
Sta. as shown on plans			
Sta. as staked			
Size			
T.P.			
Cross-section on § of culvert G.R.			
§ Grade		Dimension "c"	
Sh. Elev. Lt.		Inlet Elev.	
Sh. Elev. Rt.		1/2 RDWY WIDTH	
Out. Elev. Rt.		Sh. to top pipe	
Inlet Elev. Lt.		Sh. to top pipe	
Top of pipe Rt.		Less dimension "c"	
Top of pipe Lt.		Use	
Top of BT. Rt.		Total length	
Top of BT. Lt.		Final length	
Elev. at Stake A			
Fl. El. at Stake B			
C to F.L.			
Offset			
J. Jones			
B. Smith			
M. Brown			
P. Malone			

FIGURE 6-5.0305B CULVERT NOTES

8282-06 Grading Blue Tops E.B.L. 94	24-211 E.B.L.	29-2 Rt.	Notes	Aug 3, 1976 city - 80 hrs.	J. Jones B. Smith M. Brown D. Dzieweczynski
B.M.	Set 6.54				
303+00	Read 974.94	974.86			
	Sink 4.94	4.85			
	Grade 4.90	4.84			
+50	74.44	74.36			
	4.44	4.36			
	4.40	4.37			
T.P.	Set 4.36	Read 4.36			
304	.015	74.30			
	3.94	4.30			
	3.90	4.27			
+50	.015	73.80			
	3.44	3.80			
		3.68			
305	.015	73.30			
	2.94	3.30			
	2.90	3.31			
		3.12			
		3.10			

GRADING BLUE TOPS (Lenker Rod)

FIGURE 6-5.0306 GRADING BLUE TOPS (Lenker Rod)

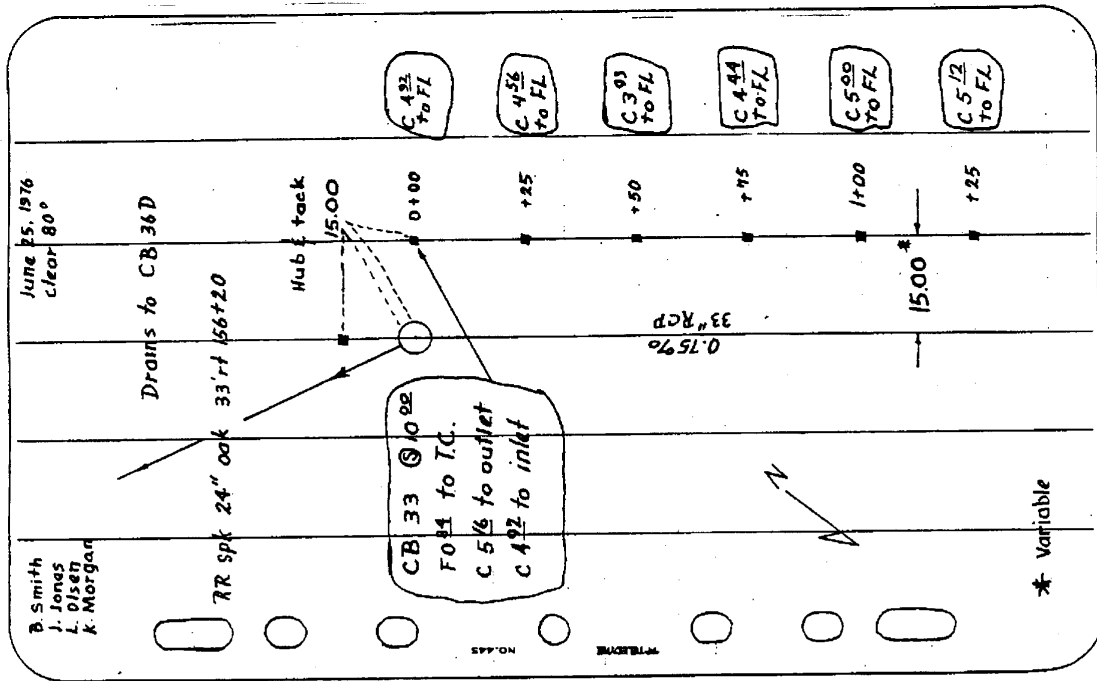

Station	Notes	state Fl. elev.'s	state Fl. elev.'s
BM	8282-06 Storm Sewer E.B.T.H. 12 plan: 86'Rt. Sta. 154+20 Staked: same as plan 3.66 1017.00	1013.34	
0+00	CB 33C T.C. elev. 1011.30	1010.46	outlet = 1005.30 inlet = 1005.54
+25		1010.29	1005.73
+50		1009.85	1005.92
+75		1010.54	1006.10
1+00		1011.29	1006.29
1+25		1011.60	1006.48

SEWER NOTES

FIGURE 6-5.0308A SEWER NOTES

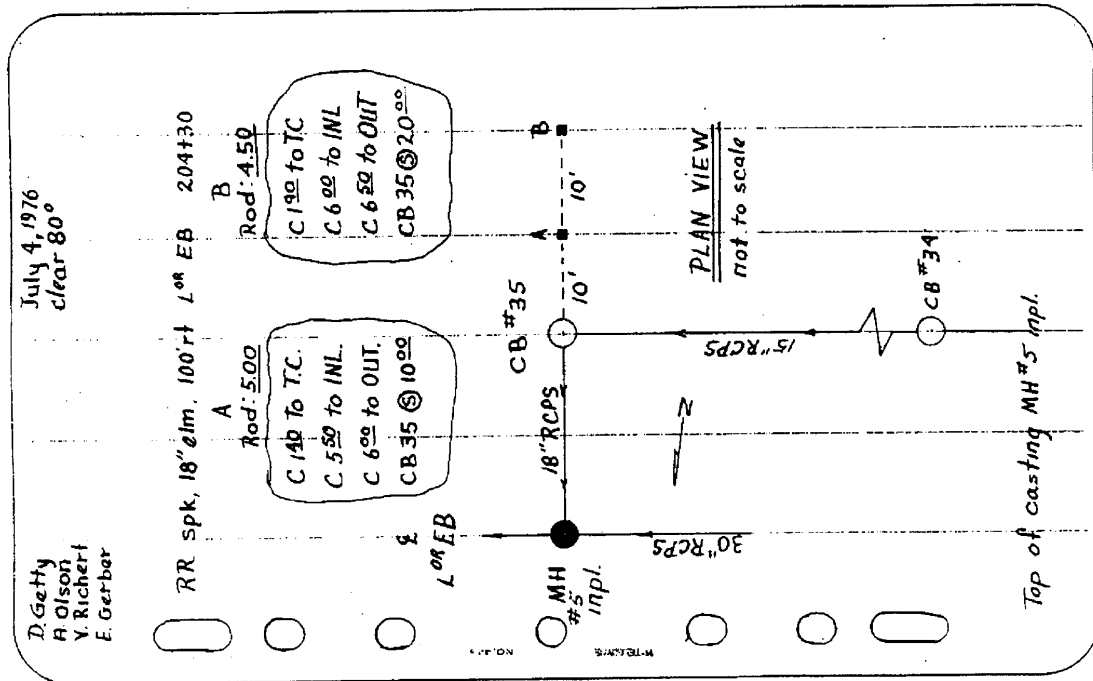

SP8282-04
Storm Sewer
L⁰ EB CB #35

B.M.	5.87	993.00	987.13	
			elev.	G R
204+00	21.00 ft. rt. = CB #35			
	Top of casting elev. =	986.60	6.40	
	inlet FL from West =	982.50	10.50	
	outlet FL to North =	982.00	11.00	

Note: Drains to MH #5 (inpl.)
Inlet from CB #34 (not built yet)

TP 5.75 987.25 987.23

SEWER NOTES

FIGURE 6-5.0308B SEWER NOTES

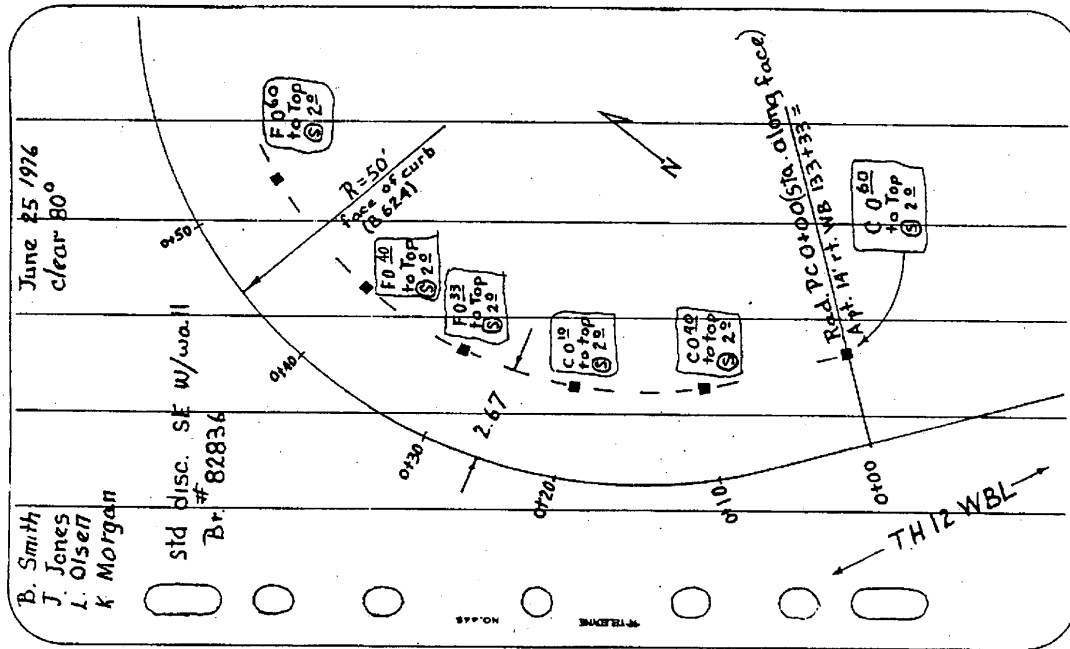

8282-06 curb gutter L or NB	5.70	Note: See grade roll # 38 for grades and panel layout	1046.00	1040.30
BM				
0+00	6.60	Stake elev	1039.40	Top of curb 1038.80
0+10	6.68		1039.32	1038.92
0+20	6.87		1039.13	1039.03
0+30	7.20		1038.80	1039.13
0+40	7.18		1038.82	1039.22
0+50	7.30		1038.70	1039.30

CURB AND GUTTER NOTES

FIGURE 6-5.0309 CURB AND GUTTER NOTES

8282-A Paving Hubs EB 9A		July 14, 1976 cldy 80°	
NOTE: One stake set for line and at grade 2ft. outside form line.		B Smith J. Jones B. Brown O. Czeszynski	
B.M.	set 14' Lt	Pr. Grd.	Read 14' Rt
330+00	1.88	982.00	1.87
+50	2.37	982.50	2.38
331	2.88	983.00	2.88
+50	2.37	983.50	2.37
332	3.88	984.00	3.87
T.P.	Set 0.24		Read 0.22
+50			980.24
333	5.00	985.12	4.99
+50	5.52	985.64	5.51
334	6.02	986.14	6.01

B.M.		Pr. Grd.	Read 14' Rt
330+00	1.88	982.00	1.87
+50	2.37	982.50	2.38
331	2.88	983.00	2.88
+50	2.37	983.50	2.37
332	3.88	984.00	3.87
T.P.	Set 0.24		Read 0.22
+50			980.24
333	5.00	985.12	4.99
+50	5.52	985.64	5.51
334	6.02	986.14	6.01

PAVING HUB NOTES (Lenker Rod)

FIGURE 6-5.0310 PAVING HUB NOTES (Lenker Rod)

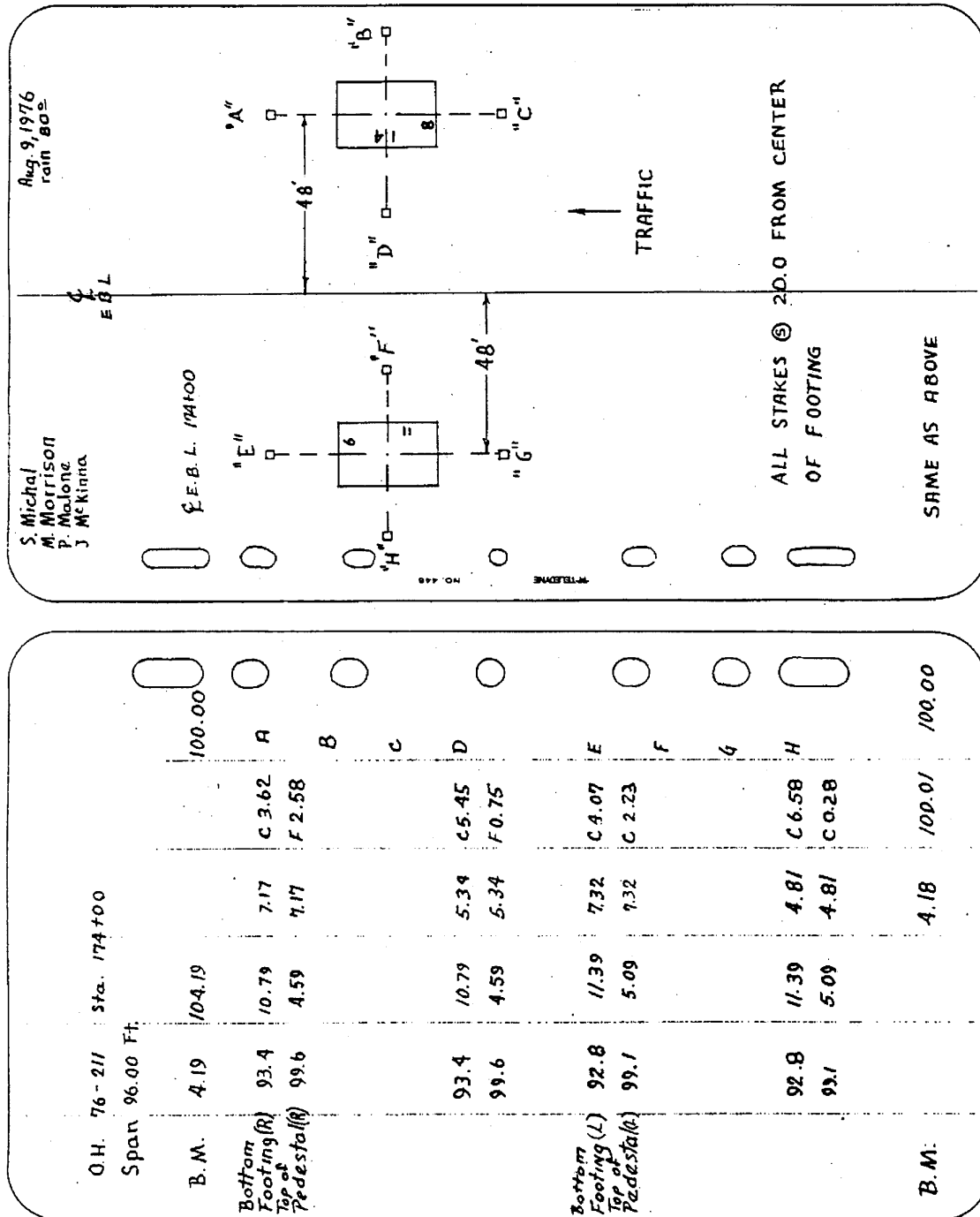

SIGN STAKING NOTES

FIGURE 6-5.0312 SIGN STAKING NOTES

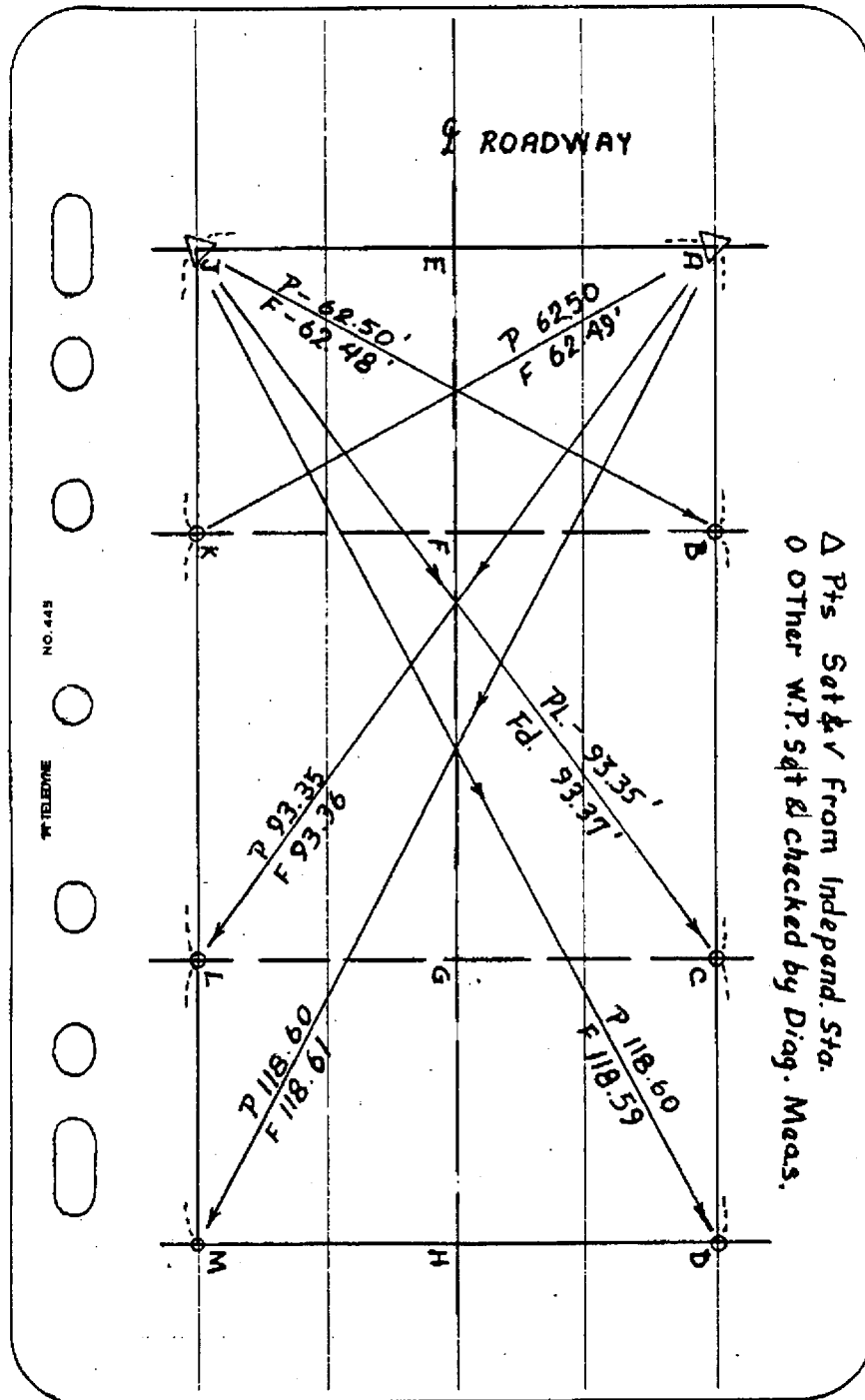

BRIDGE NOTES

FIGURE 6-5.0313 BRIDGE NOTES

ABBREVIATIONS

BBL = BARREL (PIPE)
 B.C. = BACK CURB
 C & G = CURB & GUTTER
 C = CUT
 CAP = CORR. ALUM. PIPE
 C.P. = CENTERLINE
 CL & GR = CLEAR & GRUB
 CMP = CORR. METAL PIPE
 COR = CORNER
 COW = CROWN
 CSP = CORR. STEEL PIPE
 D.E. = DRAINAGE EASEMENT
 D.I. = DROP INLET
 D.O. = DITCH OUT
 E.M. = EDGE BITUMINOUS MAT
 E.S. = EDGE CONCRETE SLAB
 F = FILL
 FF = FRONT FACE
 FL = FLOW LINE
 FL IN = FLOWLINE INLET
 FL OUT = FLOWLINE OUTLET
 GR = GRADE
 GP = GRADING WIDTH

HH = HANDHOLE
 HP = H/P POINT
 LT = LEFT
 MH = MANHOLE
 NB = NORTHBOUND
 NS = NORTH SIDE
 PAR = PARCEL
 P.E. = PERCENT GRADE
 P.F. = PERM. EASEMENT
 RAD = RADIUS POINT
 RCP = REINF. CONC. PIPE
 RP = REFERENCE POINT
 RSC = REINF. SECT. CONC.
 RT = RIGHT
 R/W = RIGHT OF WAY
 S.E. = SLOPE
 SGP = SECT. CONC. PIPE
 SH = SHOULDER
 TC = TOP CASTING
 OR TOP CURB
 T.E. = TEMP. EASEMENT
 3:1 = SLOPE (EXAMPLE)
 WB = WESTBOUND
 WP = WORKING POINTS

STANDARD STAKES

TYPES:
 REFERENCE (REF)
 INFORMATIONAL (INFO)
 VISIBILITY (VIS)
 GUARD (GUARD)

SIZES:
 A = 2" x 2" x VAR. REF./INFO/GUARD
 B = 1" x 2" x VAR. REF./INFO/GUARD
 C = 1" x 2" x LATH INFO/VIS/GUARD
 D = 1/2" x 2" x LATH INFO/VIS/GUARD

STAKING TOLERANCES (FEET)

CONSTRUCTION LIMITS	HORIZONTAL	VERTICAL
CLEARING & GRUBBING	± 1.5	
SLOPES STAKES	2.0	± 0.2
KEY STAKES	0.2	0.03
DRAINAGE STAKES	0.05	0.05
CORB & GUTTER	0.07	0.03
PAVING	0.05	0.03
ALIGNMENT	0.07	
UTILITY	0.10	0.05
STRUCTURAL	0.22	0.02
RAIL	0.5	
BUILDINGS	0.04	
GRA. SIGNS	0.05	0.05
MUCK EXCAVATION LIMITS	2.0	
R/W B-POINTS	0.10	
NOISE WALLS	1.0	0.5

THE TOLERANCES ARE RELATIVE TO PROJECT DATUM

DISCLAIMER

THESE STAKING INFORMATION SHEETS ARE FOR INFORMATION PURPOSES ONLY. STAKING PROCEDURES VARY AND MAY BE SUBJECT TO CHANGE DURING CONSTRUCTION BY CIRCUMSTANCES AND/OR AGREEMENTS BETWEEN SURVEY CREW AND CONTRACTOR.

RECOMMENDED STAKING INTERVALS

STAKE TYPE	GLASS	CONC.	WOOD	OR	BACK	R/W	FLIP
1/2" x 2" x 2"	100	50	50	100	100	ALL CORNERS	ALL CORNERS
1" x 2" x 2"	100	50	50	100	100	ALL CORNERS	ALL CORNERS
1/2" x 2" x 2"	100	50	50	100	100	ALL CORNERS	ALL CORNERS
1" x 2" x 2"	100	50	50	100	100	ALL CORNERS	ALL CORNERS
1/2" x 2" x 2"	100	50	50	100	100	ALL CORNERS	ALL CORNERS
1" x 2" x 2"	100	50	50	100	100	ALL CORNERS	ALL CORNERS
1/2" x 2" x 2"	100	50	50	100	100	ALL CORNERS	ALL CORNERS
1" x 2" x 2"	100	50	50	100	100	ALL CORNERS	ALL CORNERS
1/2" x 2" x 2"	100	50	50	100	100	ALL CORNERS	ALL CORNERS
1" x 2" x 2"	100	50	50	100	100	ALL CORNERS	ALL CORNERS
1/2" x 2" x 2"	100	50	50	100	100	ALL CORNERS	ALL CORNERS
1" x 2" x 2"	100	50	50	100	100	ALL CORNERS	ALL CORNERS
1/2" x 2" x 2"	100	50	50	100	100	ALL CORNERS	ALL CORNERS
1" x 2" x 2"	100	50	50	100	100	ALL CORNERS	ALL CORNERS
1/2" x 2" x 2"	100	50	50	100	100	ALL CORNERS	ALL CORNERS
1" x 2" x 2"	100	50	50	100	100	ALL CORNERS	ALL CORNERS
1/2" x 2" x 2"	100	50	50	100	100	ALL CORNERS	ALL CORNERS
1" x 2" x 2"	100	50	50	100	100	ALL CORNERS	ALL CORNERS
1/2" x 2" x 2"	100	50	50	100	100	ALL CORNERS	ALL CORNERS
1" x 2" x 2"	100	50	50	100	100	ALL CORNERS	ALL CORNERS
1/2" x 2" x 2"	100	50	50	100	100	ALL CORNERS	ALL CORNERS
1" x 2" x 2"	100	50	50	100	100	ALL CORNERS	ALL CORNERS
1/2" x 2" x 2"	100	50	50	100	100	ALL CORNERS	ALL CORNERS
1" x 2" x 2"	100	50	50	100	100	ALL CORNERS	ALL CORNERS
1/2" x 2" x 2"	100	50	50	100	100	ALL CORNERS	ALL CORNERS
1" x 2" x 2"	100	50	50	100	100	ALL CORNERS	ALL CORNERS
1/2" x 2" x 2"	100	50	50	100	100	ALL CORNERS	ALL CORNERS
1" x 2" x 2"	100	50	50	100	100	ALL CORNERS	ALL CORNERS
1/2" x 2" x 2"	100	50	50	100	100	ALL CORNERS	ALL CORNERS
1" x 2" x 2"	100	50	50	100	100	ALL CORNERS	ALL CORNERS
1/2" x 2" x 2"	100	50	50	100	100	ALL CORNERS	ALL CORNERS
1" x 2" x 2"	100	50	50	100	100	ALL CORNERS	ALL CORNERS
1/2" x 2" x 2"	100	50	50	100	100	ALL CORNERS	ALL CORNERS
1" x 2" x 2"	100	50	50	100	100	ALL CORNERS	ALL CORNERS
1/2" x 2" x 2"	100	50	50	100	100	ALL CORNERS	ALL CORNERS
1" x 2" x 2"	100	50	50	100	100	ALL CORNERS	ALL CORNERS
1/2" x 2" x 2"	100	50	50	100	100	ALL CORNERS	ALL CORNERS
1" x 2" x 2"	100	50	50	100	100	ALL CORNERS	ALL CORNERS
1/2" x 2" x 2"	100	50	50	100	100	ALL CORNERS	ALL CORNERS
1" x 2" x 2"	100	50	50	100	100	ALL CORNERS	ALL CORNERS
1/2" x 2" x 2"	100	50	50	100	100	ALL CORNERS	ALL CORNERS
1" x 2" x 2"	100	50	50	100	100	ALL CORNERS	ALL CORNERS
1/2" x 2" x 2"	100	50	50	100	100	ALL CORNERS	ALL CORNERS
1" x 2" x 2"	100	50	50	100	100	ALL CORNERS	ALL CORNERS
1/2" x 2" x 2"	100	50	50	100	100	ALL CORNERS	ALL CORNERS
1" x 2" x 2"	100	50	50	100	100	ALL CORNERS	ALL CORNERS
1/2" x 2" x 2"	100	50	50	100	100	ALL CORNERS	ALL CORNERS
1" x 2" x 2"	100	50	50	100	100	ALL CORNERS	ALL CORNERS
1/2" x 2" x 2"	100	50	50	100	100	ALL CORNERS	ALL CORNERS
1" x 2" x 2"	100	50	50	100	100	ALL CORNERS	ALL CORNERS
1/2" x 2" x 2"	100	50	50	100	100	ALL CORNERS	ALL CORNERS
1" x 2" x 2"	100	50	50	100	100	ALL CORNERS	ALL CORNERS
1/2" x 2" x 2"	100	50	50	100	100	ALL CORNERS	ALL CORNERS
1" x 2" x 2"	100	50	50	100	100	ALL CORNERS	ALL CORNERS
1/2" x 2" x 2"	100	50	50	100	100	ALL CORNERS	ALL CORNERS
1" x 2" x 2"	100	50	50	100	100	ALL CORNERS	ALL CORNERS
1/2" x 2" x 2"	100	50	50	100	100	ALL CORNERS	ALL CORNERS
1" x 2" x 2"	100	50	50	100	100	ALL CORNERS	ALL CORNERS
1/2" x 2" x 2"	100	50	50	100	100	ALL CORNERS	ALL CORNERS
1" x 2" x 2"	100	50	50	100	100	ALL CORNERS	ALL CORNERS
1/2" x 2" x 2"	100	50	50	100	100	ALL CORNERS	ALL CORNERS
1" x 2" x 2"	100	50	50	100	100	ALL CORNERS	ALL CORNERS
1/2" x 2" x 2"	100	50	50	100	100	ALL CORNERS	ALL CORNERS
1" x 2" x 2"	100	50	50	100	100	ALL CORNERS	ALL CORNERS
1/2" x 2" x 2"	100	50	50	100	100	ALL CORNERS	ALL CORNERS
1" x 2" x 2"	100	50	50	100	100	ALL CORNERS	ALL CORNERS
1/2" x 2" x 2"	100	50	50	100	100	ALL CORNERS	ALL CORNERS
1" x 2" x 2"	100	50	50	100	100	ALL CORNERS	ALL CORNERS
1/2" x 2" x 2"	100	50	50	100	100	ALL CORNERS	ALL CORNERS
1" x 2" x 2"	100	50	50	100	100	ALL CORNERS	ALL CORNERS
1/2" x 2" x 2"	100	50	50	100	100	ALL CORNERS	ALL CORNERS
1" x 2" x 2"	100	50	50	100	100	ALL CORNERS	ALL CORNERS
1/2" x 2" x 2"	100	50	50	100	100	ALL CORNERS	ALL CORNERS
1" x 2" x 2"	100	50	50	100	100	ALL CORNERS	ALL CORNERS
1/2" x 2" x 2"	100	50	50	100	100	ALL CORNERS	ALL CORNERS
1" x 2" x 2"	100	50	50	100	100	ALL CORNERS	ALL CORNERS
1/2" x 2" x 2"	100	50	50	100	100	ALL CORNERS	ALL CORNERS
1" x 2" x 2"	100	50	50	100	100	ALL CORNERS	ALL CORNERS
1/2" x 2" x 2"	100	50	50	100	100	ALL CORNERS	ALL CORNERS
1" x 2" x 2"	100	50	50	100	100	ALL CORNERS	ALL CORNERS
1/2" x 2" x 2"	100	50	50	100	100	ALL CORNERS	ALL CORNERS
1" x 2" x 2"	100	50	50	100	100	ALL CORNERS	ALL CORNERS
1/2" x 2" x 2"	100	50	50	100	100	ALL CORNERS	ALL CORNERS
1" x 2" x 2"	100	50	50	100	100	ALL CORNERS	ALL CORNERS
1/2" x 2" x 2"	100	50	50	100	100	ALL CORNERS	ALL CORNERS
1" x 2" x 2"	100	50	50	100	100	ALL CORNERS	ALL CORNERS
1/2" x 2" x 2"	100	50	50	100	100	ALL CORNERS	ALL CORNERS
1" x 2" x 2"	100	50	50	100	100	ALL CORNERS	ALL CORNERS
1/2" x 2" x 2"	100	50	50	100	100	ALL CORNERS	ALL CORNERS
1" x 2" x 2"	100	50	50	100	100	ALL CORNERS	ALL CORNERS
1/2" x 2" x 2"	100	50	50	100	100	ALL CORNERS	ALL CORNERS
1" x 2" x 2"	100	50	50	100	100	ALL CORNERS	ALL CORNERS
1/2" x 2" x 2"	100	50	50	100	100	ALL CORNERS	ALL CORNERS
1" x 2" x 2"	100	50	50	100	100	ALL CORNERS	ALL CORNERS
1/2" x 2" x 2"	100	50	50	100	100	ALL CORNERS	ALL CORNERS
1" x 2" x 2"	100	50	50	100	100	ALL CORNERS	ALL CORNERS
1/2" x 2" x 2"	100	50	50	100	100	ALL CORNERS	ALL CORNERS
1" x 2" x 2"	100	50	50	100	100	ALL CORNERS	ALL CORNERS
1/2" x 2" x 2"	100	50	50	100	100	ALL CORNERS	ALL CORNERS
1" x 2" x 2"	100	50	50	100	100	ALL CORNERS	ALL CORNERS
1/2" x 2" x 2"	100	50	50	100	100	ALL CORNERS	ALL CORNERS
1" x 2" x 2"	100	50	50	100	100	ALL CORNERS	ALL CORNERS
1/2" x 2" x 2"	100	50	50	100	100	ALL CORNERS	ALL CORNERS
1" x 2" x 2"	100	50	50	100	100	ALL CORNERS	ALL CORNERS
1/2" x 2" x 2"	100	50	50	100	100	ALL CORNERS	ALL CORNERS
1" x 2" x 2"	100	50	50	100	100	ALL CORNERS	ALL CORNERS
1/2" x 2" x 2"	100	50	50	100	100	ALL CORNERS	ALL CORNERS
1" x 2" x 2"	100	50	50	100	100	ALL CORNERS	ALL CORNERS
1/2" x 2" x 2"	100	50	50	100	100	ALL CORNERS	ALL CORNERS
1" x 2" x 2"	100	50	50	100	100	ALL CORNERS	ALL CORNERS
1/2" x 2" x 2"	100	50	50	100	100	ALL CORNERS	ALL CORNERS
1" x 2" x 2"	100	50	50	100	100	ALL CORNERS	ALL CORNERS
1/2" x 2" x 2"	100	50	50	100	100	ALL CORNERS	ALL CORNERS
1" x 2" x 2"	100	50	50	100	100	ALL CORNERS	ALL CORNERS
1/2" x 2" x 2"	100	50	50	100	100	ALL CORNERS	ALL CORNERS
1" x 2" x 2"	100	50	50	100	100	ALL CORNERS	ALL CORNERS
1/2" x 2" x 2"	100	50	50	100	100	ALL CORNERS	ALL CORNERS
1" x 2" x 2"	100	50	50	100	100	ALL CORNERS	ALL CORNERS
1/2" x 2" x 2"	100	50	50	100	100	ALL CORNERS	ALL CORNERS
1" x 2" x 2"	100	50	50	100	100	ALL CORNERS	ALL CORNERS
1/2" x 2" x 2"	100	50	50	100	100	ALL CORNERS	ALL CORNERS
1" x 2" x 2"	100	50	50	100	100	ALL CORNERS	ALL CORNERS
1/2" x 2" x 2"	100	50	50	100	100	ALL CORNERS	ALL CORNERS
1" x 2" x 2"	100						

GUARRAIL (GUARD)

BUILDING (BUILD) FOUNDATION / FOOTING

ALIGNMENT POINTS (ALIGN)

STAKE C - THIS TYPE STAKE MAY BE USED AS TEMPORARY STAKE. IT MAY BE REPLACED BY WOOD MARKER AFTER CONSTRUCTION IS COMPLETED.
 SET AT GROUND LEVEL. TEMPORARY CONSTRUCTION STAKE I.
 FACE SET AT ALIGNMENT POINTS.
 STAKE A - STAKE SET AT THIS STATIONING BEING USED FOR STATIONING OF STATION.

R/W & TEMP. EASEMENT (R/W)

CLEAR & GRUBBING LIMITS (CLEAR) OR MUCK EXCAVATION LIMITS (MUCK)

NOTE: FRONT OF LATH GOES TOWARD E

OVERHEAD SIGNS (SIGN)

BRIDGESTAKING (BRIDGE) WORKING POINTS LAYOUT

WALL

STAKES MAY BE PLACED ON EITHER SIDE OF THE WALL

CULVERT

STANDARD SHEET NO. 5-297.115 (2 OF 2)
 STAKING APPROVED: DECEMBER 21, 1994
 STATE PROJ. NO. _____ SHEET NO. _____ OF _____ SHEETS

TITLE: STAKING INFORMATION SHEET

**CHAPTER 7 - PROCUREMENT, MANAGEMENT
AND MAINTENANCE OF EQUIPMENT****7-1 BUDGET AND PURCHASE**

7-1.01 INTRODUCTION

7-1.02 BUDGET REQUEST

7-1.03 REQUISITION FOR PURCHASE (OMITTED)

7-1.04 PURCHASE ORDER

7-2 SURVEYING AND MAPPING EQUIPMENT

7-2.01 INTRODUCTION

7-2.02 FIXED ASSET (CODED) EQUIPMENT

7-2.03 NON-CODED EQUIPMENT

7-2.04 EQUIPMENT EVALUATION

7-2.0401 Equipment Specifications

7-2.0402 Evaluation Report Form

7-2.0403 Product/Service Problem

7-3 EQUIPMENT MANAGEMENT7-3.01 DISTRIBUTION AND ASSIGNMENT OF SURVEY
EQUIPMENT7-3.02 TRANSFER, TRADE-IN, OBSOLETE, JUNKED OR
SURPLUS FIXED ASSET EQUIPMENT

7-3.03 STOLEN, LOST OR DAMAGED EQUIPMENT

7-3.04 INVENTORY

7-4 EQUIPMENT AND MAINTENANCE

7-4.01 FIELD CARE AND ADJUSTMENT

7-4.02 SERVICING AND REPAIRS

CHAPTER 7 - PROCUREMENT, MANAGEMENT AND MAINTENANCE OF EQUIPMENT

7-1 BUDGET AND PURCHASE

7-1.01 INTRODUCTION

The Minnesota Department of Transportation along with other state departments purchases equipment from funds appropriated by the state legislature. The Department submits a two-year budget request to the legislature for consideration of funding approval for the next biennium (July 1 of odd numbered years).

Included in the budget request by Mn/DOT are funds for new, additional, and replacement scientific survey equipment. This budget is administered by the statewide Survey Scientific Equipment Committee for statewide survey needs.

After legislative action (funding authorization), the appropriated funds for the survey scientific equipment are available through the Mn/DOT Program Support Group for purchase of equipment budgeted.

7-1.02 BUDGET REQUEST

Budget requests and requisitions for purchase of surveying and mapping equipment are processed through the Office of Land Management, Central Office. The amount that is budgeted for this equipment each fiscal year is determined by the following schedule:

- a. At the beginning of a new biennium, available funding levels are announced for the two fiscal years of that biennium. The District Surveys Engineers/Land Surveyors, along with the Central Office Surveying and Mapping Section, Geodetic, Automation, and Photogrammetric Engineers/Land Surveyors are asked to prepare an itemized listing of their estimated needs for new, additional, and replacement survey equipment, as well as a dollar amount for miscellaneous survey equipment.
- b. All District and Surveying & Mapping Section equipment requests are submitted to the Chairperson of the Survey Scientific Equipment Committee for consolidation. The Statewide Survey Scientific Equipment Committee then prioritizes equipment requests, removing lower priority items in order to meet the level of available funding. At this time the committee gives preliminary approval to the budget draft.
- c. This request is then submitted for final review and approval by the Director of Surveying and Mapping in the Office of Land Management.

7-1.03 REQUISITION FOR PURCHASE (OMITTED)

7-1.04 PURCHASE ORDER

The requisition for purchase is submitted to the Materials Management Division, Department of Administration and assigned to a Purchasing Agent for bid scheduling.

At the time and date specified for closing, the bids received in the Materials Management Division are opened and recorded. The bids are evaluated for compliance with the bid and specifications, and the bid is awarded by issuing a purchase order to the low bidder meeting the bid's requirements.

If there is a question of determining which items (low bid) meet specifications, the Materials Management Division Purchasing Agent will contact the initiator of the request to review the bid and make recommendations. In the case of surveying equipment, the Survey Scientific Equipment Committee Chairperson is notified in order to review the bids and make recommendations.

7-2 SURVEYING AND MAPPING EQUIPMENT

7-2.01 INTRODUCTION

Surveying and mapping equipment is generally classified into two categories for purchase and inventory purposes.

- a. Fixed Asset (coded) equipment, i.e. surveying instruments, etc. which are considered non-expendable equipment.
- b. Non-coded equipment, i.e. tripods, tribrachs, rods, etc. which are considered expendable equipment.

Before purchasing new surveying and mapping equipment of a type and model new to Mn/DOT, an evaluation or testing period is made to provide a means of determining what new equipment on the market meets Mn/DOT's specifications.

7-2.02 FIXED ASSET (CODED) EQUIPMENT

All coded, non-expendable, surveying and mapping equipment is included in the State's Fixed Assets Inventory. Upon delivery of any new equipment, each instrument is assigned and marked with a fixed assets code number for inventory control. The code number stays with the item until it is declared surplus for trade, sold, or junked.

Following is a partial listing of coded surveying and mapping equipment:

FIELD EQUIPMENT

Global Position System (GPS)	Gasoline or Electric Powered Drill & Driver
Total Station	Stereoplotter
Level (Engineers)	"Field" Computers

7-2.03 NON-CODED EQUIPMENT (ITEMS VALUED AT LESS THAN \$2000)

Non-coded surveying and mapping equipment is not entered into the State's Fixed Assets Inventory. This equipment consists of generally expendable items that wear out over a relatively short period of time.

Following is a partial listing of non-coded equipment used in surveying and mapping:

Field Equipment

Tripod Retro	Directive Prism
Rod, Leveling	Plumbing Pole
Tribrach, T-2 Type	

7-2.04 EQUIPMENT EVALUATION

The Survey Scientific Equipment Committee Chairperson is responsible for the requisition and final acceptance of new surveying equipment purchased for Mn/DOT. This responsibility includes the scheduling of testing new makes and models provided by the vendor or company for evaluation.

7-2.0401 Equipment Specifications

When ordering new equipment the Survey Scientific Committee Chairperson will submit one to three recommended makes and models, based upon previous evaluations, to the purchasing agent. It is the responsibility of competing bidders to research the requested make and model in order to determine the product's specifications. If a competing vendor believes they have a product that meets or exceeds the specifications of the recommended make and model, they may enter a bid and, if successful in securing the low bid, must submit that piece of equipment for evaluation before the final bid is awarded. A vendor may contact the Survey Scientific Equipment Committee Chairperson prior to the bid letting process to request that Mn/DOT evaluate a new instrument or equipment item for inclusion on the recommended makes and models request. The Survey Scientific Equipment Committee Chairperson will then schedule an evaluation of that equipment item furnished by the vendor.

7-2.0402 Evaluation Report Form

The person evaluating the new equipment is provided with a reporting form "Survey Instrument or Equipment Evaluation" with the equipment for evaluation.

After the equipment has been tested or evaluated, the form is completed and returned to the Survey Scientific Equipment Committee Chairperson. Upon receiving the evaluation report(s), they are reviewed and the vendor is notified of the acceptance or rejection of the equipment to the approved listing.

7-2.0403 Product/Service Problem

If new survey equipment, which is purchased for Mn/DOT, is found to be faulty or unacceptable, a product/service problem form shall be completed and submitted to the Survey Scientific Equipment Committee Chairperson for review and appropriate action.

7-3 EQUIPMENT MANAGEMENT

All surveying equipment purchased for Mn/DOT is assigned and cost accounted to a specific District or Office as per the requisition for purchase. If classed as Fixed Asset equipment by the Mn/DOT Materials Management Unit, it is carried on the District or Office inventory to which it was assigned until it is transferred, retired, or sold. In any event, when a change in status or location of a coded equipment item takes place, there must be a report initiated by the Surveys Section to which it is assigned, on the form designated for that specific action.

7-3.01 DISTRIBUTION AND ASSIGNMENT OF SURVEY EQUIPMENT

All newly purchased surveying equipment, coded or non-coded, is delivered to the Mn/DOT Inventory Center, MS 260, in the Central Office. The non-coded equipment items are marked and sent to the locations specified on the purchase order or requisition. A fixed asset equipment item is assigned a Fixed Asset number with a State Property decal and sent to the assigned District or Office.

The Survey Scientific Equipment Chairperson indicates receipt of equipment and assigned location and sends one copy of the Fixed Assets form with the equipment and one copy to the Mn/DOT Materials Management Unit, MS 215, Central Office.

7-3.02 TRANSFER, TRADE-IN OBSOLETE, JUNKED OR SURPLUS FIXED ASSET EQUIPMENT

When any coded equipment is transferred from one District to another or to the Central Office, a "Fixed Asset Status Change" Std. Form MTL-MGT 132 must be filled out and processed through the Survey Scientific Equipment Committee Chairperson. The Survey Scientific Equipment Committee Chairperson will furnish copies to: District Transportation Materials Supervisor, Central Office Materials Management Unit, MS 215, and if it is a transfer, along with the equipment to its new location.

When a fixed asset (coded) equipment item is no longer serviceable or needed, it should be disposed of and removed from the Fixed Asset Inventory. A "Fixed Asset Status Change" Std. Form MTL-MGT 132 must be completed and processed according to instructions on the form. One copy of Form 132 is to be sent to the Mn/DOT Central Office Materials Management Unit, MS 215.

7-3.03 STOLEN, LOST OR DAMAGED EQUIPMENT

Mn/DOT Personnel Manual establishes individual responsibility for the loss, theft or damage of Mn/DOT property issued or assigned to employees for use in performance of their duties.

When it has been determined that equipment has been stolen, lost or damaged, the supervisor shall be notified immediately. When criminal in nature the proper law enforcement agency will be notified and a complete description of the equipment, dates and all information furnished.

Immediately upon discovery of loss or accident, Admin. Form 782 "Stolen Lost or Damaged Property Report" along with Std. Form MTL-MGT 132 "Fixed Asset Status Change" must be prepared and submitted to the Mn/DOT Central Office Materials Management Unit, MS 215, to retire the asset and its number from the Fixed Assets Inventory.

7-3.04 INVENTORY

An inventory of fixed asset survey equipment is listed for each cost center as a function of Mn/DOT's Materials Management Unit. It is recommended that, in addition to this listing, the Survey Scientific Equipment Committee maintain a database on surveying equipment. Typical information in this database would be: date of purchase; cost; I.D. numbers; transfers; loans; lost or stolen; junked or replaced.

7-4 EQUIPMENT AND MAINTENANCE

Survey instruments such as levels, total stations, GPS equipment and other surveying accessories require constant care and periodic checks to maintain standards of accuracy and error-free operation. Instruments in proper adjustment are more reliable, more accurate, give better service and have a longer life.

7-4.01 FIELD CARE AND ADJUSTMENTS

When survey instruments require adjustments it is most important to refer to the user's manual for procedures to follow. Generally, cleaning, lubrication, and adjustments to internal parts will be made by trained persons through a certified repair service. However, the following list describes equipment and identifies the care to be given and adjustments that can be made in the field.

CARE:

- a. When transporting a total station to or from a survey project or transporting between setups, secure the instrument in its carrying case. Never carry the total station or GPS equipment mounted on the tripod from one setup to another.
- b. Under normal summer conditions, leave the instrument in the carrying case after using if the instrument is dry. Remove the instrument from the case if wet or damp conditions are observed; wipe dry with a soft cloth and leave open in the office to air dry.
- c. When working with the instrument in extremely cold conditions, it should not be taken into a heated room during non-working periods but must be left in the carrying case in the vehicle. If stored in heated area overnight, the instrument must be removed from the carrying case. This procedure avoids steaming up the optics and condensation in the instrument's interior. If the instrument becomes wet or frost covered, bring it into a warm dry room; remove the case and leave it at room temperature to dry out.
- d. Clean lenses and eyepieces with a soft clean cloth, brush, tissue paper, or chamois. Clean the foot screws, tangent screws or other moving parts with a clean cloth or brush. Never use oil or cleaning solvent on the working parts of any surveying instruments. Battery powered equipment should have batteries removed when stored for extended periods of time.

ADJUSTMENTS:

- a. Tripods: Check, clean and adjust all connections on the tripod to be sure they are tight. Adjust the hinged legs located under the head with enough tension so that each leg when raised to a horizontal position and dropped will fall slowly.
- b. Total Stations, Levels, GPS Equipment: Refer to proper manual to make adjustments for specific models.
- c. Tribrach: The tribrach with the built-in optical plummet is used with all the precise surveying instruments. The optical plummet of the tribrach is one of the most vital parts in the measuring sequence since the tribrach is used in both distance and angle measurements, and for precise GPS positioning measurements.

To check the optical plummet for adjustment, use a tribrach adjuster as per the instructions provided with that respective tribrach adjuster.

The tribrach must be checked frequently in the field for proper adjustment of:

1. The footscrews on the tribrach must be smooth operating with a slight drag when alone on the tripod. Adjust these footscrews so the tension on each footscrew is smooth and uniform.
2. The circular bubble on the tribrach is checked for adjustment with the tribrach bubble adjuster. The circular bubble must be adjusted to center inside the circle. This adjustment is made by loosening the screws located on the bottom side of the bubble holder, adjusting the circular bubble and tightening these screws as required. Care should be taken not to over tighten adjustment screws.
3. The optical cross-hair must be checked periodically to see that it is in proper adjustment so that the tribrach is “truly” centered (plumbed), exactly over the point, when the cross-hair is centered on the point.

7-4.02 SERVICING AND REPAIRS

Except for field care and adjustments as stated above in Section 7-4.01, all instrument service and repair will be done through an approved repair service.

Instruments shipped for service must be properly packed according to manufacturer’s instructions. If the instrument is being delivered and picked up at the repair shop, the carrying case is generally all that is needed for transporting.

Tag all instruments with proper addresses when they are being sent out. Cases should have a permanent return address label attached for identification. Also, include its serial number.

Specific instructions will be enclosed along with the instrument stating service required or repairs that may be needed. Be explicit. Request the repair service to provide an estimate for the costs of any repairs not covered under a service agreement.

Budget request for repairs and maintenance of survey and mapping equipment should be made through respective District offices and the C.O. Surveying and Mapping Section.

CHAPTER 8 - SAFETY AND TRAFFIC CONTROL

8-1 INTRODUCTION

8-2 PERSONNEL

8-3 TRANSPORTATION

8-4 EQUIPMENT

8-5 TRAFFIC

8-6 MISCELLANEOUS

CHAPTER 8 - SAFETY AND TRAFFIC CONTROL

“NO JOB IS SO IMPORTANT AND NO SERVICE SO URGENT THAT WE CANNOT TAKE TIME TO PERFORM OUR WORK SAFELY”

8-1 INTRODUCTION

Mn/DOT survey crews may encounter many hazardous situations in a wide variety of hazardous environments.

Survey crews are exposed to potentially hazardous situations which could lead to serious personal injuries or property damage if safety measures are not taken in connection with: personnel, transportation, equipment, and traffic.

It is the policy of Mn/DOT to provide for the safety of its employees. The employees have the responsibility to use all provided safety equipment and follow safety procedures in their daily work, as prescribed in the Mn/DOT Safety and Health Guidelines.

District Survey Supervisors are to maintain a copy of the current Mn/DOT Safety and Health Guidelines for employee reference. Every employee shall have a personal copy of the Mn/DOT Employee Safety Handbook.

Every employee should be familiar with the Article on Job Safety in the Agreement between the employee's union and the State of Minnesota.

Each member of the survey crew is responsible to understand and practice the basic guidelines in Part VII, Field Operations, Section E, Surveying, in the Mn/DOT Safety and Health Guidelines. See Part 1, Section A of the Mn/DOT Safety and health guidelines for responsibilities of the Crew Chief and Supervisor.

8-2 PERSONNEL

It is the survey crew chief's responsibility to ensure that the crew under their supervision performs their work safely. The crew chief should never let any member of the crew start to work without the appropriate personal protective equipment being worn and traffic control in place. No crew should ever try to short cut and do a quick job without first taking the required safety measures to provide for the crew's protection.

Part I, Section A of the Mn/DOT Safety and Health Guidelines spells out the responsibilities of the crew chief as supervisor of the survey crew.

The survey crew chief of a survey crew has the authority to require all members to act and perform their duties in a safe manner.

Each individual on the survey crew has the responsibility and obligation to the other members to work safely. If a crew member sees another member perform an unsafe act, they should call this to the other member's attention regardless whether the unsafe act affects only the individual or the whole crew.

Part I, Section B of the Mn/DOT Safety and Health Guidelines identifies the responsibilities of each employee.

8-3 TRANSPORTATION

The equipment used by a survey crew has the potential to become very hazardous missiles in a survey unit if not properly secured for transport. Before transporting equipment, it should be caged, boxed, properly secured and/or separated from the passenger compartment area. Attentive motor vehicle operation is a very critical element to accident prevention while traveling in a motor vehicle. Even the simple, relaxed fellowship enjoyed by a survey crew driving to and from the worksite can lead to an accident. The motor vehicle operator must remain alert and drive defensively at all times. Crew members must refrain from distracting the driver. Crew members are to assist the driver from outside the vehicle while backing as defined in Part VIII Safety and Health guidelines.

The following publications outline the safety rules that are to be followed by all employees while operating a survey unit.

Part VIII of the Mn/DOT Safety and Health Guidelines, on Mobile Equipment Use, outlines the safety precautions to be followed when operating Department vehicles or equipment.

Mn/DOT Safety Directive on "Seat Belt Usage" requires the operator and all passengers of a motor vehicle to use seat belts.

Mn/DOT Safety Directive on "Motor Vehicle Backing" outlines the safe backing procedures to be followed when operating a motor vehicle.

1998 Minnesota Rules - Vehicles 5205.0750 outlines the requirements for motorized self-propelled vehicles.

Minnesota Department of Natural Resources Recreational Motor Vehicles Regulations - 1999 outlines the laws, rules and regulations for recreational motor vehicles which include All-Terrain Vehicles (ATVs) which are used by many survey crews.

The survey crew chief is responsible for the safe operation of survey units by employees under their supervision.

8-4 EQUIPMENT

Part X of the Mn/DOT Safety and Health Guidelines contains the basic safety rules to follow in the use of tools, machines and portable equipment.

Survey crews use portable power tools on a regular basis. Examples include:

- a. Portable drills and air hammers - used to cut pavements, drive alignment pins in bituminous and base, drill holes in concrete and rock for monuments, drive plat monuments, drive coupled rod for bench marks, etc.
- b. Chain and brush saws - used to clear survey lines.
- c. J-Tampers - used in compacting the backfill in our roadway corner excavations.
- d. Portable generators - used for warning light systems.

The following is a list of the safety equipment that is carried in a fully equipped survey truck:

- a. 2 - 48 in Survey Crew Ahead signs.
- b. 8 - 28 in Reflectorized Traffic Cones (minimum number that must be carried by each vehicle).
- c. 1 - Flagger Paddle (Sign W21-X7) in Standard Signs Manual
- d. Personal Protective Equipment for each employee which includes:
 1. High visibility safety vests/clothing.
 2. High visibility head gear (high visibility soft cap and hard hat).
 3. Safety protective eyewear.
 4. Personal hearing protection.
 5. Field Manual on Traffic Control.

Each employee is responsible to wear personal protective equipment when required: i.e. high visibility garments and head gear is required when working along the road or highway right of way.

Additional safety and traffic control equipment is available to the survey crews within each district when needed.

All survey equipment is to be removed from the roadway as soon as it has served its purpose. No lath, pickets, cones, tripods or any other equipment is to be left in a traffic lane when it is no longer needed.

When parking the survey unit, position the unit in a safe location and activate the advance warning lighting to warn motorists. Whenever possible, work should be performed on the same side of the road that the survey unit is parked. If the work is being performed on the opposite side of the road from where the survey unit is parked, additional traffic warning devices (cones, signs, barricades etc.) may be necessary.

Survey crew members must be alert and cognizant of traffic conditions at all times. Avoid complacency and be alert to oncoming traffic. Survey operations should be set up off the roadway whenever possible. Before beginning survey operations on a roadway, this should be discussed with the Survey Crew Chief.

8-5 TRAFFIC

All traffic control shall conform to the latest edition of Mn/DOT's Temporary Traffic Control Zone Layouts Field Manual, hereafter referred to as the Field Manual. This Field Manual is a section of Part VI of the Minnesota Manual on Uniform Traffic Control Devices (MN MUTCD).

Within each district advance warning signs and other traffic control equipment required for temporary lane closures is available. The survey crew chief should never hesitate in requesting temporary traffic control equipment. Contact the District Traffic Engineer/Maintenance Supervisor for help and advice in setting up temporary traffic control lane closures.

The Field Manual ("Miscellaneous" section) includes signing layouts designed for short duration (1 hour or less) survey situations during the off-peak hours in good visibility, low volume (1500 ADT or less) locations. These signing situations utilize safety equipment readily available to the crew and in most cases at hand in their fully equipped survey truck (see minimum requirements in Section 8-4). With normal caution, an alert 2 to 4 person survey crew can work safely in these situations without additional units to carry equipment.

For situations longer than one hour, where visibility is questionable, or where the ADT is more than 1500, use the appropriate traffic control layout in the Field Manual.

Proper cone placement is extremely important, particularly on tapers. Two-way traffic tapers are kept relatively short. In this situation, the function of the taper is not to cause traffic to merge, but rather to resolve the potential head-on conflict. A short taper is used to slow down traffic by giving the appearance of restricted alignment. A flagger is usually employed to assign the right of way in such situations.

On four-lane divided highways, tapers are kept long to effectively channel and move traffic around the work area. Long tapers give the driver ample time to gradually merge into the adjoining traffic lane with a minimum of disruption to traffic flow.

For any nighttime operation or any survey operation not covered in the Field Manual, the signing should be discussed and reviewed with the District Traffic Engineer/Maintenance Supervisor and/or District Safety Administrator.

The use of buffer zones in traffic control setups is an effective means of separating workers from oncoming traffic. It is recommended that buffer zones be used whenever the crew is working on the shoulder or within a lane closure. Minimum lengths of buffer zones are shown in the Field Manual traffic control layouts.

8-6 MISCELLANEOUS**CONFINED SPACE ENTRY**

Be aware of the hazards associated with entry into confined spaces such as manholes, culverts, storm sewers, etc. Specific confined space training before entry and on an annual basis along with specialized equipment is required to recognize and assess confined space hazards which include atmospheric testing, ventilation and written permit requirements, fall protection, communication measures and rescue procedures.

ALL TERRIAN VEHICLE (ATV)

Only employees that have been instructed in the safe operation of ATVs are permitted to operate an all-terrian vehicle. While operating an ATV within a road right of way, the following is required: operational 360 degree warning beacon, slow moving vehicle sign mounted to the rear, and traffic control in accordance with the Field Manual (Part VI of the MN MUTCD). Operators and all passengers of ATVs are required to wear a DOT/SNELL approved helmet unless, the ATV has a roll over protective device or substantial cab and the operator and all passengers have a seat belt employed.

APPENDIX A - CONTRACTOR STAKING

A - 1	INTRODUCTION
A - 2	MINIMUM REQUIREMENTS
A - 3	WORKING RELATIONSHIPS
A - 4	MN/DOT SURVEY SUPPORT
A - 5	SCOPE OF WORK
A - 6	END OF PROJECT SUBMITTALS
TAB - 1	PROPOSED SPECIAL PROVISION FOR CONTRACTOR STAKING
TAB - 2	STAKING GUIDELINES (STANDARD PLAN SHEET NO. 5-297.115 (2 SHEETS))

A – 1 INTRODUCTION

Construction staking is addressed in other Mn/DOT publications, such as Chapter Six of the *Mn/DOT Surveying & Mapping Manual*, or the *Mn/DOT Technical Manual*. However, such publications are written from the assumption that the personnel doing the construction staking are either Mn/DOT employees or employees of a consultant under direct contract to, and under the direct supervision of, Mn/DOT construction and survey personnel.

While the publication of *Appendix A* to the *Surveying and Mapping Manual* (hereinafter referred to as *Appendix A*) in no way negates the information provided elsewhere, it does recognize that a different dynamic is in play when the personnel doing the construction staking are employees of the prime contractor or of a subcontractor under contract to the prime contractor. The intent of *Appendix A* is to supplement and clarify the construction staking information provided elsewhere and such information is expressly made a part of *Appendix A*.

Additionally, *Appendix A* will provide the prospective surveyor with a clearer picture of what is expected. This will benefit the surveyor in three ways. First, it will provide a firm basis from which to develop an estimate for bidding. Second, it will promote uniformity within Mn/DOT, reducing the uncertainty of what is required when moving from one District to another. Third, by providing everyone with the same understanding, it will promote a uniform playing field for developing bids, thereby eliminating loss of work to competition that underbids a project due to not understanding all that is involved in the project.

Furthermore, by assuring that the surveyor is qualified and fully informed of what is required of them, it will provide Mn/DOT and, through the Department, the people of Minnesota the greatest value for their transportation construction dollar.

Appendix A is the synthesis of work done by several committees formed to address the issues surrounding contractor staking. These committees were comprised of Mn/DOT construction and survey personnel as well as members of the private sector surveying community. *Appendix A* is meant to be read not only by the surveyor, but also by the prime contractor intending to use contractor staking and those Mn/DOT construction and survey personnel that will be interacting with contractor staking personnel.

Appendix A supplements *Mn/DOT Technical Memorandum TM-05-08-RWS-01 Contractor Construction Surveying Specifications*. Any questions or comments on *Appendix A* should be directed to the Assistant Director, Surveying and Mapping Section of Mn/DOT's Office of Land Management.

A – 2 MINIMUM REQUIREMENTS

A – 2.01 INTRODUCTION

While criteria exist under Mn/DOT's Consultant Pre-qualification Program for consultant construction staking, the nature of the relationships and working environment differ between consultant staking and contractor staking. Because of these differences, contractor staking requires a different set of qualification criteria from those applied when the construction staking is under direct Mn/DOT control. This section identifies the minimum criteria that must be met in order to assure a successful contractor staking experience.

In order to be eligible to perform contractor staking on a Mn/DOT project, the Department, the prime contractor, and the surveyor (who may be the same entity as the prime contractor) must meet certain minimum requirements.

A – 2.02 MN/DOT REQUIREMENTS

Mn/DOT must identify the project as being eligible for contractor staking when the project is let for bidding. The RFP will include a line item *2011.601 Construction Surveying, Lump Sum*.

Additionally, to assure that the Mn/DOT inspector/engineer understand the different nature of the working relationships and expectations involved in a contractor staking environment, the Mn/DOT inspector/engineer who will be assigned to the project must have read and understand the contents of *Appendix A*.

A – 2.0201 Prime Contractor Requirements

The prime contractor, in order to assure that he/she understands the different and unique working relationships and expectations involved in the contractor staking environment, will submit a signed statement to the effect that they have read and understand *Appendix A*.

A – 2.0202 Surveyor Requirements

The surveyor, in order to assure that he/she understands the different and unique working relationships and expectations involved in the contractor staking environment, will submit a signed statement that they have read and understand *Appendix A*.

The reason contractor staking is being employed is the fact that Mn/DOT does not possess the resources to staff the particular construction project in question. Nor, does Mn/DOT possess the resources to provide training and supervision of the surveyor's personnel. Given these facts, and the critical impact that staking can have on the progress, cost, and outcome of the construction project, it is necessary for Mn/DOT to have some assurance that the personnel performing the construction staking are qualified in this area. Therefore, the survey party chief on all construction projects let after 31 August 2007 will be required to hold NSPS - ACSM certification at Level III, Construction Survey Party Chief.

The surveyor will provide proof of this certification. Alternatively, the on site party chief may be an LSIT, or a licensed Surveyor/Engineer.

Furthermore, the contract-staking program must be under the supervision of a land surveyor licensed by the Minnesota Board of Architecture, Engineering, Land Surveying, Landscape Architecture, Geoscience, and Interior Design (AELSLAGID). If the surveyor will not be delineating right-of-way or easement at any time during the project, an engineer registered with AELSLAGID, rather than a land surveyor, may supervise the work.

A – 3 WORKING RELATIONSHIPS

A – 3.01 INTRODUCTION

Chapter 6 of the *Mn/DOT Surveying and Mapping Manual* deals with construction staking. In *Section 6 – 3.01 Communications*, it states, “...a smoothly operating project [requires]...good communications between the contractor, the engineer, the surveyor, and inspectors.” Part of the basis of this good communications is a clear understanding of the roles and interrelationships among the parties involved. This section seeks to identify these different roles and relationships.

This section will begin by defining issues common to all parties. It will then look at those issues of unique concern between A) the prime contractor and the surveyor, B) the prime contractor and the Mn/DOT inspector/engineer, and C) the surveyor and the Mn/DOT inspector/engineer.

Some of these issues will be formalized (see *TAB- 1 to Appendix A*) while others will remain informal. In either case, it is best to remember the recommendations of the Working Relationships Subcommittee, “Communication and expectations are significant aspects of good working relationships. These are built on a project-by-project basis. We want to stress developing and maintaining these *before, during, and at the end* of a construction project.”

As many facets of the relationships between the parties involved in construction staking are affected by the scope and nature of the work to be performed, there is some overlap between the material presented in this section and that presented in *Section A – 5 Scope-of-Work*.

A – 3.02 BETWEEN THE PRIME CONTRACTOR – SURVEYOR – INSPECTOR/ENGINEER

Certain issues or aspects of the working relationships involved in construction staking are common to all of the parties involved.

A – 3.0201 Keeping the Relationship Professional

That each of the parties must be technically competent to perform their designated functions goes without saying. However, being competent is not enough. It is also necessary to recognize that the other participants in the project bring their own competence and unique perspectives to the project. An acceptance of this fact will facilitate professional working relationships and smooth project flow.

Maintaining professional working relationships, allows problems to be resolved based upon their technical considerations and impact on the project rather than based upon personalities and force of will. This produces the best overall result for the citizens of Minnesota.

A – 3.0202 Communications

As stated in the introduction to this section, as well as in other Mn/DOT publications, communications is an essential component of a smooth running

project. Therefore, while the prime contractor is responsible for developing a construction staking communications plan, the surveyor and the Mn/DOT inspector/engineer, must have input to it.

The construction staking communications plan should address the following:

- Who will assign staking work to the surveyor
- Who will prioritize the staking
- How do Mn/DOT personnel request staking support
- How will assignment and prioritization be communicated
- How will problems and changes be communicated
- How will the completion of staking assignments be communicated
- How much advance notice is required for each of the above

Additionally, there needs to be a mechanism, whether identified in the special provisions, the applicable *Standard Specifications for Highway Construction*, or elsewhere, for resolving conflicts that may arise during the course of the project so that costly delays do not occur. Some of these problems may include:

- Ambiguities within the plan
- Plan errors
- Staking errors
- Design changes

It is also important that the prime contractor, surveyor, and Mn/DOT inspector/engineer attend all project meetings (pre-construction, project progress/update, and end-of-project). This will facilitate the clarification of roles and the resolution of problems on the project and provide input for improvement of the contractor staking process.

A – 3.0203 Staking Requirements

While the surveyor is providing stakes to guide the prime contractor's efforts, it needs to be understood by all parties that the Mn/DOT inspector/engineer also relies upon the construction staking for quality control and determining pay quantities. The *staking guidelines* plan sheets (an example is included as *TAB - 2*) identify the minimum staking requirements to meet these quality control and pay quantity needs.

Similarly, it needs to be recognized that if additional staking beyond that identified at the project's outset is requested, it will be the obligation of the requestor to pay for that additional staking.

Lastly, and this is a point that will be covered in *Section A - 5*, the surveyor needs to understand that they are responsible for any staking/surveying that may be required under the project documents. This includes staking/surveying that is incidental to other work, such as verifying the clearance of drainage crossings of utilities or verifying elevations and locations where planned construction ties to the existing topography.

A – 3.03 RELATIONS BETWEEN THE PRIME CONTRACTOR AND SURVEYOR

As stated earlier, the surveyor is either an employee of the prime contractor, or a subcontractor to the prime contractor. Because of this relationship, there are certain issues and obligations that exist between the two parties.

A – 3.0301 Issues in Common

Before construction, secure a complete copy of the construction plan, proposal, and special provisions. The prime contractor and surveyor should go over these documents to assure that they both have the same understanding of the project's staking and survey needs. (Don't forget to consider the needs of the Mn/DOT inspector/engineer as reflected by the *staking guidelines*.)

Once the staking/survey needs have been identified, a staking schedule should be agreed upon. This schedule will take into consideration such factors as production rates, the number of personnel to be assigned to staking and how often they will be on the project site, and how re-staking will be dealt with.

A – 3.0302 Prime Contractor

The prime contractor is responsible for developing the construction staking communications plan. The prime contractor needs to prioritize the requested staking. An individual identified by the prime contractor will be the source of staking requests for the surveyor. All staking requests must go through this individual. There are several reasons for this. Since the prime contractor pays the surveyor, they are more likely to get a prompt response to the requests. Also, since the prime contractor pays the surveyor, they should be the ones to initiate work that may generate additional billing by the surveyor.

The prime contractor needs to document any additional staking requested by Mn/DOT (beyond what would be in compliance with the *staking guideline* sheets) for submission to Mn/DOT for payment.

The prime contractor needs to document the reasons and costs for any additional staking required due to factors beyond their control. Examples would include plan errors or Mn/DOT initiated plan changes. Not considered justification for additional charges to Mn/DOT are: re-staking caused by a change in the prime contractor's work schedule, contractor initiated plan changes, carelessness by the prime contractor's personnel, staking or re-staking that is necessary for the contractor to complete some other aspect of the project, re-staking caused by originally staking an obvious design error, or poor utilization of the surveyor.

A – 3.0303 Surveyor

The surveyor receives their instructions from the prime contractor and is answerable to the prime contractor. Survey requests from any other source should be directed to the prime contractor for approval prior to commencing work. Should additional work become necessary, the surveyor must notify the prime contractor and receive approval before proceeding with such work.

The surveyor needs to keep the prime contractor informed of how the requested staking is progressing. If problems arise, the surveyor must notify the prime contractor immediately, before engaging in any activities that will incur additional expense. The surveyor should inform the prime contractor, and the Mn/DOT inspector/engineer, of any errors, design or staking, as soon as they are discovered.

The surveyor must document the work performed as well as any problems encountered. The surveyor should be prepared to provide the prime contractor with any notes, computations, maps, or files produced as a part of the project staking.

A – 3.04 RELATIONS BETWEEN PRIME CONTRACTOR AND INSPECTOR/ENGINEER

In addition to those items identified in A – 3.02, there are specific issues that arise out of the relationship between the prime contractor and the Mn/DOT inspector/engineer.

A – 3.0401 Prime Contractor

The prime contractor must obtain permission from the Mn/DOT inspector/engineer before proceeding with work. This includes surveying and changes to the plan. The prime contractor must notify the Mn/DOT inspector/engineer of design or staking errors as soon as they are discovered.

If the prime contractor will incur additional staking costs due to circumstances beyond their control, they must notify the Mn/DOT inspector/engineer of the nature of the additional work, why it is required, and the estimated cost of such work before proceeding.

The prime contractor shall keep the Mn/DOT inspector/engineer informed of the staking schedule and progress. They will also convey Mn/DOT staking requests to the surveyor, informing the Mn/DOT inspector/engineer if additional costs are involved for such staking.

The prime contractor will handle requests from the Mn/DOT inspector/engineer for survey data, notes, or information.

A – 3.0402 Inspector/Engineer

Recognizing that the surveyor is an employee or subcontractor of the prime contractor, rather than of Mn/DOT, the Mn/DOT inspector/engineer will work through the prime contractor on all surveying issues. This will avoid the problem of the contractor incurring unnecessary, or unknown, staking expenses. (As previously stated, the Mn/DOT inspector/engineer relies upon the construction stakes for various purposes. The *staking guidelines* sheets in the plan represent the staking required for the Mn/DOT inspector/engineer to perform their work. Should the prime contractor not require the indicated stakes

in order to construct the project, they are still considered a part of the project and will not incur additional costs for their initial placement at the request of the Mn/DOT inspector/engineer.)

The Mn/DOT inspector/engineer will define the process for authorizing changes proposed by the prime contractor. No work may be performed until authorized by the Mn/DOT inspector/engineer. The Mn/DOT inspector/engineer will document the acceptable work performed by the contractor and authorize payment. The Mn/DOT inspector/engineer will be involved in all meetings regarding: plan changes, removals, determination of quantities, project documentation, and changes in the project schedule.

As well as approving contractor-initiated changes, the Mn/DOT inspector/engineer will respond to any plan errors discovered by the prime contractor. The Mn/DOT inspector/engineer will provide the prime contractor with any Mn/DOT corrections or changes to the plan. At such time, the prime contractor will be asked to submit an estimate of the associated costs if re-staking is required.

A – 3.05 RELATIONS BETWEEN INSPECTOR/ENGINEER AND SURVEYOR

Generally speaking, direct interaction between the surveyor and the Mn/DOT inspector/engineer will be minimal. Requests of the surveyor should go through the prime contractor, as should issues of concern to the surveyor.

A – 3.0501 Inspector/Engineer

The prime contractor, not the Mn/DOT inspector/engineer, directs the work of the surveyor. None-the-less, the Mn/DOT inspector/engineer documents the surveyor's work for purposes of payment to the prime contractor.

The Mn/DOT inspector/engineer may request staking to assist in their work (within the limitations of the *staking guidelines*) through the prime contractor. The timing of such requests is critical, as re-stakes will most likely incur additional costs to Mn/DOT.

The Mn/DOT inspector/engineer may request that Mn/DOT survey personnel check on work performed by the surveyor. If such checks reveal errors in the survey work, the surveyor will be required to correct them at no additional cost.

A – 3.0502 Surveyor

The surveyor should produce all the necessary supporting documentation (i.e. field notes, computations) for work performed. Such documentation must be made available (through the prime contractor) to the Mn/DOT inspector/engineer.

The surveyor must inform the Mn/DOT inspector/engineer of any problems, staking or plan errors, or additional staking that will result in additional costs to Mn/DOT.

The surveyor must attend project meetings and be available to discuss project related problems.

The surveyor may request that Mn/DOT survey personnel check on work performed or provide additional assistance. Such work performed by Mn/DOT survey personnel shall be charged to the prime contractor at the rates set forth elsewhere in *Appendix A* or in the applicable *Special Provisions*. The scheduling of such checks or assistance will be determined by the availability of Mn/DOT resources.

A – 4 MN/DOT SURVEY SUPPORT

A – 4.01 INTRODUCTION

This section identifies the information and support that may be available to the surveyor from Mn/DOT. This may come in the form of publications such as manuals, specifications, plans, material such as control monuments already in place, or consultation with Mn/DOT personnel.

A – 4.02 MANUALS

Mn/DOT publishes numerous manuals to provide information and guidance to personnel performing work for the Department. Of particular interest to the surveyor who will be performing contractor staking are the following:

- *Appendix A*
- *Surveying and Mapping*
- *Construction*
- *Technical*
- *Standard Plates*
- *Standard Plans*
- *Road Design*
- *Bridge Design*
- *Right of Way*

Some of these manuals contain procedures and standards that must be adhered to by the surveyor. Others provide information that will assist in the interpretation of the construction plan.

A – 4.03 SPECIFICATIONS

The appropriate edition (the one identified in the construction plan) of the Mn/DOT *Standard Specifications for Construction* as well as any supplements or *Special Provisions* provide additional information on required standards and procedures to be followed.

A – 4.04 CONSTRUCTION PLAN

The surveyor will be provided a copy of the construction plan. The plan may exist in either hardcopy format, electronic format, or both. In hardcopy format, the plan will consist of the printed versions of the CAD files. In electronic version, the plan will consist of the Microstation® CAD files and associated GeoPak® files.

In either format, the plan contains a wealth of information to guide the surveyor in staking the project. Often, information relevant to a particular task may be dispersed over several different sheets/sections of the plan. It is the surveyor's responsibility to perform the necessary crosschecks within the construction plan before staking. Any errors or discrepancies should immediately be brought to the attention of the Mn/DOT inspector/engineer.

The surveyor should be sure to use the advertised plan. Copies other than the advertised plan may not be exactly the same as the advertised plan. Changes could possibly have been made to the plan, unbeknownst to the designer, after it was sent to the Central Office. It is the responsibility of the surveyor to check this out and discuss the changes with Mn/DOT personnel.

Following is a brief listing of the key components of the plan and the information that each provides to the surveyor.

A – 4.0401 Title Sheet

The *title sheet* is the first page of the plan. Information of value to the surveyor staking the project includes the following:

The limits of the project

- A vicinity map showing the approximate location of the project
- A heading describing the primary project focus (i.e. grading, signals)
- The edition of the *Standard Specifications for Construction* that applies to the project
- An index of all of the sheets in the plan with the sheet numbers
- There will be a design designation that will show the design speed and the average daily traffic (useful if the *Road Design* manual needs to be checked)
- There will be the engineers' signatures block (providing contact information for obtaining answers to questions about the plan)
- The State Project number will be listed.

A – 4.0402 Estimated Quantities

The *estimated quantities sheets* lists the following information of value to the Surveyor:

- Item number (this corresponds to the governing specification in the *standard specifications for construction*)
- Item description
- Tabulation sheet and table (location in the plan where more detailed information on the amount and location of this item is listed)
- The unit the item is measured in (i. e. lineal foot, square yard)
- Total quantity (how much of that particular item (type of work) is included in the project (this can serve as a guide in determining estimated costs to survey the project)
- Notes to explain some of the quantities

A – 4.0403 Standard Plates

The plan includes a table listing the *standard plates* that apply to this project. The Surveyor should pay close attention here, as the most recent version (the one found in the *Standard Plates* manual) is not necessarily the one that applies to this project. Standard plate *4160D Curb Box Casting for Catch Basin* is different from standard plate *4160C Curb Box Casting for Catch Basin*. Standard plates can be viewed at <http://www.dot.state.mn.us/tecsup/splate/>

A – 4.0404 Earthwork Tabulations

Earthwork Tabulations show the type and quantity of material that is being moved. The *earthwork tabulations* show the volumes of each material by stationing. In addition, there will be an earthwork summary showing the total amount of each item to be used on the project.

A – 4.0405 Pay Item Tabulations

The *pay items tabulations* provide more detailed information than the *estimated quantities sheets*. In addition to the information found on the *estimated quantities sheets*, the *pay item tabulations* identify specific locations on the project where the work involving the listed quantities occurs. These should always be crosschecked against the respective *inplace topography*, *typical section*, and *construction plan sheets*. As in the case of the *estimated quantities sheets*, the *pay item tabulations* may contain notes providing additional information.

The *pay item tabulations* include such things as:

- Clear and grub quantities
- Retaining wall information
- Guardrail information on the type and quantity
- Subsurface drainage, commonly known as perforated pipe quantities
- The summary of the pavement types (concrete, bituminous, and aggregate information)
- Curb and gutter, including the type
- Any new culverts will be tabulated.
- Erosion control items and any turf establishment areas
- Fencing
- Removals of any existing items of the types listed above

These can be used not only to guide in staking the project, but also as an aid in preparing a bid for the project survey work.

A – 4.0406 Inplace Utility Plan and Tabulations

The *inplace utility plan sheets* and *inplace utility tabulation sheets* provide information on the known utility locations at the start of a project. They identify the locations of existing utilities in relation to the existing topography and the proposed construction, providing a visual clue as to which utilities will be in the way and need to be moved. (It is the construction surveyor's responsibility to stake the necessary utility relocations.)

The *inplace utility tabulation sheets* contain a tabular listing of the information shown on the *inplace utility plan sheets*. They supplement this information with the following:

- Point numbers for all of the jogs in the in-place utilities
- The utility runs showing from what point number to another that a utility travels
- The names of the referenced alignments
- Station and offset to all of the points that were located on the utilities
- What is in-place (pole, conduit, type and size of pipe)
- The names of the owners of the utility
- Whether a structure is to be adjusted or reconstructed
- Additional notes concerning the utilities listed

A – 4.0407 Typical Sections

The *typical sections sheets* contain representative diagrams of each of the roadways to be built on the project. The following information, of interest to the surveyor staking the project, can be found on these sheets:

- The percent of grade for each lane is shown
- The percent of grade for the inslope to the highway is shown
- The percent of grade for the backslope going up from the ditch is shown
- The standard ditch width is shown
- The type of curb and gutter and where it is located
- The type of median barrier and where it is located
- The depth of each material is shown for each section in a small detail
- Alignment identifiers are listed
- Stationing showing where the typical is to be used
- Any area that has a variable slope is shown
- The location of the profile grade as it relates to the typical is shown
- The sub grade treatment is shown for each section
- There are notes listed to clarify difficult areas

As the name implies, these diagrams are typical and do not represent every situation. The *typical sections sheets* must be used in conjunction with, and crosschecked against, the *pay item tabulations, construction plan, superelevation, profile, and cross-section sheets*. It will be the responsibility of the surveyor to determine how the typical sections apply to any unique (non-typical) portions of the project.

A – 4.0408 Standard Plans

The *standard plan sheets* cover items that are uniform from one plan to the next. A few examples are *Standard Acceleration and Deceleration Lanes* and *Bridge Approach Panel Conc. Mainline Joint at Abutment (Square to 10 Degree Skew)*. They also include the *Staking Guidelines*. In addition to the plan, *standard plans* can be found in the *Standard Plans* manual or online at <http://www.dot.state.mn.us/tecsup/splan/>. The *standard plan sheets* often contain details of importance to the surveyor staking a project.

A – 4.0409 Staging Plan

The *staging plan sheets* depict the configuration of the different stages of construction that are planned. For each stage of construction these sheets show:

- A plan view of proposed construction, to include any bypasses or temporary drainage required
- The area of construction for that stage is shown in cross-hatching
- There are notes relating to the stage
- The alignments that are being used on that particular stage

In addition, the right of way and temporary easements are shown for reference.

It should be noted that the staging for the project is usually worked out in detail by the designer. If the staging is altered, this may result in the need to extensively re-engineer other aspects of the plan. When the contractor changes the staging for their own convenience, it will be the contractor or contract staking surveyor's responsibility to make the necessary changes throughout the plan.

A – 4.0410 Horizontal Alignment

The *horizontal alignment sheets* provide information about the existing and proposed alignments for the project. They are necessary whenever trying to locate something that is referenced to an alignment (i.e. a grading stake, an area trees to clear and grub.) The *alignment tabs* include the following:

- PC (the point of curvature of a curve)
- PT (the point of tangency of a curve)
- PI (the point of intersection of the long tangents)
- The radius point of the curve
- Coordinate values for all of the curve points
- A datum statement for the coordinates (be sure to check this against the control datum)
- The curve elements (delta, degree of curve, radius, tangent length, length of curve, and the front and back azimuth)
- Stationing for all of the curve points
- Any equations that occur in the alignment are shown with coordinates for the point

An electronic file, in GeoPak® format, of the alignments will be available.

A – 4.0411 Inplace Topography

The *inplace topography sheets* depict the existing and proposed alignments in relation to the topography that is in place when the project began. In addition, the construction limits, right-of-way, and temporary easements are shown. It should be noted that the R/W and easements shown are graphical in nature; any determination/staking of the R/W should not be based on these lines. Rather, R/W information should be obtained from the District Surveys Office. As a

reminder, if the contract surveyor will be staking/marketing any R/W or easement locations, this must be done under the supervision of a land surveyor licensed to practice in Minnesota.

A – 4.0412 Construction Plan

The *construction plan sheets* provide a planimetric view of the proposed construction. They should be crosschecked against the *alignment sheets, superelevation sheets, typical section sheets, cross section sheets, pay item tabulation sheets, standard plan sheets, detail sheets, drainage sheets, and standard plates.*

The *construction plan sheets* contain the following items of interest to the surveyor staking the project:

- Proposed alignments
- Right-of-Way and temporary easements (see the comments under *inplace topography*)
- The location and type of curb and
- Lane widths and shoulder widths
- The radius points for all the curved sections
- The location and ratios of lane tapers
- Fencing locations
- Trails and walks with their type and width
- Any detail areas that need to be expanded for clarity are shown

A – 4.0413 Roadway Profiles (Vertical Alignment)

The *profile sheets* show the proposed roadway grades. Information included as part of the grade consists of:

- The VPI, which is the vertical point of intersection of the curve
- The VPC, which is the vertical point of curvature
- The VPT, which is the vertical point of tangency
- Elevations for all of the above points
- The input grade which is the grade coming into the vertical curve
- The output grade which is the grade going out of the vertical curve
- The length of the vertical curve
- Stationing is shown which relates to the horizontal alignments

In addition, the *profile sheets* show the difference between the finished grade and grading grade, as well as the depth of any subgrade excavation, and whether the profile grade runs down the roadway centerline or is offset. These should be checked against the *typical sections* and *cross sections*. Lastly, if there are special ditch grades, they can be found here.

A – 4.0414 Superelevation

The *superelevation sheets* show a plan view of the areas that are in transition from a normal typical section to a superelevated section. The *superelevation sheets* show the maximum percent of superelevation for an area, as well as the beginning and ending stations of the superelevation transition. The cross slope

percent of grade at different transition points is shown. Wherever there is a zero percent cross slope, it is shown. The information on the *superelevation sheets* should be checked against the *typical section* and *cross section sheets*.

A – 4.0415 Structures and Walls

These sheets show the plan and profile views of the walls to be constructed. The footing layout for each wall is shown, along with the alignment stationing for key points along the wall and footing. Any details to clarify the building of the wall are also shown. The *structure and wall sheets* should be checked against the *alignment, construction, typical section, and cross section sheets*, as well as the pertinent *standard plan sheets* and *standard plates*.

A – 4.0416 Drainage Plan

The *drainage plan sheets* show the location of all the drainage structures, such as manholes, catch basins, culverts, and pipe. The number of each drainage structure is shown as well as the direction of flow from one structure to another. Pond locations may be shown on the *drainage plan sheets*.

Road alignments are shown for referencing the structures to stationing. Right-of-way and temporary easements are shown. (The earlier comments regarding R/W depicted on the plan apply.)

Information from the *drainage plan sheets* should be checked against the *drainage tabulation, drainage profile, superelevation, profile, typical section, and construction plan sheets* as well as the appropriate *standard plates*.

A – 4.0417 Drainage Profile

The *drainage profile sheets* show all the drainage structures, such as manholes, catch basins, culverts, and pipe. Each structure and pipe end/apron has an associated point number. This is the same point number shown on the *drainage plan* and *drainage tabulation sheets*.

Each structure or apron is referenced to a plan alignment, showing the stationing and offset to the structure from the referenced alignment. The top of casting elevation, as well as the invert elevations of all pipes flowing into or out of the structure, are shown. The type of pipe, such as corrugated metal or reinforced concrete, is identified. For each pipe run, the size, length, percent of grade, and structures located along the pipe are shown.

Information from the *drainage profile sheets* should be checked against the *drainage tabulation, drainage plan, superelevation, profile, typical section, and construction plan sheets* as well as the appropriate *standard plates*.

A – 4.0418 Drainage Tabulations

The *drainage tabulations* provide a tabular listing of the information shown on the *drainage plan* and *drainage profile sheets*. This is supplemented with the following additional information:

- Notes to clarify different items about the drainage system
- Coordinate values are shown for each structure
- The structure design is shown for each one
- Pipe heights for the structures are listed
- Casting assemblies for each structure are shown
- What structure a pipe drains to
- Guideposts for the outlets are listed
- If there is riprap at the outlets of the pipe runs, the quantity is listed

Information from the *drainage tabulations* should be checked against the *drainage plan, drainage profile, superelevation, profile, typical section, pipe item tabulations, and construction plan sheets* as well as the appropriate *standard plates*.

A – 4.0419 *Special Ditches*

This is a sheet showing a special ditch. Special ditches are ditches that do not follow a typical section design. These are sometimes shown on the *drainage plan sheet* but not always. They are always included on the *cross section sheets*. The elevations of the ditch at each section are shown with the designation of SDG near the elevation.

A – 4.0420 *Traffic Control*

The *traffic control sheets* provide a layout of the proposed detours for the project. They also include a signing layout showing what signs are to be used, when and where, to indicate the detours. There is a tabulation listing the traffic control signs, with details about the signs as necessary. The *traffic control sheets* should be checked against the *staging plan*.

A – 4.0421 *Lighting Plan*

The *lighting plan* shows:

- The locations for the lighting structures that are to be installed
- Structure types
- Any details for the plan or structures
- Salvage and removal information
- A legend explaining the symbols and such that are shown
- A tabulation showing the number, stationing, location, and the type of each lighting structure
- Electrical service information needed for the lighting system

Lighting plans are sometimes let for construction as separate plans. In such a case, they may include some of the other plan components described in *Section A– 4.04*.

A – 4.0422 *Traffic Signal and Sign Plans*

The *traffic signal and sign plans* provide information on the location of traffic signals and signs. Traffic signals include not only the actual semaphore lights,

but also the loop detectors, hand holes, control cabinets, and interconnects that make up the traffic signal system. In addition to standard roadside signs, the *sign plan* includes overhead, cantilever and bridge, signs.

Information of interest to the surveyor staking the project includes:

- A legend showing different symbols and notations
- Abbreviations for the different parts of the signals and signs
- Standard plates reference
- Loop detector, hand hole, signal, and sign locations
- The intersection layout for the entire system is shown
- Any pole details for the signal poles being installed are listed
- Details and tabulated information for signs

It should be noted that in some cases, Mn/DOT's Traffic Engineering personnel may prefer to mark the signal locations in the field. The surveyor should coordinate this through the prime contractor.

Information on the *traffic signal* and *sign plans* should be checked against the, *superelevation, profile, typical section, pay item tabulations, grading plan, and construction plan sheets* as well as the appropriate *standard plates*.

Traffic control and sign plans are sometimes let for construction as separate plans. In such a case, they may include some of the other plan components described in *Section A – 4.04*.

A – 4.0423 Grading Plan

The *grading plan*, sometimes referred to as the *contour sheets*, depicts the proposed final contours for the project. Information of use to the surveyor staking the project includes:

- The final contours for the areas to be graded
- Spot elevations that are needed to delineate certain desired elevation points
- Slopes in different areas
- Ponding areas that will be needed
- Proposed roadway alignments, R/W, easement, and construction limits
- Some of the in place topography is shown
- Notes needed to clarify an area of grading
- Drainage structures and pipes

The earlier comments regarding R/W depicted on the plan apply here. The *grading plan* should be checked against the *profile, cross section, and typical section sheets*.

A – 4.0424 Cross Sections

The first sheet(s) of the *cross section sheets* consists of a plan view showing where all of the cross section were cut in the plan. The next sheets will show the actual cross sections. The cross sections will show:

- Touch down points where the cross sections match the in place ground
- Areas of cut and fill
- The centerline alignment and for the alignment that they are referenced to and also any alignment centerlines that the section cuts across
- The station at which the cross section is cut
- Centerline elevations of the finished top of pavement each section
- The in place ground line
- The typical section for that section is drawn in
- The slopes of the inslope and backslope
- Ditches, along with any special ditch grades
- Buried utilities are shown in the section
- Right-of-way and temporary easement lines are shown at each section
- Match lines for large sections are shown

There are several considerations to bear in mind when using the *cross section sheets*. Firstly, the already mentioned caution regarding R/W lines shown on the plan. Secondly, because of the limitations on the accuracy of the original data, the touch down points cannot be used without adjusting to actual field conditions. Lastly, there may be a need for cross sections at locations other than those produced in the plan. In that case, the surveyor will have to generate such sections from the information available elsewhere in the plan.

The information on the *cross section sheets* should be checked against the *construction plan, profile, superelevation, grading plan, and typical sections sheets*.

A – 4.0425 Bridge Plan

Bridge plans are usually let as separate plans. When let as separate plans, they contain a number of the items mentioned in *Section A – 4.04*. In addition, *bridge plans* provide the surveyor with the following information:

- A working point layout diagram that controls the entire layout of the bridge
- Dimensions between the working points
- General plan and elevation for the bridge
- Construction notes specific to items concerning the building of the bridge
- Summary of quantities for bridge materials
- Bridge typical section (shows the general layout of the lanes, shoulders, walkways, and railings for the bridge)
- Details of the bridge abutments, slope paving, piers, substructure, and footings
- Staging information if bridge construction is to be staged
- A bridge survey, done previously by Surveys, showing alignment, topography, and in place utilities

When a *bridge plan* is let separately, the alignment, profile, and typical section should be checked against the corresponding *construction plan*. Furthermore, information on the treatment for the bridge abutments is often included in the corresponding *construction plan*.

A – 4.0426 Standard Staking Sheets

The *standard staking sheets* delineate the staking requirements (intervals, information to include, type of staking, tolerance, abbreviations used) for a Mn/DOT construction project. AS mentioned in *Section 3*, these stakes are required not only to guide the construction, but also to assist the Mn/DOT inspector/engineer in performing QC/QA on the project. Unless prior arrangements are made, it should be assumed that these guidelines will apply to the construction staking for the project. (See *TAB - 2* for examples of these sheets.)

The *standard staking sheets* address the following staking situations:

- Slope stakes
- Bluetop stakes
- Curb & gutter stakes
- Utility stakes
- Pipe stakes
- Concrete paving stakes
- Alignment stakes
- Right of way and temporary easement stakes
- Guardrail stakes
- Overhead sign stakes
- Culvert stakes
- Wall stakes
- Clearing and grubbing stakes
- Bridge working points stakes
- Building foundation or footing stakes

A – 4.05 CONTROL

At the beginning of a project, Mn/DOT will provide information on the control that was established and used for the preliminary survey work in the project area. This control may consist of stations established by Mn/DOT's Geodetic Survey Unit (1st and 2nd order) or by the District (3rd order). Information on Geodetic control stations can be obtained from the Geodetic database via the web at <http://olmweb.dot.state.mn.us>. The respective District Surveys Office can provide information on control established by the District. It is the surveyor's responsibility to assure that the control datum is in agreement with the plan datum, both vertical and horizontal.

A – 4.0501 Horizontal Control

What Mn/DOT will provide for horizontal control is the coordinates of the control points, both northing, easting, and, if available, elevation; the point

numbers; the point names (we often name the points in reference to some landmark nearby); station and offset of the points to the plan alignment can be requested; the type of monument; a tie sheet if one was made for that point showing the location of the point in relation to surrounding topography; a horizontal control datum statement (on all new projects Mn/DOT is trying to go with the NAD '83 – '96 adjustment). This information may be available in either hard copy or as an electronic file.

To start the project, Mn/DOT will have in advance placed horizontal control monuments within the project area. The terrain of the area will dictate the spacing and also the setting of the monuments. This monumentation is what is to be used to start the construction staking.

The contractor's surveyor will be responsible for setting any additional control monuments for the project and they will be based on the original monuments that were provided. Verifying that the original control is correct is the responsibility of the contractor. Mn/DOT will provide the control and values for them to the best of our abilities but it is the contractor's responsibility to verify the values.

A – 4.0502 Vertical Control

Mn/DOT will provide a list of the Geodetic benchmarks in the project area. Mn/DOT will also provide any 3rd order benchmarks that have set. If there is a tie sheet for location of the benchmark, that will be provided. All elevations for the marks will be provided along with a datum statement (For all new projects Mn/DOT is trying to design those in NAVD '88.)

Verifying that the original benchmarks are correct is the responsibility of the contractor. Mn/DOT will provide the vertical control stations and values, but it is the contractor's responsibility to verify the values. As with the horizontal control, the contractor's surveyor will be responsible for establishing any additional vertical control required.

A – 4.06 RIGHT-OF-WAY

Mn/DOT will provide a hard copy of the plat or right-of-way map and, if it is available, an electronic file of the right-of-way. Accompanying the R/W Map or Plat will be a coordinate list of the right-of-way boundary corners, as well as the temporary easement points. This information, and not the R/W lines depicted on various sheets of the plan, must be used when staking the R/W. Please note that highway right-of-way lines are considered a property boundary. Staking of those points and lines must be done under the direct supervision of a land surveyor licensed by the Minnesota Board Of AELSLAGID. Unless specified otherwise, Mn/DOT will do final right-of-way monumentation under the direct supervision of a licensed land surveyor working for Mn/DOT.

A – 4.07 ELECTRONIC FILES AND SUPPLEMENTAL SOFTWARE

A – 4.0701 Plan Data Files

As mentioned previously, the construction plan will be available electronically as a Microstation® file. If the surveyor wishes to use this in another format,

such as AutoCad®, it will be the surveyor's responsibility to make the necessary conversion, assuring plan integrity is not compromised in the process.

Accompanying the Microstation® file will be one or more GeoPak® files. The GeoPak® files contain the plan points, chains, and profiles, as well as the R/W points, lines, and parcels. The GeoPak® files operate inside the Microstation® environment.

A – 4.0702 Mn/DOT Developed Survey Applications

Mn/DOT has developed a number of software applications to support the surveyor. Three that may prove of some use to the surveyor staking a construction project are:

- MNCON – a program that does conversions on data
- MNCOGO – a program that does coordinate geometry
- KEYSTAKE – a program developed by Mn/DOT that reads the redtop/bluetop reports generated by GeoPak® and gives the cuts or fills for those stakes

These, and other Mn/DOT developed programs are available free to the public at <http://olmweb.dot.state.mn.us>. Select “Data & Programs.” The surveyor using these programs does so at their own risk.

A – 4.08 SUMMARY

In summary, Mn/DOT will provide minor assistance with problem solving and, at the Mn/DOT inspector/engineer's request, will do spot checks on the staking that is done by the contractor. To assist the contract surveyor in staking the project, Mn/DOT provides a number of manuals and other publications. Mn/DOT will provide the original horizontal and vertical control on a project site, but additional control is the responsibility of the contractor. Mn/DOT will also provide the right-of-way and temporary easement information. Both a hard copy and electronic version of the construction plan, in Microstation® and GeoPak® formats, will be provided. Other software, developed by Mn/DOT is available to assist the contract surveyor.

Lastly, Mn/DOT sponsors an annual *Survey Technical Workshop*, where new survey techniques and technologies are presented, as well as discussions and information exchanges concerning current methods and equipment. (More information on the *Survey Technical Workshop* can be found at <http://olmweb.dot.state.mn.us>.)

A – 5 SCOPE-OF-WORK

A – 5.01 INTRODUCTION

Determining the scope-of-work for the surveyor on a construction project is not necessarily as straight forward a process as it may seem. While some tasks may be clearly identified, others may be implied as part of another task. Then too, there are those tasks that derive from common sense and the standards of practice of a prudent professional. The surveyor staking a construction project needs to consider all potential sources when determining the scope of what has been contracted for, and for which no additional compensation beyond the original contract price will be provided.

A – 5.02 SPECIFIED TASKS

Even in the case of clearly identified tasks, determining the scope-of-work may not be so easy. While the contract may include a section identifying “survey tasks” or “deliverables,” many specific survey tasks are identified under other headings.

For example, the *2000 Edition of the Standard Specifications for Construction* include specification *1508, Construction Stakes, Lines, and Grades*, which is usually referred to as the guiding directive for construction surveying. However, *1508* is not all inclusive. That is, not all specified construction survey tasks are listed under *1508*.

From the same publication, *2101.03 A* states that trees to be cleared and grubbed need to be marked (a specified survey task – staking the clear and grub limits or marking the individual trees.) The methods of determining which trees qualify, and how to pay for them are identified in *2101.04* (specified survey tasks of measuring tree size, counting trees, and computing acreages.)

The clear and grub situation provides just one example of how even specified survey tasks are not always readily apparent. Hopefully this example serves to educate the surveyor on the need to be familiar with all of the project documents and references discussed earlier in this *Appendix*.

A – 5.03 IMPLIED TASKS

Some survey tasks are not directly mentioned but, rather, are implied or assumed to be included as part of another task. This does not make them any less the Surveyor’s responsibility. Two examples follow to make the surveyor aware of how implied survey tasks come into play.

The project may require, usually in the *proposal* or *special provisions*, that the contractor verify the clearance of any crossing of proposed storm sewer over an existing utility. This may consist of excavating to the existing utility in order to obtain an in-place elevation that can then be compared to the proposed storm sewer elevation at that location.

While not directly identified as a required task, the Surveyor must mark the location of the proposed crossing. Furthermore, the Surveyor must obtain the in-place utility elevation and perform the necessary calculations to compare the obtained elevation to the proposed storm sewer elevation. An additional consideration: As a result of the excavation work, the original staking may be lost. Subsequent restaking for actual emplacement of the

storm sewer would not qualify for additional compensation beyond the original bid in this case.

The Surveyor is called upon to stake a catch basin. At a later date, while staking curb and gutter, it is found that the coordinates and top-of-casting elevation for the catch basin do not fit the proposed curb. Any rework required is at the surveyor's expense. A simple check between different components of the plan, *typical sections, alignment, profiles, superelevations, and drainage* would have revealed that an error existed. The need to crosscheck different components of the plan is an implied survey task. It is also covered under standards of practice of a prudent professional (Independent checks and verification are a staple of good surveying.)

As with specified survey tasks, situations involving implied survey tasks may appear throughout the project documents or reference materials.

A – 5.04 COMMON SENSE AND STANDARDS OF PRACTICE

Common sense and the standards of practice of a prudent professional provide another source of survey tasks that may not be directly specified, and for which no additional compensation beyond the original bid price will be provided. Two examples would be: Taking check shots on existing pavement at tie down points to assure that the planned project pavement will match. And, checking against a separate benchmark than the one used as a backsight when performing vertical work.

A – 5.05 SUMMARY

In order to prepare a bid that covers the majority of potential expenses, as well as to avoid any unpleasant surprises, the surveyor who plans to engage in Contractor staking should become familiar with all of the project documents and the reference mentioned elsewhere in *Appendix A*. While many projects will include a *special provision* (such as the example in *TAB – 1*) to cover Contractor staking, not all of the survey tasks will necessarily be found there. Some task may be specified elsewhere under documentation covering another aspect of the project. Additionally, many project elements include implied survey tasks. Lastly, the Surveyor must take into consideration the requirements of common sense and the standards of a prudent professional in determining what tasks may be required.

A – 6 END OF PROJECT SUBMITTALS

At the conclusion of a project, the surveyor will be required to provide mn/dot with certain information. Details as to the information required will be identified in either the *Contract* or the *SpecialProvisions* (see *tab – 1* for a sample of a *Apecial Provision* covering contractor staking.) The exact nature of the information required will vary depending on the type of project and district policy. However, at a minimum, the surveyor should be prepared to provide the following:

- Changes from the plan:
 - Alignment
 - Profile
 - Sewer
- Locations of utilities relocated or emplaced as part of the project

- Identify original monumentation destroyed during project
 - Alignment
 - Right-of-way
 - Property
 - Control
- New monumentation placed that is still present at project completion
 - Alignment
 - Right-of-way
 - Property
 - Control

The information should include the x, y and, if applicable, the z coordinates in the project datum. The information should be provided in both electronic (microstation® and geopak®) and hard copy format.

In the case of new monumentation, there should also be a report describing how the monumentation was placed. This will include copies of any fieldwork (traverse or leveling) as well as any adjustments used. It will also include tie sheets, to include a description of the physical object placed as the monument.

S - (2011) CONSTRUCTION SURVEYING

S – 1 GENERAL SURVEY SPECIFICATIONS

This contract provides for the Contractor to accomplish the Construction Surveying for this project. Mn/DOT Standard Specification 1508 is herewith modified to the extent that the Contractor shall meet all the requirements of, and provide all the services listed in, Specification 1508 which would otherwise be provided by Mn/DOT. Furthermore, in accordance with Mn/DOT Specification 1401, the Contractor is advised that the Contract may not fully describe every detail or make specific allowances for all probable exceptions and contingencies related to the Construction Surveying requirements for this project. Additional best management practices (BMP's) for Construction Surveying are identified in Appendix A of the Mn/DOT Surveying and Mapping Manual, in addition to the requirements shown below:

S – 2 SURVEYING TO BE PERFORMED BY MN/DOT

- 1) Mn/DOT will set the initial horizontal and vertical control points in the field for the project as indicated in the plans. Upon request, mn/dot will also provide electronic data on the control so established. This electronic data will be provided in the format that was used in the accomplishment of the surveys for the construction plan, and in construction plan development itself. However, due to the many different processes that the design survey data goes through and the large variety of sources of input in the final production of the plan itself, no warrantee is made as to the value or adaptability of the electronic data to the surveyor. No warrantee is made that the data systems used by Mn/DOT or any consultants employed by Mn/DOT for surveying or construction plan preparation will be compatible with the systems used by the contractor’s surveyor. Information shown on the printed “plan” shall always govern over any electronic “plan” data.

- 2) At the discretion of the Mn/DOT Engineer, spot checks may be performed upon the contractor’s surveying calculations, records, field procedures, and actual staking. If the engineer determines that the work is not being performed in a manner that will assure proper controls and accuracy, the engineer will order the contractor to redo such work, to the standards specified in the contract, at no additional cost to Mn/DOT.

If Mn/DOT sustains undue costs in checking excessive amounts of contractor construction surveying, or must perform survey work that is the contractor’s responsibility, the engineer may deduct Mn/DOT’s cost from monies due or becoming due the contractor in accordance with the following rates:

	<u>Hourly Rates</u>
Registered Engineer or Licensed Land Surveyor	\$ 80.00
4-person crew and equipment	\$240.00
3-person crew and equipment	\$180.00
2-person crew and equipment	\$125.00
1-person with equipment	\$ 75.00

or as incurred by Mn/DOT should it become necessary, due to Mn/DOT resource commitments, to have such work performed by a consultant under contract to Mn/DOT.

- 3) Mn/dot will measure the following pay quantities:

(list those pay quantities that mn/dot will measure here.)

Alternatively use, "mn/dot will measure all of the pay quantities except the following:

(list those pay quantities that will not be measured by mn/dot but are to be measured by the contractor, here.)

- 4) Mn/dot will be responsible for setting the following final monumentation:
(remove those that will be placed by the contractor.)

Horizontal control

Vertical control

Alignment

Right-of-way

S –3 CONSTRUCTION SURVEYING BY THE CONTRACTOR

- 1) Contractor Construction Surveying Requirements

Construction Surveying is defined as accurately providing all necessary computations, stakes and marks to establish lines, slopes, elevations, points, continuous profile grades in accordance with Mn/DOT 1508 and the requirements shown in the Plan for Construction Staking; so that the Contractor's forces are able to construct all required work for the project in accordance with the Contract requirements; and so that Mn/DOT Engineers and Inspectors are able to complete all necessary inspection and Contract Administration duties. The staking shall include, but not be limited to, clearing and grubbing, removals, grading, culverts, embankments, borrow, aggregate base course, pavements, bridges, utilities, signs, pavement markings, erosion control and turf establishment items to complete the project as represented in the plans. The Surveying must be done in a way that is timely, and that is reflective of the continuing and ongoing nature of construction and inspection activities which will generally require frequent, separate project visits by the Contractor's survey crew to the project to accommodate the various stages of construction and inspection activities that will occur.

The Surveyor shall be prepared to make all necessary surveying checks for field verification of actual conditions and shall make the necessary minor surveying and staking adjustments to fit the construction to actual field conditions. In addition, some Plan details may be dependent upon actual field conditions at the time of construction. It may be necessary to perform some field survey or office computations in order to stake these components. All work referred to in this paragraph is considered part of the work of Construction Surveying and no additional payment will be made for this work.

The Contractor shall retain a Professional Land Surveyor or Professional Engineer, licensed in the State of Minnesota, to directly supervise the Construction Surveying.

Any determination of, or marking of, right-of-way must be performed under the supervision of a Licensed Land Surveyor. Additionally, for those projects let after 31 August 2007, an individual holding a NSPS - ACSM Level III certification in Construction Surveying, an LSIT, or a licensed Surveyor/Engineer, shall be on the Project site at all times to directly supervise the survey crew(s).

The Contractor shall:

- A) Be responsible for the preservation of all reference points, monuments, government land corners, horizontal and vertical control points, stakes, and marks that are established by Mn/DOT or others within the project limits. If the Contractor or its surveyor fails to preserve these items and if they must be reestablished by Mn/DOT, the Engineer will deduct a charge from monies due or becoming due the Contractor according to the Department's costs as shown elsewhere in these special provisions.
- B) Be responsible to review, balance, adjust, correct, and investigate Mn/DOT provided data and to perform work on survey data and control points that may be necessary to use the survey points and data, all at no extra cost to Mn/DOT, unless it is determined by the Mn/DOT Engineer that latent errors existed in the information provided by Mn/DOT.
- C) Start and end all level runs, traverses, or GPS control surveys, from known control. Complete all control surveys at no worse than the standards specified for supplemental control in Chapter 2, Mn/DOT Surveying and Mapping Manual.
- D) Unless otherwise agreed to, set all stakes and marks in accordance with the Staking Information Sheets included in the Plan.
- E) Furnish and install traffic control devices in accordance with the Field Manual for Temporary Traffic Control Zone Layouts, Part VI, (MN MUTCD), when crew members are exposed to traffic.
- F) Perform all Construction Surveying for all project construction as shown in Mn/DOT 1508, and shall install reference points as needed for the use of any public utility crews that are staking or accomplishing utility relocation or construction associated with this Contract.
 - a. From Horizontal and Vertical Control Points established by the Engineer.
 - b. According to the Plan, Proposal and Standard Specifications.
 - c. According to the Mn/DOT Surveying and Mapping manual.
 - d. According to actual existing field conditions.
- G) Perform Bridge and Structure Construction staking which includes setting and reestablishing Working Points and Reference Points by XYZ coordinates to provide line and grade during all stages of work, and at all substructures and segments of Bridge or Structure Construction, as shown below:

- a. Establish Working Points or Reference Points, approved by the Engineer, on the ground as shown on the Bridge Layout sheet in the Plans.
 - b. Transfer of required points from the ground to the top of footing after completion of concrete footing construction. If the structure is a curved wall or bridge edge of slab, curb, coping, median, or railing, the Contractor's Surveyor shall mark a curved line on the footings, forms, or deck slab, to the proper degree of curvature within 1/8" in ten (10) feet, as needed for construction and inspection activities.
 - c. Transfer required points to the top of all finished structures.
 - d. Transfer required points to the superstructure deck forming. (Mn/DOT personnel will complete all work associated with beam stool elevations.)
- H) Bear all costs, including but not limited to the cost of actual reconstruction of Contract work, that may be incurred due to errors in Contractor's Construction Surveying.
- I) Document surveying during construction in a form acceptable to the Engineer and allow the Engineer access to surveying notes and calculations. The survey documentation includes:
- a. Control station monumentation with reference ties.
 - b. Field notes that were used to set construction stakes, control the Project, and document monument locations. The Contractor shall use bound, hard cover field books for recording survey data and field notes; store field notes on an electronic medium; or use both methods. If an electronic medium is used, the raw field data files must be available. When using an electronic medium, the Contractor shall make all files and data available in the Standard formats used by the Department.
- J) Present the Engineer with the as-built Survey Data. The as-built Survey Data shall include the following:
- a. Changes from the Plan
 - i. Alignment
 - ii. Profile
 - iii. Sewer
 - iv. (List other items as desired)
 - b. Locations of utilities relocated or emplaced as part of the project
 - c. Identify any alignment, right-of-way, property, or control monumentation destroyed during the project
 - d. Any alignment, right-of-way, property, or control monumentation that was placed during the project and that still exists at project completion.
 - e. The information shall include the x, y and, if applicable, the z coordinates in the project datum. If the original item had no coordinate reference, then show the revised centerline station and offset.
 - f. The information shall be provided in both electronic (Microstation® and GeoPak®) and hard copy format.

percentage of Construction Surveying accomplished, as determined by the Engineer, up to 90 percent of the lump sum bid price. The Contractor will receive the final 10 percent of the lump sum bid price when the survey computations, notes, miscellaneous documents, and as-built Survey Data as specified have been received and accepted by the engineer within the time limits specified by the Survey Work Schedule. If the Contractor fails to provide acceptable documentation and the as-built Survey Data within the time limits specified, Mn/DOT reserves the right to reduce the lump sum payment for Contractor Construction Surveying by a percentage of up to 10 percent of the lump sum bid price.

2) Payment for Extra Work

When the Engineer determines that extra or additional Construction Surveying beyond the scope of the original Contract is required and orders the Contractor to accomplish this work, compensation will be made as Extra Work in accordance with Mn/DOT 1904 and at the same rate shown for a Mn/DOT survey crew above. If the Construction Surveying is accomplished by a subcontract, the prime Contractor allowance will be five (5) percent.

3) Payment

Payment for Construction Surveying will be made on the basis of the following:

Item No.	Item	Unit
2011.601	Construction Surveying	Lump Sum

APPENDIX B – PERTINENT MN/DOT POLICIES

B – 1 MN/DOT “CERTIFICATE OF LOCATION OF GOVERNMENT CORNER” POLICY

B – 2 OBLITERATED PROPERTY MONUMENTS

B – 3 DEPARTMENT POLICY REGARDING TRUNK HIGHWAY RIGHT-OF-WAY

Mn/DOT CERTIFICATE OF LOCATION OF GOVERNMENT CORNER

Please read and consider the attached Mn/DOT Policy for “Certificate of Location of Government Corner” with the following perspective in mind. (Note: in the following, when reference is made to the “County Recorder or County Surveyor....” Such reference applies only to cases where the Public Land Survey System PLSS corner will not be disturbed by Mn/DOT construction. As per a decision by the Attorney General, A “Certificate of Location of Government Corner” for a PLSS corner replaced because of Mn/DOT action must be filed with the County Recorder as per M.S. 160.15.)

In order for Mn/DOT Land Surveyors to maintain the image of being the best in the State of Minnesota, we must use good judgment, be diligent, and thorough in our search when working with government corners. The certificate of location is the written record of the present condition and history for the PLSS corner. Therefore, to be useful for posterity the document must be properly completed, provide the best location in the opinion of the Land Surveyor, and assure the total perpetuation of the corner when made of public record with the County Recorder, or the County Surveyor where the county maintains a full-time Surveyor’s Office. A County Surveyor’s monument does not relieve the surveyor of an obligation to seek the best evidence of a corner’s location (see the section on “County Remonumentation Programs,” page 5.) A monument without a history is of little value as evidence and a new monument is worthless if it cannot be identified in the future.

Prior to a land corner certificate being filed with the County Recorder, or the County Surveyor where the county maintains a full-time Surveyor’s Office, it will be submitted to another Licensed Land Surveyor within Mn/DOT for review. The review will be in the form of an evaluation of the decisions embodied in the certificate as well as the document itself. The results of the review will be provided to the District/Division Surveyor in the form of comments or suggestions.

The District/Division Surveyor shall take the comments and suggestions into consideration and incorporate any corrective action the surveyor thinks may be required. The Professional Surveyor that signs the “Certificate of Location of Government Corner” shall be responsible for the content and decisions incorporated into the certificate. Therefore, the final decision about the appropriateness of the document will be the responsibility of the surveyor signing the certificate.

After the “Certificate of Location of Government Corner” is filed with the County Recorder, or the County Surveyor where the county maintains a full-time Surveyor’s Office, a copy of the document will be submitted to the Central Office Platting Unit. The District/Division Surveys Office will create a report containing: the certificate, the recording data, and the information used to complete the certificate such as detailed excavation report, corner analysis, additional witness testimony, photographs, etc. (For more information on this report, see page 9.) This report will be maintained in the District/Division Surveys Office files. In the case where a “Certificate of Location of Government Corner” prepared by someone else has been accepted, an annotated copy (see the section on “County Remonumentation Programs,” page 5) of such certificate shall be maintained in the report.

Mn/DOT CERTIFICATE OF LOCATION OF GOVERNMENT CORNER**MN/DOT Policy
FOR
CERTIFICATE'S OF LOCATION OF GOVERNMENT CORNER**

Minnesota Statute 160.15 follows:

160.15 MS 1953 [Repealed, 1957 c 943 s 72]

160.15 PRESERVING SECTION OR QUARTER-SECTION CORNERS.

Subdivision 1. **Permanent marking of corners.** Whenever the construction, reconstruction, or maintenance of a public street or highway causes the destruction or obliteration of a known section or quarter-section corner marker or monument, the road authority having jurisdiction over the highway or street shall provide for the permanent marking of the corners and place reference or witness monuments so that the corners can be readily located.

Subd. 2. **Manner of placement.** The permanent marking of the corners and establishment of reference or witness monuments must be in the manner following: At the exact location of the corner there must be placed a durable stone, concrete, or metal marker, placed so as not to be disturbed by routine maintenance activities. For a paved highway, a supplemental marker must be placed over the durable monument. The supplemental marker must be visible at the road surface and set in a manner so as not to be disturbed by routine snow plowing. When not practical or safe to set a corner marker in a highway surface, a durable metal marker may be set as a permanent witness monument on the section line or quarter-section line.

Subd. 3. **Time of placement; monument of durable material.** Reference or witness monuments evidencing the location of the corner must be established before the obliteration of the corner in at least two places most practicable and shall consist of stone, concrete, or cast iron.

Subd. 4. **Filing of certificate.** The land surveyor placing and establishing the markers or monuments shall, no later than one year after placing and establishing them, file a certificate to that effect in the office of the county surveyor, if the county maintains a full-time office, in the county or counties in which the markers or monuments were placed. If a county in which the markers or monuments were placed does not have a full-time office of the county surveyor, then the land surveyor shall record the certificate in the office of the county recorder of that county. Each certificate must contain only the record of markers and monuments at one corner.

Subd. 5. **Contents of certificate.** The certificates must be on sheets of durable material, which must be 8-1/2 by 11 inches with a margin at the left for binding. The certificates must contain the following:

- (1) identification of section or quarter-section corner;
- (2) description of monument removed;
- (3) description of replacement monument;
- (4) reference ties or witness monuments;
- (5) statements relating to physical and parol evidence relating to history and authenticity of the corner monument;
- (6) date of remonumentation; and
- (7) certification by a registered land surveyor.

Mn/DOT CERTIFICATE OF LOCATION OF GOVERNMENT CORNER

Subd. 6. **Cost of placing markers.** The cost of placing the markers and monuments, including filing fees, must be paid out of the respective funds provided by law, or set aside for highway or street purposes.

History: 1959 c 500 art 1 s 15; 1971 c 598 s 1; 1973 c 123 art 5 s 7; 1976 c 181 s 2; 2004 c 154 s 1; 2005 c 99 s 1

Copyright © 2006 by the Office of Revisor of Statutes, State of Minnesota

Whenever we destroy or obliterate a PLSS marker or monument it is our duty to place new monuments so the corner can be readily located. We must use a specific monument and place it at the proper location. Each PLSS corner monument must have at least two reference ties. A Certificate, for each PLSS corner, shall contain specific information about the corner. Any required filing fee shall be paid out of funds set aside for highway purposes.

Therefore, all PLSS monuments that are within or near the highway right of way line must be perpetuated with a "Certificate of Location of Government Corner." The Certificate must be a complete document relating to the location, monumentation, perpetuation and history of the corner.

It is understood that in some counties, the County Surveyor accepts sole responsibility/authority to replace government corners. In such counties, it is the responsibility of the District/Division Surveyor to notify the County Surveyor as soon as a corner has been identified as "threatened." Furthermore, under M.S. 381.12, the County Surveyor is responsible for perpetuating and monumenting PLSS corners when so requested. Because limited staffing in the county may lead to long lag times in providing such monumentation, the District/Division Surveyor must request such corners as soon as their need has been identified. If the County Surveyor is unable or unwilling to respond in time, it is the responsibility of the Mn/DOT Surveyor to assure that corners needed for program development/delivery are properly perpetuated.

While M.S. 160.15 refers to corner monuments destroyed by Mn/DOT projects, it is Mn/DOT policy that it is the responsibility of the District/Division Surveyor to provide for the perpetuation of all land corners, referenced by Mn/DOT projects, within the District/Division. The perpetuation will comply with the guidelines indicated in the attached "Instructions for Certificate of Location of Government Corner" (see page 8.)

PLATS

All PLSS corners required and/or indicated on any monumentation or acquisition plat shall be properly documented by having a "Certificate of Location of Government Corner" prepared and filed with the County Recorder, or the County Surveyor where the county maintains a full-time Surveyor's Office, consistent with M.S. 160.15. All PLSS corner certificates shall be filed prior to any plat being recorded.

The District/Division Surveys Office will create a report containing: the certificate, the recording data, and the information used to complete the certificate. This report will be maintained in the District/Division Surveys Office files. In the case where a "Certificate of Location of Government Corner" prepared by someone else has been accepted, an annotated copy (see the section on "County Remonumentation Programs," page 5) of such certificate shall be maintained in the report.

Mn/DOT CERTIFICATE OF LOCATION OF GOVERNMENT CORNER

RIGHT OF WAY LOCATED BY REFERENCE TO SUBDIVISION PLAT

In some cases involving minor projects with small acquisitions it may be advisable to write real estate legal descriptions based on subdivision plats that are on file and of record in the County Recorder's Office or the County Registrar's Office. When the District/Division Surveyor uses a subdivision plat for the description all necessary lot, block and or plat monuments needed shall be recovered in the field. The District/Division Survey Office shall create and maintain a report describing such subdivision plat and monuments so used. This report will be maintained in the District/Division Surveys Office files.

OTHER BOUNDARY SURVEYS

All PLSS corners required to properly locate any new or existing legal description shall be appropriately documented by having a "Certificate of Location of Government Corner" prepared and filed with the County Recorder, or the County Surveyor where the county maintains a full-time Surveyor's Office.

Please keep in mind that our goal is to correct any shortcomings in our past land corner perpetuation procedure. Therefore, the Certificates should address and clarify any discrepancy with old information.

In some cases a thorough and professional job of land corner perpetuation may be impractical. An example of this could be the land corners needed to describe new right of way for a small culvert extension. In these exceptional cases the District/Division Surveyor shall complete and maintain a report defining the monumentation such right of way is tied to. Every effort must be made to avoid this procedure as a common practice.

Note: Please refer to the pages dealing with "County Remonumentation Programs" (page 5) and "Land Corner Perpetuation" (page 6) for standards and requirements when using County Surveyor PLSS corner monuments.

All "Certificates of Location of Government Corner" required for narrative type real estate legal descriptions must have a report containing: the certificate, the recording data, and the information used to complete the certificate. This report will be maintained in the District/Division Surveys Office files. In the case where a "Certificate of Location of Government Corner" prepared by someone else has been accepted, an annotated copy (see the section on "County Remonumentation Programs," page 5) of such certificate shall be maintained in the report.

COUNTY REMONUMENTATION PROGRAMS

Some counties have active remonumentation programs. When the County Surveyor has completed an extensive Statement of Evidence, in conjunction with the remonumentation, a new statement of evidence may not be needed. When a "Certificate of Location of Government Corner" has been filed for record in the County Recorder's Office, or the County Surveyor's Office where the county maintains a full-time Surveyor's Office, a District/Division Surveyor may obtain a copy of said Certificate for review. A new Certificate may not be required (see below.)

In some cases a County Surveyor may have compiled information and documentation, about a needed land corner, and not prepared a "Certificate of Location of Government Corner." In these cases a "Certificate of Location of Government Corner" must be prepared and filed with the County Recorder, or

Mn/DOT CERTIFICATE OF LOCATION OF GOVERNMENT CORNER

the County Surveyor where the county maintains a full-time Surveyor's Office. (See also, the Addendum at the end of this policy.) A copy of the Certificate shall be submitted to another licensed land surveyor within Mn/DOT for review before being filed.

When a "Certificate of Location of Government Corner" has been properly prepared by a Licensed Land Surveyor it may be used under the following conditions:

1. A field review of the site has been made.
2. If the information on the old Certificate is substantially correct and in compliance with the "Instructions for Certificate of Location of Government Corner" requirements (see page 8), a new Certificate will not be required. If a copy of the Certificate has not been filed for record with the County Recorder, or the County Surveyor where the county maintains a full-time Surveyor's Office, it must be filed before a Mn/DOT plat is filed or a legal description is written.
3. The District/Division Surveyor will submit a copy to the Central Office Platting Unit of the "Certificates of Location of Government Corner" that were completed by others. Each such certificate shall be annotated with the following:
 - a. A statement indicating that the surveyor has reviewed the Certificate, that it is correct, and the surveyor accepts the monument as the location of the land corner.
 - b. The surveyor's signature and license number.
4. When the New Certificate is prepared the "Statement of Evidence" may indicate that the evidence is the same as was previously recorded by listing the book and page of the previous document in the "Statement of Evidence." Some other forms of documentation may also be permissible when enumerated in the "Statement of Evidence."

LAND CORNER PERPETUATION (M.S. 160.15)

During the course of any reconstruction, resurfacing or maintenance of a highway, any and all physical monuments, that represent the location of a land corner that will be disturbed, shall be perpetuated by having a "Certificate of Location of Government Corner" prepared and filed with the County Recorder. The work should be done in conjunction with the construction; before any new surface is placed. If there is a change in the monument or its ties due to the construction, a new certificate must be filed at the completion of the construction. Every effort must be made to perpetuate all land corners.

If the County Surveyor has replaced the monument and completed a "Certificate of Location of Government Corner," the District/Division Surveyor will obtain a copy of the Certificate for his evaluation, review, and records.

Mn/DOT CERTIFICATE OF LOCATION OF GOVERNMENT CORNER

The responsibility for perpetuating land corners within the right of way of trunk highways may be assumed by a County Surveyor when all of the following conditions are met:

1. The County has a full time surveyor who is willing to assume the responsibility for the monument perpetuation and documentation required at no cost to the state. A copy of the letter from the County Surveyor assuming this responsibility must be on file in the District/Division Surveys Office.
2. The County Surveyor will complete a "Certificate of Location Government Corner." Said Certificate must comply with MN/DOT standards or County Standards that are mutually acceptable.
3. The Original copy of the "Certificate of Location of Government Corner" must be filed with the County Recorder. A copy must be provided for MN/DOT records as well as submitted to the Central Office Platting Unit.

LAND CORNER RESEARCH RECORD

All Physical evidence of a PLSS corner must be perpetuated; even those of questionable authenticity. For possible monuments of a PLSS corner that will not be used as a land tie, apply the following procedure:

If one or more monuments are found in the general area of a PLSS corner each of them must be perpetuated. The history and reputation of each monument should be researched and listed in the Statement of Evidence. If an analysis of the evidence indicates one of the monuments marks the correct location of the PLSS corner, please indicate the pertinent information and decisions in a conclusion or summary statement. In this case a copy of the "Certificate of Location of Government Corner," showing the relationships of all monuments, shall be filed in accordance with the procedures previously described.

If any analysis of the evidence indicates that the history and reputation of the monuments is incomplete and inconclusive the District/Division Surveyor will still do a "Research Record " for the location. The "Research Record" may be in pencil and should include any available evidence. The person that completes the sketch and/or the statement of evidence will sign on the backside of the form.

The "Research Record" will be kept in a report on file in the District/Division Surveys Office along with any collateral information. The "Research Record" will not be filed with the County Recorder.

The copy of the "Research Record" (with any collateral information such as detailed excavation report, corner analysis, additional witness testimony, photographs, etc see page 9), will be shared with the public upon request. When the information is released to the public the following disclaimer shall be stamped or written on the face of the Certificate:

"The information on this Research Record may be incomplete and inconclusive. An in-place monument was merely perpetuated. If you have questions, please contact the District/Division Surveys Office of the Minnesota Department of Transportation".

Mn/DOT CERTIFICATE OF LOCATION OF GOVERNMENT CORNER**INSTRUCTIONS FOR “CERTIFICATE OF LOCATION OF GOVERNMENT CORNER”**

The Certificate of Location should be a complete document relating to the location, monumentation, perpetuation, and history of a corner. If done properly, the need for future surveyors to research the past record evidence will be eliminated. The following outline provides guidelines for preparation of the Certificates.

I. CORNER INDEX SYSTEM

- A. Identify corner in section where the corner is the North Quarter, Northeast or East Quarter corners.
- B. Identify corner in the proper section if on standard parallel or correction line.
- C. If a corner is on a county line it should be identified and filed in each county in proper section.
- D. List section, township, range, principal meridian and county.

II. MONUMENT

- A. Check the appropriate statement on Certificate for monument at corner location.
- B. Indicate date of recovery and/or placement of monument.
- C. Describe the monument in detail and give relationship to ground elevation.
- D. If a monument is removed, during construction or for other purposes, explain fully under statement of evidence (on back of page).

III. SKETCH OF REFERENCE TIES

- A. Make a minimum of three ties, if practicable.
- B. Identify the reference points in detail, e.g.; nail and disc on S.W. side of 20' burr oak, 2 feet above ground.
- C. Reference tie distances are horizontal unless clearly stated on sketch. Show difference in elevation and direction of slope for slope measurements.
- D. Direction of reference point from corner should be given by:
 - 1. Point of compass i.e., N, NNE, NE, ENE, E, etc. or
 - 2. By a bearing, i.e., N50 E. For bearings indicate on sketch their basis of orientation and accuracy.
- E. Show the improvements in the immediate vicinity such as roads, including name or number, buildings, fences, tree lines, retaining walls, field lines, and their relation to corner.
- F. Indicate Standard Parallel or Correction Line.

IV. STATEMENT OF EVIDENCE

- A. Include all record evidence that relates to the history of this corner chronologically beginning with Public Land Survey.
- B. Include all parol evidence and testimony concerning corner location. List name, age, residence, address, job title, and how information was obtained.
- C. Include all information on field search and excavation. Indicate extent and depth of excavation; soil profile, characteristics; present and original ground elevations could be added.
- D. Include information on monument found in place. Identify type and size of monument; who, when and how it was placed in addition to a photo. Indicate in

Mn/DOT CERTIFICATE OF LOCATION OF GOVERNMENT CORNER

statement of evidence if no information is found on the origin or history of monument.

- E. Method used to set lost or obliterated corners must be stated in a short summary with supporting evidence.
- F. When a coordinate value is known, the coordinates may be listed. If the coordinates are enumerated, the reference coordinate system must be indicated.
- G. Analyze all of the information on the document. Indicate the reasons for the decisions made in the form of a summary or conclusion statement.

V. PLSS CORNER REPORT

- A. Each corner shall have a report on file in the District/Division Surveys Office.
- B. The report shall include:
 - 1. A copy of the current/most recent certificate on file. Annotated as indicated above if accepting another's certificate.
 - 2. The recording information for the above certificate.
 - 3. Information used to evaluate the corner monument accepted/placed such as detailed excavation report, corner analysis, additional witness testimony, photographs, etc.
 - 4. Results of the independent certificate review.
 - 5. A copy of the letter from the County Surveyor assuming responsibility if appropriate.
- C. Multiple corners may be included in a single report if there is a logical connection (for example, corners in the same or adjoining sections or along the same corridor.)

ADDENDUM: FULL-TIME COUNTY SURVEYOR ACCEPTING RESPONSIBILITY

In those counties that have a full-time County Surveyor who is willing to accept responsibility for the PLSS corners, the following procedure may be used to "certify" corners for right of way work. It must be noted that this does not relieve the Mn/DOT Surveyor of their statutory responsibilities under M.S. 160.15 for PLSS corners that will be obliterated or destroyed by Mn/DOT projects.

- 1. The County Surveyor must provide the District/Division Surveyor with an official letter stating that he, the County Surveyor, accepts responsibility for perpetuating the PLSS corner to include monumentation and documentation. Whenever a new County Surveyor comes into office, this letter must be issued anew, reaffirming that the County Surveyor still supports this policy.
- 2. The District/Division Surveyor will obtain from the County Surveyor a sheet identifying the PLSS corner, the monument marking its location, and the ties to the monument.
- 3. A copy of the above mentioned County Tie sheet, along with a copy of the letter from the County Surveyor, will be sent to the Central Office Platting Unit. The County Tie Sheet will be annotated with the statement, "I have verified this monument and ties in the field and hereby accept this as the location of the PLSS corner identified." This will be followed by the Mn/DOT Surveyor's signature and license number. Another such annotated copy will go in the "PLSS Corner Report" (see page 9) kept in the District/Division Surveys Office.

The following policy regarding the restoration of private property monuments obliterated by Mn/DOT construction projects is taken from the Mn/DOT RIGHT OF WAY Manual.

OBLITERATED PROPERTY MONUMENTS

POLICY

Property corner monuments within or on Mn/DOT right of way lines (permanent and temporary) and that are outside the construction limits should be designated in the construction plan to be protected. If these designated monuments are destroyed by the contractor, Mn/DOT should deduct \$300.00 from monies due the contractor and hold the contractor responsible to “restore damaged property corner to a condition equal or better than existing before the damage was done” (see Mn/DOT Standard Specifications for Construction, Specification Numbers 1712.1 to 1712.4 and 1714).

PROCEDURE

The following guidelines, in descending order, are the recommended procedures for dealing with property corner monuments that may be or have been obliterated during the construction process.

- A. All property corners within or on the right of way lines (permanent or temporary) will be searched for and tied into the county coordinate system.
- B. The field title investigator will inquire of the owner as to evidence of physical existence of these property monuments (certificates of survey, etc.). This data will be given to the Mn/DOT District Surveyor for further investigation. The property monuments that are deemed valid by the Mn/DOT District Surveyor should be recommended by the District Right of Way Engineer/Land Management Supervisor to be treated as a “cost to cure” in the appraisal.
- C. When a property owner contacts Mn/DOT regarding obliterated property monuments, Mn/DOT will investigate records to determine if the monuments actually existed and if compensation was previously made by Mn/DOT. If the monuments existed, no payment was made, and they were obliterated, the owner should be compensated \$300.00 (or reasonable surveyor’s estimate) per monument to reset the monuments. Mn/DOT will provide survey data it has for remonumentation to be done.
- D. When no documentation of the property monuments exist, Mn/DOT will decline monumentation claims.
- E. The District may, at their discretion, reset known obliterated property corners. This decision should be based on the reputation and positional quality of these monuments.
- F. On projects where there is extensive obliteration of property monuments (usually in subdivided areas), the District may elect to contract a private licensed Land Surveyor to reset the obliterated monuments in lieu of paying compensation. This may be a more cost effective approach.

Department Policy Regarding Trunk Highway Right of Way

The following Policy Memo (ENGINEERING Memorandum, design & right of way division, surveying & mapping no. 76-2) Represents Mn/DOT policy regarding the location of Right-of-Way acquired by "centerline description."

ENGINEERING MEMORANDUM
DESIGN & RIGHT OF WAY DIVISION
SURVEYING & MAPPING NO. 76-2

TO : District Engineers
Assistant District Engineers
Resident Engineers
Project Engineers
District Right of Way Engineers
District Survey Engineers
District Land Surveyors

Distribution: 57D

FROM : William C. Merritt
Deputy Commissioner & Chief Engineer

SUBJECT: Department Policy Regarding Trunk
Highway Right of Way



The following policy statements were approved at the August 23, 1976 Cabinet meeting:

The right of way that is occupied and/or monumented represents the property that was viewed, appraised, to which rights were acquired, and is the property that the Department will claim.

In the case where the description of record does not fit the occupied right of way, the Minnesota Highway Department will rectify the description of record by the necessary means to make it conform to the right of way as occupied and/or monumented.

Comments:

Paragraph 1 should be followed for all requests to stake right of way as purchased by centerline descriptions.

Paragraph 2 should be implemented for those cases initiated by outside interests requiring rectification of the right of way description to the in-place location. The offices of Right of Way and Surveying and Mapping will work out a procedure for correction of the description of record.



William C. Merritt
Deputy Commissioner & Chief Engineer
Design & Right of Way Division
Surveying & Mapping
Room 711

In order for this policy to apply, it is necessary to perform the necessary field and record analysis to verify that the centerline of the road as-built conforms to the centerline used to acquire the Right-of-Way.